

secom

here comes the light



67

Lighting Systems
Systèmes d'éclairage

GENERAL CATALOG / Price list
CATALOGUÉ GÉNÉRAL / Tarif de prix

secom
here comes the light

67

General Catalog / Price list
Catalogue Général / Tarif de prix



Head Office Molina de Segura (Murcia, Spain)
Siège de Molina de Segura (Murcie, Espagne)



Assembly instructions, quality certificates, technical specification sheets and eulmdat files available to download from our site:

www.secom.es

Instructions de montage, certificats de qualité, fiches techniques et fichiers eulmdat disponibles à télécharger sur notre site:

www.secom.es

secom ILUMINACIÓN S.L.

Polígono Industrial La Estrella. C/ Marte 18-21
30500 Molina de Segura (Murcia) Spain
Buzón de Correos nº11
Tlf.: 968 80 12 11 • Fax.:968 89 10 48
secom@secom.es

Dpto.Exportación
Tlf.: ++34-968 80 16 88 • Fax.: ++34-968-60 34 49
export@secom.es

www.secom.es



secom
here comes the light



Corporate Video Secom
Vidéo d'entreprise Secom

Lighting is a skill, technology and innovation but also sensitivity, originality and soul.

Secom was founded in 1989, and its committed to adding value at every stage of the lighting market.

Secom Lighting focuses their activities in the design, manufacture and marketing of different types of fittings and light sources.

Secom has reached a leading position in the European lighting industry, thanks to its closeness with architects, engineers, wholesalers, installers and end users, Secom is listening and picking up each of their suggestions and its incorporating them into the design plans, eventually creating fittings that perfectly meet all needs. Secom currently sells fittings all over the world, generating directly and indirectly above 500 jobs.

Secom, in its 14,900-sqm facilities located in Molina de Segura (Murcia, Spain), carries out all production processes, and keeps large stocks of components involved in the manufacture of lighting equipment, in order to achieve greater flexibility and a reasonable delivery time.

Secom business philosophy focuses on getting high quality fittings, with European top brand components for high reliability, and reasonable prices.

Secom confers great importance to reduce time and storage costs of its distributors, therefore, carries out a careful and attractive packaging process, making the piling process easier thanks to its polyhedral lines and plenty of technical information. The fittings are also intended to take a short installation time, thus reducing labour cost. Finally, for both prescriptors and final clients, Secom specially cares for the esthetic side of the fitting, light control and efficiency.

Secom, at the forefront of technology with a professional R&D department, has incorporated the latest and machinery for the development and manufacture of light fittings. One of its recent acquisitions is the necessary equipment to manufacture and assemble the entire LED circuit and LED lights, enabling the company to deal with the increasingly strong demand for this type of fittings, more and more efficient and environmentally friendly.

L'éclairage est des compétences, la technologie et l'innovation mais aussi la sensibilité, l'originalité et l'âme.

Secom Iluminación a été fondée en 1989, et se engage à ajouter de la valeur à chaque étape du marché de l'éclairage.

Secom éclairage concentre ses activités dans la conception, la fabrication et commercialisation de divers types de raccords et de sources lumineuses.

Secom a atteint une position de leader dans l'éclairage européenne l'industrie, grâce à sa proximité avec les architectes, les ingénieurs, grossistes, installateurs et clients finaux, son écoute et la cueillette jusqu'à chacune de leurs suggestions et de son les incorporant dans le plans de conception, voire de créer des accessoires qui satisfont parfaitement tous désirs et besoins. Secom vend actuellement ses accessoires partout dans le monde, générer directement et indirectement plus de 500 emplois.

Secom, dans ses installations 14900-m² situé dans Molina de Segura (Murcia, Espagne), effectue tous les processus de production, et maintient grande stocks de composants impliqués dans la fabrication d'éclairage l'équipement, afin d'atteindre une plus grande souplesse et un raisonnable délai de livraison.

Philosophie d'entreprise Secom concentre sur l'obtention de haute qualité raccords, avec les meilleurs composants de marque de l'Europe pour une grande fiabilité, et des prix raisonnables.

Secom attache une grande importance pour réduire le temps et le stockage coûts de ses distributeurs, donc, effectue une attention et attrayant processus d'emballage, ce qui rend le processus d'empilage plus facile grâce à son lignes polyédriques et beaucoup d'informations techniques. Les raccords sont également destiné à prendre un temps d'installation court, réduisant ainsi le travail coût. Enfin, pour les deux prescripteurs et clients finaux, en particulier Secom se soucie pour le côté esthétique de la, le contrôle et l'efficacité lumineuse.

Secom, à la pointe de la technologie avec un professionnelle I+D+i département, a intégré la dernière et la plus moderne mécanismes pour le développement et la fabrication de luminaires. Une de ses récentes acquisitions est l'équipement nécessaire à la fabrication et assembler le circuit LED entier et lumières LED, permettant à la entreprise à faire face à la plus forte demande pour ce type de raccords, de plus en plus efficace et plus respectueux de l'environnement.



Sales management. Gestion des ventes.

Robotized warehousing system. Système de stockage robotisé.



Aluminum injection machine. Aluminium machine d'injection.



Cutting and engraving laser of PMMA. Découpe et gravure au laser de PMMA.



Robotized wiring cell. Cellule de câblage robotisé.



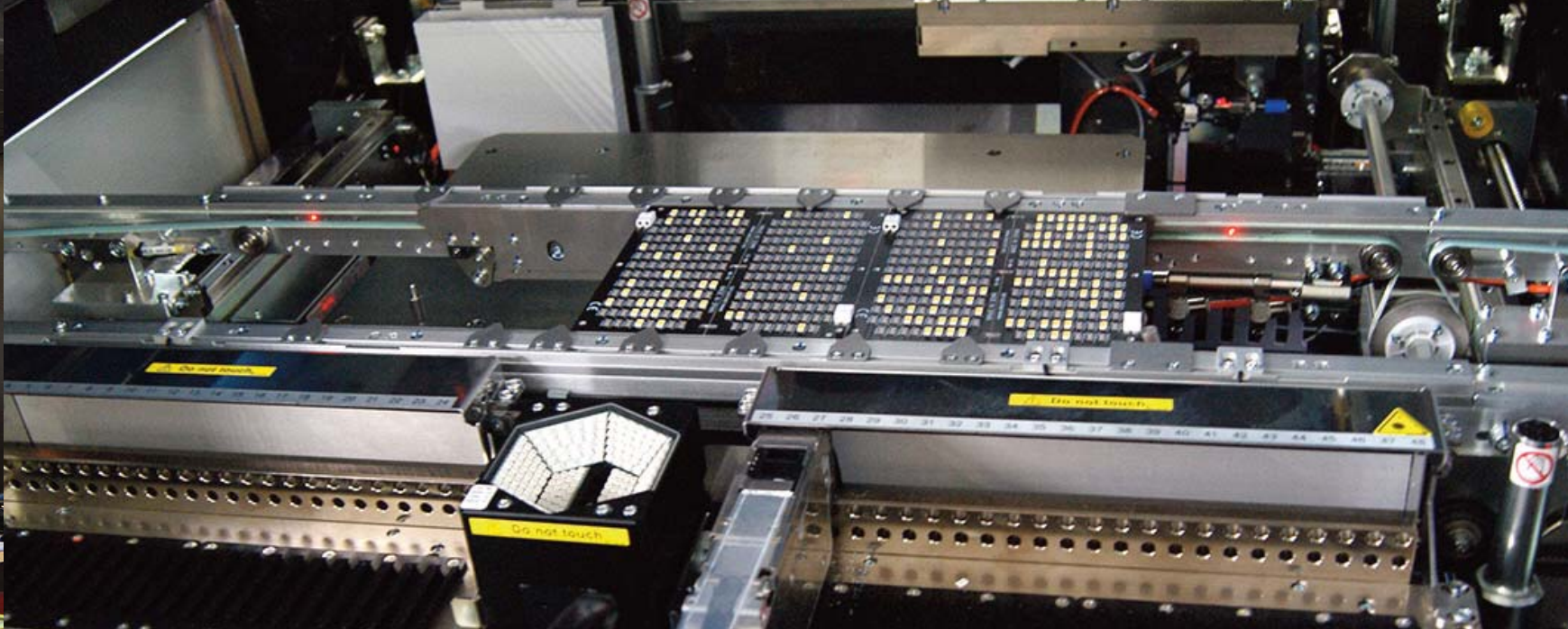

Secom, since September 2010, has a specific space fitted especially for the manufacture of LED.
Secom, depuis Septembre 2010, a une surface spécifique équipée notamment pour la fabrication de LED.

Pick & Place robot and convection reflow oven.
Pick & Place robot et convention four de refusion.



Robotized folding machine. Plieuse robotisée.



Laser cutting equipment for aluminum and other alloys for the manufacture of components.
Laser équipement pour l'aluminium et d'autres alliages de coupe pour la fabrication de composants.

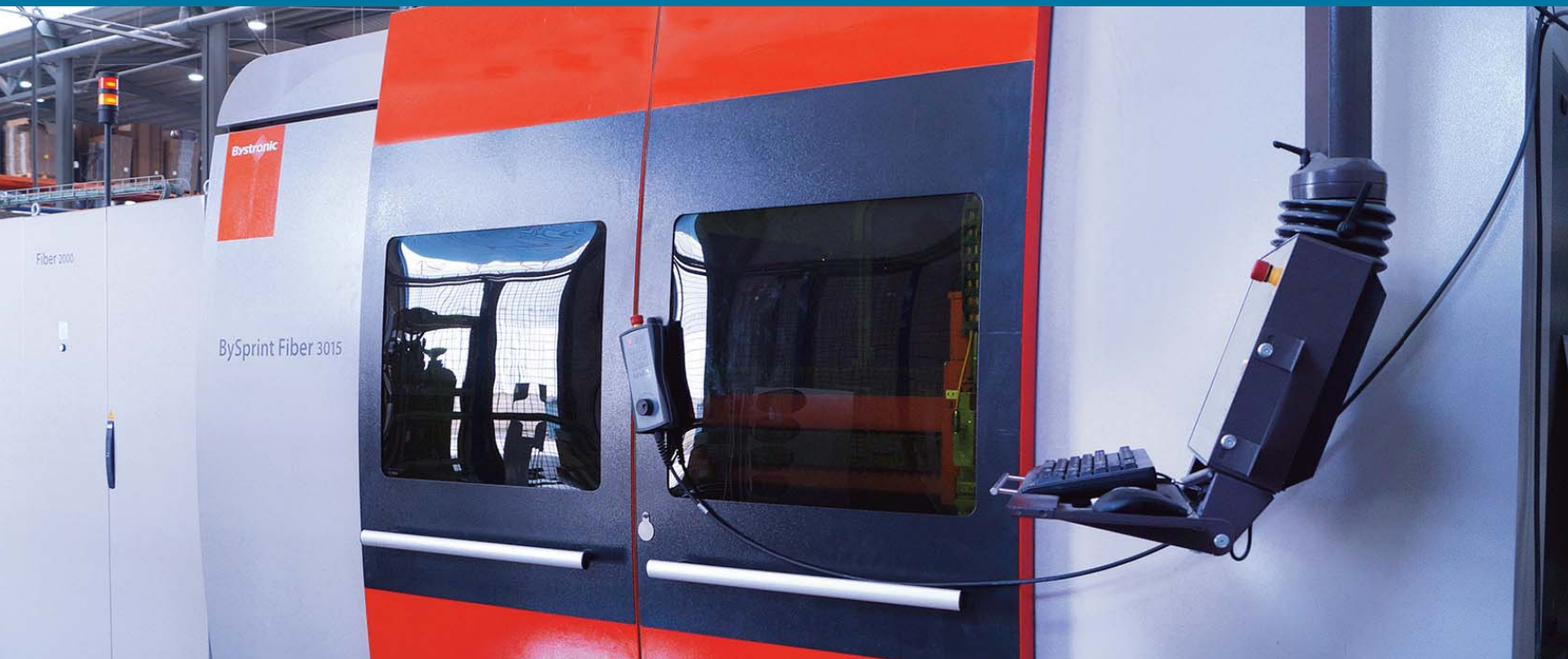

LED Technology

LED word is the acronym of Lighting Emitting Diode.

Secom Iluminacion makes use only of first brands semiconductors in his lighting products, as Osram (Germany), Philips Lumiled (USA), in order to create solutions which allow to develop lighting projects for all needs.

We offer our clients a choice of a wide range of secondary lens, symmetrical, asymmetrical, or with different beam angles depending on their needs and applications, like different uses or activities, lighting effects, atmosphere creation,...

Secom Iluminación designs their products to allow fast and efficient repairs and replacements of any fungible or subject to change components, both during the warranty period and subsequently, enlarging the life of the lamps.

The advantages of lighting with LED technology are:

- Longe life lamps.
- Reduction on maintenance costs.
- No emission neither IR nor UV radiation.
- LED lamps operate at low temperatures (up to -40°C).
- Operation at lower voltage DC.
- High efficient in cold atmospheres.
- Full-life sealing in waterproof lamps.
- Direct lighting increases the system efficiency.
- Robust system; safety against vibrations.
- Lower light scattering to upper hemisphere due to a better optical control.
- Total light regulation without color changes.
- Instantaneous switch-on with 100% light level.
- Install it and forget.

Chromatic reproduction index (CRI or Ra).

We use a scale from 0 to 100 to measure how a luminous source can reproduce the aspect of colours towards a "pattern luminous source". We measure the difference between the colour coming from our luminous source and the real light it would had under normalized light of such a "pattern luminous source".

Colour temperature (Tc)

It is the temperature (Kelvin degrees) reached by a black object when heating up to give out the same light as our luminous source. There is a normalized chart for colours or wavelengths emitted by a black object or "perfect radiator", according to Kelvin degrees. Colour temperature indicates the seeming light of a luminous source, there are 3 major groups:

Warm (yellow light): From 2700°K to 3500°K (around)

Neutral: From 3500°K to 4000°K (around)

Cold (White light): From 4000°K to 6000°K (around)

Colour temperature must match lighting levels to create a natural and nice feeling. Such effect can be checked through a diagram called: "Kruithof chart".

Technologie LED

Mot LED est l'acronyme de l'éclairage à diodes électroluminescentes.

Secom Iluminacion ne utilise que des premières marques semi-conducteurs dans son éclairage produits, comme Osram (Allemagne), Philips Lumiled (USA), afin de créer des solutions qui permettent de développer des projets d'éclairage pour tous les besoins.

Nous offrons à nos clients un choix d'une large gamme de lentille secondaire, symétrique, asymétrique, ou avec différents degrés d'ouverture en fonction de leurs besoins et applications, comme les différents usages ou des activités, des effets d'éclairage, la création d'atmosphère, ...

Secom Iluminación conçoit ses produits pour permettre des réparations rapides et efficaces et remplacements de toute fongibles ou sous réserve de modification des composants, à la fois au cours de la période de garantie et par la suite, l'agrandissement de la vie des lampes.

Les avantages de l'éclairage à technologie LED sont:

- Lampes longue durée de vie.
- Réduction des coûts de maintenance.
- Pas de rayonnement IR, ni émissions ni UV.
- Lampes LED fonctionnent à basses températures (jusqu'à -40°C).
- Fonctionnement à basse tension continu.
- Efficacité High dans des atmosphères froides.
- Full-vie d'étanchéité dans les lampes étanches.
- L'éclairage direct augmente l'efficacité du système.
- Système robuste; la sécurité contre les vibrations.
- Diffusion de la lumière à Basse hémisphère supérieur en raison d'un meilleur contrôle optique.
- Régulation de la lumière totale sans changements de couleur.
- La mise en marche instantanée avec le niveau de lumière de 100%.
- Installez-le et oubliez.

Indice de rendu chromatique (CRI ou Ra).

Nous utilisons une échelle de 0 à 100 pour mesurer la source lumineuse peut reproduire l'aspect de couleurs vers une «source lumineuse de motif». Nous mesurons la différence entre la couleur provenant de la source lumineuse notre et le réel lumière qu'il avait sous la lumière serait normalisée d'un tel "motif lumineux source ».

La température de couleur (Tc)

Ce est la température (en degrés Kelvin) atteint par un objet noir lorsque chauffage jusqu'à donner la même lumière comme source lumineuse. Il est normalisé. Graphique pour les couleurs ou les longueurs d'onde emitted par un objet noir ou «radiateur parfait», selon la température Kelvin degrees. Colour indique la lumière apparente d'une source lumineuse, il ya trois grands groupes:

Chaud (jaune clair): De 2700°K à 3500°K (environ)

Neutre: De 3500°K à 4000°K (environ)

Froide (lumière blanche): De 4000°K à 6000°K (environ)

La température de couleur doit correspondre à des niveaux d'éclairage pour créer un cadre naturel et agréable sentiment. Cet effet peut être vérifié par un diagramme appelé: "Kruithof tableau".

Ref. **DR** Dimmable driver by signal 1-10v.

This system is one of the earliest and simplest systems ever created. Consists in creating a DC voltage that varies between one and ten volts, to control the proportional percentage of the light power, 1 volt to have a power of 10% and 10 volts for 100% power. This system requires passing a cable through the control channel (plus a common return wire). The interference from nearby power cables can affect the signal installation, causing even flicker.

Ref. **DRD** Dimmable driver Dali

It consists of a controller and one or more light fixtures DALI type. This driver ("master") can monitor and manage the light of other devices ("slaves") individually or collectively. To accomplish this goal, to each device is assigned a unique and static address with a numeric range, they should be connected together with just a pair of copper wires for the DALI communication.

Ref. **DRP** Dimmable Driver for Pushbutton

A short press will turn ON or OFF the light. A long press increases or decreases the light intensity. Once you reach the maximum or minimum value will stop automatically. The maximum cable length from the pushbutton to the last driver should be inferior to 15m. In case of exceeding this length, you must ensure the maintenance of the standard supply. The installation of the synchronization cable is required.

Ref. **3420** Connection Cable DRP

Allows the correct synchronization of devices. Connected via plug-in terminals between devices. A master cable controls a maximum of nine slaves.

Ref. **PCFT** Flux control surface

Light sensor device that allows the automatic adjustment to ambient light. Designed to save large amounts of energy compensating excessive levels of lighting. This device is fixed to the ceiling (surface) and is connected to a 1-10v dimmable driver. Where this device is connected it will be considered the "master" driver and depending on the light received by the sensor connected to that driver may regulated a maximum of 10 drivers in the same line. The installation of the synchronization cable is required. Additionally, this sensor has a rotary diaphragm, by which you can manually configure the desired lighting level.

Ref. **CF23** Mini flow control integrated into luminaire

Mini flux control is a light sensor built into the luminaire, which automatically controls the 1-10V dimmable driver to maintain a constant light flow depending on the ambient light. It is designed to save large amounts of energy, compensating excessive levels of lighting. Where it is connected this device will be the "master" driver and depending on the light received by the sensor connected to that driver, it can be regulated in the same line to a maximum of 10 drivers. A synchronization cable would be needed into each slave fixture (Ref. 3420). This sensor has a rotary diagram by which the desired lighting level can be manually set.

Ref. **DM8** Motion detector

LED energy saving automatic system. Motion sensor integrated in the luminaire (placed inside the luminaire alter installation) it turns on the lights when motion is detected (not a presence sensor). Variable detection range from 0,5 to 5 meters, crossing glass and thin materials (except metallic materials). The shutdown time can be configured from 30 seconds to 30 minutes.

Ref. **DR** Dimmable driver signal 1-10v.

Ce système est l'un des systèmes les plus anciens et les plus simples jamais créés. Consiste à la création d'une tension continue qui varie entre une et dix volts, pour commander le pourcentage proportionnel de la puissance lumineuse, 1 volt d'avoir une puissance de 10% et 10 volts pour 100% de la puissance. Ce système nécessite le passage d'un câble par l'intermédiaire du canal de commande (plus un fil de retour commun). L'ingérence des câbles d'alimentation à proximité peuvent affecter l'installation du signal, causant encore scintillement.

Ref. **DRD** Pilote dimmable Dali

Il se compose d'un contrôleur et un ou plusieurs appareils d'éclairage de type DALI. ce pilote ("maître") peut surveiller et gérer la lumière d'autres appareils ("esclaves") individuellement ou collectivement. Pour atteindre cet objectif, à chaque périphérique est assigné une adresse unique et statique avec une plage numérique, ils doit être connecté avec juste une paire de fils de cuivre pour la communication DALI.

Ref. **DRP** Dimmable pilote pour bouton-poussoir

Une pression brève activer ou désactiver la lumière. Une presse augmente ou diminue à long l'intensité lumineuse. Une fois que vous atteignez le maximum ou minimum la valeur se arrête automatiquement. La longueur de câble maximale entre le bouton-poussoir le dernier pilote devrait être inférieure à 15m. En cas de dépassement cette longueur, il faut assurer le maintien de l'offre standard. Le l'installation du câble de synchronisation ne est requise.

Ref. **3420** Câble de connexion DRP

Permet la synchronisation correcte des appareils. Connecté via les bornes de plug-in entre les périphériques. Un câble de maître contrôle un maximum de neuf esclaves.

Ref. **PCFT** Contrôle Flux surface

Dispositif de détection de lumière qui permet le réglage automatique de la lumière ambiante. Conçu pour économiser de grandes quantités d'énergie de compensation des niveaux excessifs de l'éclairage. Ce dispositif est fixé au plafond (surface) et est relié à un Conducteur dimmable 1-10v. Lorsque cet appareil est connecté, il sera considéré comme le "maître" conducteur et en fonction de la lumière reçue par le capteur connecté à ce conducteur peut régulée un maximum de 10 pilotes dans le même ligne. L'installation du câble de synchronisation ne est requise. En outre, ce capteur possède une membrane rotative, par lequel vous pouvez manuellement configurer le niveau d'éclairage souhaitée.

Ref. **CF23** Mini Contrôle de flux intégré dans le luminaire

Mini Contrôle de flux est un capteur de lumière intégré dans le luminaire, qui règle automatiquement le driver réglable 1-10V pour maintenir un flux constant de lumière en fonction de la lumière ambiante. Il est conçu pour économiser de grandes quantités d'énergie, en compensant les niveaux excessifs d'éclairage. Où nous connectons ce dispositif est le driver "maître" et en fonction de la lumière reçue par le capteur connecté à ce driver, nous pourrions régler dans la même ligne un maximum de 10 drivers. Un câble de synchronisation est nécessaire pour chaque appareil esclave (Ref. 3420) Ce capteur a un schéma de rotation par lequel vous pouvez régler manuellement le niveau d'éclairage souhaitée.

Ref. **DM8** Détecteur de mouvement

L'énergie LED sauver système automatique. Détecteur de mouvement intégré dans le luminaire (placé à l'intérieur de l'installation alter luminaire), il allume la lumière lorsqu'un mouvement est détecté (pas de capteur de présence). Plage de détection variable de 0,5 à 5 mètres, en traversant le verre et les matériaux minces (sauf matériaux métalliques). Le temps de shutdown peut être configuré de 30 secondes à 30 minutes.



index

Downlight system LED / **Système de Downlight**

Aircon LED family / **Aircon LED famille**



Aircon LED circular recessed **14**
Aircon LED encastré circulaire

Aircon LED circular surface **15**
Aircon LED circulaire surface

Aircon Supra LED circular **16**
Aircon Supra LED circulaire

Aircon Supra Plus LED circular **17**
Aircon Supra Plus LED circulaire

Aircon Supra LED RGBW circular **18**
Aircon Supra LED RGBW circulaire



Aircon medium LED circular **20**
Aircon medium LED circulaire

Mini Aircom LED circular **21**
Mini Aircom LED circulaire

Aircon Micro LED circular **22**
Aircon Micro LED circulaire

Aircon Micro adjustable LED circular **23**
Aircon Micro orientable LED circulaire

Aircon Micro LED square **24**
Aircon Micro LED carré

Aircon LED square **25**
Aircon LED carré



Mini Aircom LED square **26**
Mini Aircom LED carré

Supra rectangular LED adjustable **28**
Supra rectangulaire LED orientable

Boxter Mini LED

Boxter LED



Boxter Mini LED surface **30**
Boxter Mini LED surface

Boxter Mini LED recessed **31**
Boxter Mini LED encastré

Boxter Mini LED track **32**
Boxter Mini LED rail



Boxter LED surface **34**
Boxter LED surface

Boxter LED recessed **36**
Boxter LED encastré

Boxter LED track **38**
Boxter LED rail

Indoor lighting / Éclairage intérieur

Screen LED / Luminaire plafond LED



Recessed Eslim LED 41
Encastré Eslim LED

Aliket Basic LED



Aliket Basic LED 42
suspension / surface / recessed
suspension / surface / encastré

Aliket LED

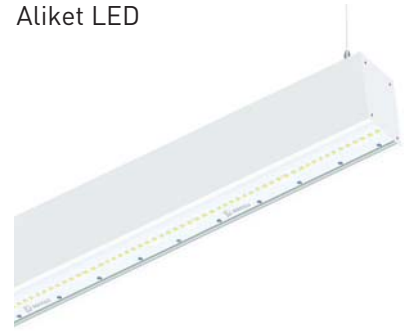

Aliket LED 50

Indoor / Outdoor lighting / Éclairage intérieur / Extérieur

Flood light / Projecteurs



Protek LED 60



Protek Q2 LED 62

Esdium LED



Esdium Sport 66



Esdium Pro LED 74



Esdium Tunnel LED 82



Esdium Industrial LED 86



Esdium RGBW LED 92

Industrial high bay
Suspendu industrielle



Konak LED 96

Waterproof screen LED
Étanche LED



Kloss LED 100



Berna Eco LED 103

Outdoor lighting / Éclairage Extérieur



Flopro Z1 LED 105



Flopro Z2 LED circular / square 106
Flopro Z2 LED circulaire / carré



Flopro Z3 LED circular / square 108
Flopro Z3 LED circulaire / carré



Ceipro C1 LED 111



Ceipro C2 LED circular / square 112
Ceipro C2 LED circulaire / carré



Ceipro C3 LED circular / square 114
Ceipro c3 LED circulaire / carré

Street lighting / Éclairage extérieur / Routière



Protek City LED 116
Protek City LED Duo 118
Protek City LED Trio 119



Protek Q2 City LED 120
Protek Q2 City LED Duo 122
Protek Q2 City LED Trio 123



Ecodut K1 LED 124



Ecodut K2 LED 126



Auris LED 128



Auris LED suspension 129



Kloss City LED 130



LCS Light Control Solution 132



Aircom LED family

Aircom LED family are luminaires that thanks to its elegant design and his 11mm. of thickness, are perfectly integrated in any space, whether commercial or domestic.

High luminous efficiency, Aircom Circular LED, is the result of research and innovation, in Secom Lighting.

The low illuminance of Aircom LED Circular with a low glare index, provides a perfect lighting and a large visual comfort.

Aircom LED Circular is equipped with LED technology Duris E3/E5 Osram which, joined its performance and our distribution system of Light, offers a recessed luminaire destined to any type of surface.

The LED screen slim line is made of cast aluminum coated thermo painted.

Equipped with an innovative optic PMMA which provides a uniform illumination over the entire surface and a high performance lighting. Can be installed on all types of removable roofs, technical ceilings, plaster and plasterboard.

There is the possibility of different finishes, colours and temperatures LED colours, as well as incorporate dimmable drivers and sensors to adapt to performance of CTE.

Aircom LED circular

Protection degree **IP44**

- Material:** Bodies made of aluminium with thermo paint coating.
Optics: Innovative PMMA optic which provides uniform illumination over the whole surface with the minimum thickness of the luminaire.
Supply: All models include control gear and lamps.
Lamps: Modules composed of LEDs Duris E5 with a total power of 15w and 20w.
Estimated life: Estimated life span 50.000 hours.
Installation: For recessed ceiling, adaptable to all kind of modular ceilings and plaster or surface, directly screw on ceiling by screws (not included).
Colours: White, black, gold, chrome, chrome matt, nickel matt and titanium.

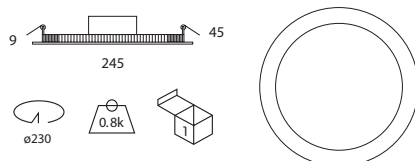

Famille Aircom LED

Famille Aircom LED sont des luminaires qui grâce à sa ligne élégante et son 11mm. d'épaisseur, sont parfaitement intégré dans ne importe quel espace, qu'elle soit commerciale ou domestique.

Haute efficacité lumineuse, Aircom circulaire LED, est le résultat de la recherche et l'innovation, dans l'éclairage Secom.

La faible éclairage de Aircom circulaire LED à faible indice de l'éblouissement, fournit un éclairage parfait et un grand confort visuel.

Aircom circulaire LED est équipé de la technologie LED Osram Duris E3/E5 qui, rejoint sa performance et notre système de distribution de la lumière, offre un luminaire encastré destiné à tout type de surface.

La barre en écran LED est en fonte d'aluminium thermo enduit peint.

Equipé d'un PMMA optique innovant qui fournit un éclairage uniforme sur toute la surface et un éclairage de haute performance. Peut être installé sur tous les types de toits amovibles, plafonds techniques, plâtre et plaque de plâtre.

Il ya la possibilité de finitions différentes, des couleurs et des températures LEDcouleurs, ainsi que les conducteurs à gradation incorporer et capteurs pour se adapter à performance de CTE.

Aircom LED circulaire

Degré de protection **IP44**

- Matériel:** Organismes fous de l'aluminium avec de la peinture thermo revêtement.
Optique: Innovative PMMA optique qui fournit un éclairage uniforme sur la toute la surface avec une épaisseur minimum de l'appareil d'éclairage.
Alimentation: Tous les modèles comprennent les ballasts et les lampes.
Lampes: Modules composés de LED Duris E5 avec une puissance totale de 15W et 20W.
Durée de vie estimée: Durée de vie estimée de spam 50,000 heures.
Installation: Pour encastré au plafond, adaptable à tous les types de plafonds modulaires et en plâtre ou de la surface, vis directement sur le plafond par des vis (non inclus).
Couleurs: Blanc, noir, or, chrome, chrome mat, nickel mat et titane.

Aircom LED circular recessed 15w Aircom LED circulaire encastré 15w



Includes driver and LED lamp / Comprend lampe LED et driver

Ref.	Colour / Couleur	Lúmenes	W	€
4220 01 84	White / Blanc	1740	15w	82,90
4220 02 84	Black / Noir	1740	15w	90,30
4220 03 84	Gold / Or	1740	15w	118,80
4220 05 84	Chrome / Chrome	1740	15w	106,50
4220 52 84	Matt Chrome / Chrome mat	1740	15w	89,90
4220 57 84	Nickel matt / Nickel brossé	1740	15w	109,90
4220 90 84	Titanium / Titane	1740	15w	90,30

* Standardly supplied with 4000° K LED lamp. / En standard fourni avec lampe 4000° K LED.

Aircom LED circular circular recessed 20w Aircom LED circulaire encastré 20w



Includes driver and LED lamp / Comprend lampe LED et driver

Ref.	Colour / Couleur	Lúmenes	W	€
4220 01 20 84	White / Blanc	2677	20w	91,90
4220 02 20 84	Black / Noir	2677	20w	101,60
4220 03 20 84	Gold / Or	2677	20w	131,60
4220 05 20 84	Chrome / Chrome	2677	20w	119,30
4220 52 20 84	Matt Chrome / Chrome mat	2677	20w	101,60
4220 57 20 84	Nickel matt / Nickel brossé	2677	20w	122,60
4220 90 20 84	Titanium / Titane	2677	20w	101,60

* Standardly supplied with 4000° K LED lamp. / En standard fourni avec lampe 4000° K LED.

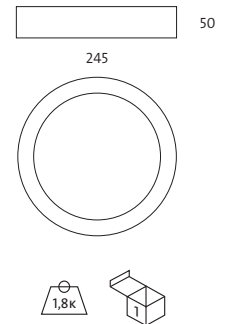

Video Installation
Vidéo d'installation

Aircom LED circular surface 15w Aircom LED circulaire surface 15w



Includes driver and LED lamp / Comprend lampe LED et driver

Ref.	Colour / Couleur	Lúmenes	W	€
4221 01 84	White / Blanc	1740	15w	124,40
4221 02 84	Black / Noir	1740	15w	128,90
4221 52 84	Matt Chrome / Chrome mat	1740	15w	128,90
4221 90 84	Titanium / Titane	1740	15w	128,90

* Standardly supplied with 4000° K LED lamp. / En standard fourni avec lampe 4000° K LED.

Aircom LED circular surface 20w Aircom LED circulaire surface 20w



Includes driver and LED lamp / Comprend lampe LED et driver

Ref.	Colour / Couleur	Lúmenes	W	€
4221 01 20 84	White / Blanc	2677	20w	136,80
4221 02 20 84	Black / Noir	2677	20w	139,52
4221 52 20 84	Matt Chrome / Chrome mat	2677	20w	139,52
4221 90 20 84	Titanium / Titane	2677	20w	139,52

* Standardly supplied with 4000° K LED lamp. / En standard fourni avec lampe 4000° K LED.

Rough price increase of accessories / Accessoires		€
Ref. DRF	Dimmable driver edge phase / Driver réglable par coupure de phase	22,22
Ref. DR	Driver dimmable 1-10V / Driver dimmable 1-10V	47,40
Ref. DRD	Driver dimmable Dali / Driver dimmable Dali	52,90
Ref. DRP	Dimmable driver with push button / Dimmable avec bouton poussoir	62,50
Ref. DM8	Motion detector integrated in the luminaire / Détecteur de mouvement intégré dans le lum.	30,00
Ref. PCFT	Lighting control system for DR / Eclairage système de contrôle pour DR	54,90
Ref. CF23	Mini flux control integrated in the luminaire / Mini contrôle du flux intégré dans le luminaire	44,00
Ref. 3420	Wire connector for DR / Connecteur de fil pour DR	9,60
Ref. 3416	Emergency kit (recessed only) / Trousse d'urgence (encastré seulement)	105,90
Ref. 4160	Driver to power 12 Vdc. / Driver pour alimenter 12 Vdc.	41,90
Ref. 4160 24	Driver to power 24 Vdc. / Driver pour alimenter 24 Vdc.	41,90
Ref. AM	Special marine environment paint / Peinture spéciale pour environnement marin	25,00

OPTIONS LED	Ref. 83	Ref. 84	Ref. 85
CRI>80 / Colour temperature / Température de couleur	3000°K	4000°K	5700°K
Lum 15w	1600	1740	2000
Lum 20w	2600	2677	2677

Aircom Supra LED circular

Protection degree **IP44**

- Material:** Bodies made of aluminium with thermo paint coating.
Optics: Innovative PMMA optic which provides uniform illumination over the whole surface with a minimum thickness of the luminaire.
Supply: All models include control gear and lamps.
Lamps: Modules composed of LEDs Duris E5 with a total power of 20w, 30w, 40w and 60w.
Estimated life: Estimated life span 50.000 hours.
Installation: For recessed ceiling, adaptable to all kind of modular ceilings and plaster.
Colours: White, black, gold, matt gold, chrome, matt chrome, matt nickel, nickel, titanium and satin .

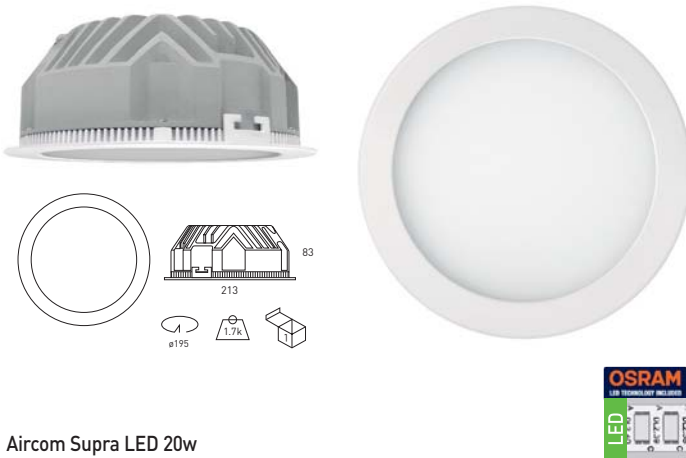

Aircom Supra LED 20w

Includes driver and LED lamp / **Comprend lampe LED et driver**

Ref.	Colour / Couleur	Lumens	W	€
4227 01 20 84	White / Blanc	2677	20w	105,60
4227 02 20 84	Black / Noir	2677	20w	107,40
4227 03 20 84	Gold / Or	2677	20w	131,60
4227 05 20 84	Chrome / Chrome	2677	20w	115,90
4227 33 20 84	Matt Gold / Or mat	2677	20w	107,40
4227 52 20 84	Matt Chrome / Chrome mat	2677	20w	107,40
4227 55 20 84	Nickel / Nickel	2677	20w	107,40
4227 57 20 84	Nickel matt / Nickel brossé	2677	20w	131,60
4227 80 20 84	Satin / Satin	2677	20w	131,60
4227 90 20 84	Titanium / Titane	2677	20w	107,40

* Standardly supplied with 4000° K LED lamp. / En standard fourni avec lampe 4000° K LED.

Aircom Supra LED 30w

Includes driver and LED lamp / **Comprend lampe LED et driver**

Ref.	Colour / Couleur	Lumens	W	€
4227 01 30 84	White / Blanc	3395	30w	158,10
4227 02 30 84	Black / Noir	3395	30w	159,90
4227 03 30 84	Gold / Or	3395	30w	184,10
4227 05 30 84	Chrome / Chrome	3395	30w	168,40
4227 33 30 84	Matt Gold / Or mat	3395	30w	159,90
4227 52 30 84	Matt Chrome / Chrome mat	3395	30w	159,90
4227 55 30 84	Nickel / Nickel	3395	30w	159,90
4227 57 30 84	Nickel matt / Nickel brossé	3395	30w	184,10
4227 80 30 84	Satin / Satin	3395	30w	184,10
4227 90 30 84	Titanium / Titane	3395	30w	159,90

* Standardly supplied with 4000° K LED lamp. / En standard fourni avec lampe 4000° K LED.

OPTIONS LED	Ref. 83	Ref. 84	Ref. 85
CRI>80 / Colour temperature / Température de couleur	3000°K	4000°K	5700°K
Lum 20w	2600	2677	2677
Lum 30w	3370	3395	3395
Lum 40w	5543	5556	5556
Lum 60w	8007	8026	8026

Aircom Supra LED circulaire

Degré de protection **IP44**

- Matériel:** Organismes fous de l'aluminium avec de la peinture thermo revêtement.
Optique: Innovative PMMA optique qui fournit un éclairage uniforme sur la toute la surface avec une épaisseur minimum de l'appareil d'éclairage.
Alimentation: Tous les modèles comprennent les ballasts et les lampes.
Lampes: Modules composés de LED Duris E3 avec une puissance totale de 20w, 30w, 40w et 60w.
Durée de vie estimée: Durée de vie estimée de spam 50.000 heures.
Installation: Pour encastré au plafond, adaptable à tous les types de plafonds modulaires et en plâtre.
Couleurs: Blanc, noir, or, or mat, chrome, chrome mat, nickel brossé, nickelt, titane et satin.

Aircom Supra LED 40w

Includes driver and LED lamp / **Comprend lampe LED et driver**

Ref.	Colour / Couleur	Lumens	W	€
4227 01 40 84	White / Blanc	5556	40w	186,20
4227 02 40 84	Black / Noir	5556	40w	188,40
4227 03 40 84	Gold / Or	5556	40w	212,20
4227 05 40 84	Chrome / Chrome	5556	40w	196,90
4227 33 40 84	Matt Gold / Or mat	5556	40w	188,40
4227 52 40 84	Matt Chrome / Chrome mat	5556	40w	188,40
4227 55 40 84	Nickel / Nickel	5556	40w	188,40
4227 57 40 84	Nickel matt / Nickel brossé	5556	40w	212,20
4227 80 40 84	Satin / Satin	5556	40w	212,20
4227 90 40 84	Titanium / Titane	5556	40w	188,40

* Standardly supplied with 4000° K LED lamp. / En standard fourni avec lampe 4000° K LED.

Aircom Supra LED 60w

Includes driver and LED lamp / **Comprend lampe LED et driver**

Ref.	Colour / Couleur	Lumens	W	€
4227 01 60 84	White / Blanc	8026	60w	199,90
4227 02 60 84	Black / Noir	8026	60w	202,10
4227 03 60 84	Gold / Or	8026	60w	226,80
4227 05 60 84	Chrome / Chrome	8026	60w	210,40
4227 33 60 84	Matt Gold / Or mat	8026	60w	202,10
4227 52 60 84	Matt Chrome / Chrome mat	8026	60w	202,10
4227 55 60 84	Nickel / Nickel	8026	60w	202,10
4227 57 60 84	Nickel matt / Nickel brossé	8026	60w	226,80
4227 80 60 84	Satin / Satin	8026	60w	226,80
4227 90 60 84	Titanium / Titane	8026	60w	202,10

* Standardly supplied with 4000° K LED lamp. / En standard fourni avec lampe 4000° K LED.

Rough price increase of accessories / Accessoires	€
Ref. DRF Dimmable driver edge phase / Driver réglable par coupure de phase	22,22
Ref. IP65 Protection degree IP65 / Degré de protection IP65	15,20
Ref. DR Driver dimmable 1-10V / Driver dimmable 1-10V	47,40
Ref. DRD Driver dimmable Dali / Driver dimmable Dali	52,90
Ref. DM8 Motion detector integrated in the luminaire / Détecteur de mouvement intégré dans le lum.	30,00
Ref. CF23 Mini flux control integrated in the luminaire / Mini contrôle du flux intégré dans le luminaire	44,00
Ref. 3416 Emergency kit (recessed only) / Trousse d'urgence (encastré seulement)	105,90
Ref. 4160 Driver to power 12 Vdc. / Driver pour alimenter 12 Vdc. / 20 / 30 / 40	41,90
Ref. 416024 Driver to power 24 Vdc. / Driver pour alimenter 24 Vdc. / 20 / 30 / 40	41,90
Ref. CRI90 CRI>90 (Only for transparent closing / Seulement pour la fermeture transparente)	20,60
Ref. AM Special marine environment paint / Peinture spéciale pour environnement marin	25,00
Ref. CT Cierre transparente / Fermeture transparente	0,60

Aircom Supra Plus LED circular

Protection degree IP44

- Material:** Bodies made of aluminium with thermo paint coating.
Optics: Innovative PMMA optic which provides uniform illumination over the whole surface with a minimum thickness of the luminaire.
Supply: All models include control gear and lamps.
Lamps: Modules composed of LEDs Oslon SSL with a total power of 60w.
Estimated life: Estimated life span 50.000 hours.
Installation: For recessed ceiling, adaptable to all kind of modular ceilings and plaster.
Colours: White, black, gold, matt gold, chrome, matt chrome, matt nickel, nickel, titanium and satin .



Aircom Supra Plus LED circulaire

Degré de protection IP44

- Matériel:** Organismes fous de l'aluminium avec de la peinture thermo revêtement.
Optique: Innovative PMMA optique qui fournit un éclairage uniforme sur la toute la surface avec une épaisseur minimum de l'appareil d'éclairage.
Alimentation: Tous les modèles comprennent les ballasts et les lampes.
Lampes: Modules composés de LED Oslon SSL avec une puissance totale de 60w.
Durée de vie estimée: Durée de vie estimée de spam 50.000 heures.
Installation: Pour encastré au plafond, adaptable à tous les types de plafonds modulaires et en plâtre.
Couleurs: Blanc, noir, or, or mat, chrome, chrome mat, nickel brossé, nickelt, titane et satin.

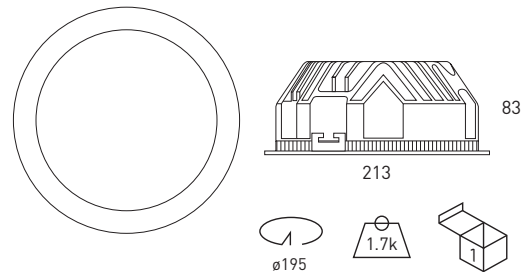

Aircom Supra Plus LED 60w

Includes driver and LED lamp / Comprend lampe LED et driver

Ref.	Colour / Couleur	Lumens	W	€
4227 01 65 84	White / Blanc	7020	60w	208,60
4227 02 65 84	Black / Noir	7020	60w	211,20
4227 03 65 84	Gold / Or	7020	60w	235,40
4227 05 65 84	Chrome / Chrome	7020	60w	219,80
4227 33 65 84	Matt Gold / Or mat	7020	60w	211,20
4227 52 65 84	Matt Chrome / Chrome mat	7020	60w	211,20
4227 55 65 84	Nickel / Nickel	7020	60w	211,20
4227 57 65 84	Nickel matt / Nickel brossé	7020	60w	235,40
4227 80 65 84	Satin / Satin	7020	60w	235,40
4227 90 65 84	Titanium / Titane	7020	60w	211,20

* Standardly supplied with 4000° K LED lamp. / En standard fourni avec lampe 4000° K LED.

OPTIONS LED	Ref. 83	Ref. 84	Ref. 85
CRI>80 / Colour temperature / Température de couleur	3000°K	4000°K	5700°K
Lum 60w	6780	7020	7020

Incremento respecto al driver / Rough price increase of driver	€
Ref. IP65 Protection degree IP65 / Degré de protection IP65	15,20
Ref. DR Driver dimmable 1-10V / Driver dimmable 1-10V	47,40
Ref. DRD Driver dimmable Dali / Driver dimmable Dali	52,90
Ref. DM8 Motion detector integrated in the luminaire / Détecteur de mouvement intégré dans le lum.	30,00
Ref. CF23 Mini flux control integrated in the luminaire / Mini contrôle du flux intégré dans le luminaire	44,00
Ref. 3416 Emergency kit (recessed only) / Trousse d'urgence (encastré seulement)	105,90
Ref. 4160 Driver to power 12 Vdc. / Driver pour alimenter 12 Vdc. / 20 / 30 / 40	41,90
Ref. 416024 Driver to power 24 Vdc. / Driver pour alimenter 24 Vdc. / 20 / 30 / 40	41,90
Ref. CRI90 CRI>90 (Only for transparent closing / Seulement pour la fermeture transparente	20,60
Ref. AM Special marine environment paint / Peinture spéciale pour environnement marin	25,00

Rough price increase of lamp / Incremento rapport à la lampe	60W
Ref. LPF LEDs Fish / Poisson - 4000K - CRI>90	27,00
Ref. LPB LEDs Bread / Pain - 3000K - CRI>90	27,00
Ref. LCM LEDs Meat / Viande - 2700K - CRI>90	27,00
Ref. LVV LEDs Veg. and fruit / Légumes et fruits - 4000K - CRI>90	27,00

Aircom Supra LED RGBW circular

Protection degree IP44

- Material:** Bodies mad of aluminium with thermo paint coating.
Optics: Innovative PMMA optic which provides uniform illumination over the whole surface with a minimum thickness of the luminaire.
Supply: All models include control gear and lamps.
Lamps: Modules composed of LEDs RGBW with a total power of 60w.
Estimated life: Estimated life spam 50.000 hours.
Installation: For recessed ceiling, adaptable to all kind of modular ceilings and plaster.
Colours: White, black, gold, matt gold, chrome, matt chrome, matt nickel, nickel, titanium and satin .



Aircom Supra LED RGBW circulaire

Degré de protection IP44

- Matériel:** Organismes fous de l'aluminium avec de la peinture thermo revêtement.
Optique: Innovative PMMA optique qui fournit un éclairage uniforme sur la toute la surface avec une épaisseur minimum de l'appareil d'éclairage.
Alimentation: Tous les modèles comprennent les ballasts et les lampes.
Lampes: Modules composés de LED RGBW avec une puissance totale de 60w.
Durée de vie estimée: Durée de vie estimée de spam 50.000 heures.
Installation: Pour encastré au plafond, adaptable à tous les types de plafonds modulaires et en plâtre.
Couleurs: Blanc, noir, or, or mat, chrome, chrome mat, nickel brossé, nickelt, titane et satin.

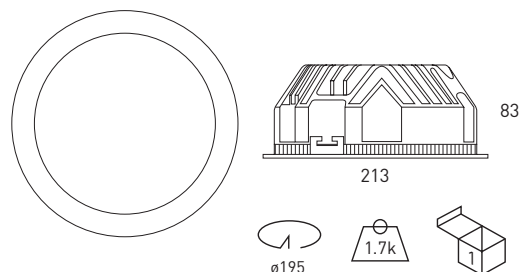

Aircom Supra LED RGBW to controlled Ref. 4500
 Aircom Supra LED RGBW à régulé Réf. 4500



Includes driver and LED lamp / Comprend lampe LED et driver

Ref.	Colour / Couleur	Lamp.	W	€	RAEE lum.
4228 01 60 85 4500	White / Blanc	LED RGBW	60w	466,80	0,10
4228 02 60 85 4500	Black / Noir	LED RGBW	60w	472,28	0,10
4228 03 60 85 4500	Gold / Or	LED RGBW	60w	499,80	0,10
4228 05 60 85 4500	Chrome / Chrome	LED RGBW	60w	479,20	0,10
4228 33 60 85 4500	Matt Gold / Or mat	LED RGBW	60w	472,28	0,10
4228 52 60 85 4500	Matt Chrome / Chrome mat	LED RGBW	60w	472,28	0,10
4228 55 60 85 4500	Nickel / Nickel	LED RGBW	60w	472,28	0,10
4228 57 60 85 4500	Nickel matt / Nickel brossé	LED RGBW	60w	472,28	0,10
4228 80 60 85 4500	Satin / Satin	LED RGBW	60w	499,80	0,10
4228 90 60 85 4500	Titanium / Titane	LED RGBW	60w	472,28	0,10

* Control not included / Contrôle non inclus.

Aircom Supra LED RGBW to controlled Ref. 4501
 Aircom Supra LED RGBW à régulé Réf. 4501



Includes driver and LED lamp / Comprend lampe LED et driver

Ref.	Colour / Couleur	Lamp.	W	€	RAEE lum.
4228 01 60 85 4501	White / Blanc	LED RGBW	60w	479,40	0,10
4228 02 60 85 4501	Black / Noir	LED RGBW	60w	484,60	0,10
4228 03 60 85 4501	Gold / Or	LED RGBW	60w	511,60	0,10
4228 05 60 85 4501	Chrome / Chrome	LED RGBW	60w	484,88	0,10
4228 33 60 85 4501	Matt Gold / Or mat	LED RGBW	60w	484,60	0,10
4228 52 60 85 4501	Matt Chrome / Chrome mat	LED RGBW	60w	484,60	0,10
4228 55 60 85 4501	Nickel / Nickel	LED RGBW	60w	484,60	0,10
4228 57 60 85 4501	Nickel matt / Nickel brossé	LED RGBW	60w	484,60	0,10
4228 80 60 85 4501	Satin / Satin	LED RGBW	60w	511,60	0,10
4228 90 60 85 4501	Titanium / Titane	LED RGBW	60w	484,60	0,10

* Control not included / Contrôle non inclus.

Aircom Supra LED RGBW to controlled Ref. 4502
Aircom Supra LED RGBW à régulé Réf. 4502



Includes driver and LED lamp / Comprend lampe LED et driver

Ref.	Colour / Couleur	Lamp.	W	€	RAEE lum.
4228 01 60 85 4502	White / Blanc	LED RGBW	60w	479,52	0,10
4228 02 60 85 4502	Black / Noir	LED RGBW	60w	484,72	0,10
4228 03 60 85 4502	Gold / Or	LED RGBW	60w	511,72	0,10
4228 05 60 85 4502	Chrome / Chrome	LED RGBW	60w	485,00	0,10
4228 33 60 85 4502	Matt Gold / Or mat	LED RGBW	60w	484,72	0,10
4228 52 60 85 4502	Matt Chrome / Chrome mat	LED RGBW	60w	484,72	0,10
4228 55 60 85 4502	Nickel / Nickel	LED RGBW	60w	484,72	0,10
4228 57 60 85 4502	Nickel matt / Nickel brossé	LED RGBW	60w	484,72	0,10
4228 80 60 85 4502	Satin / Satin	LED RGBW	60w	511,72	0,10
4228 90 60 85 4502	Titanium / Titane	LED RGBW	60w	484,72	0,10

* Control not included / Contrôle non inclus.

RGB LED Downlight for outdoor or indoor facilities, the elegant design allows their adaptability to any environment. Thanks to its high brightness, obtained from LEDs red, green, blue and white colours, this luminaire can be used to decorative lighting in many places. The colour control can be done by several methods:

- Recessed DMX touch screen control powered by a 12V driver, supplied with 230V, the projector is controlled by a wire with DMX signal.
- Recessed radiofrequency touch screen control powered by a 12V driver supplied with 230V, the projector is controlled by wireless.
- Remote radiofrequency touch screen control supplied by 3 batteries, the projector is controlled by wireless.

The equipment required for the signal reception control will be supplied in a waterproof case, external to the projector.

Downlight RGBW LED pour installations intérieures ou extérieures, son design élégant permet l'adaptabilité à tout type d'environnement. Grâce à son excellente luminosité, obtenue à partir de LED rouge, vert, bleu et blanc, permet que ce luminaire puisse être utilisé pour l'éclairage décoratif dans de nombreux endroits. Le contrôle des couleurs peut être fait à partir de plusieurs options:

- Une télécommande tactile encastrée DMX alimenté par un driver 12V et qui doit être alimenté à 230V, nous permet contrôler le projecteur par DMX.
- Une télécommande tactile encastrée radiofréquence alimenté par un driver 12V et qui doit être alimenté à 230V, nous permet contrôler le projecteur par DMX.
- Une télécommande tactile radiofréquence alimenté par 3 batteries, contrôle le projecteur sans fil.

Le matériel nécessaire pour les contrôles de réception de signaux sont fournis dans une boîte étanche, externe au projecteur.



Ref. 4500
RGBW Controller, wall recessed by DMX.
RGBW Controller, mur encastré par DMX.

Ref. 4501
RGBW Controller, wall recessed by radio frequency.
RGBW Controller, mur encastré par radiofréquence.



Ref. 4502
RGBW controller portable wireless by Radio Frequency.
RGBW contrôleur sans fil par Radio Fréquence.



Incremento respecto al driver / Rough price increase of accessories	€
Ref. 4500 RGBW Controller, Wall recessed by DMX RGBW Controller, mur encastré par DMX	335,52
Ref. 4501 RGBW Controller, Wall recessed by Radio Frequency RGBW Controller, mur encastré par radiofréquence	280,90
Ref. 4502 RGBW controller portable wireless by Radio Frequency RGBW contrôleur sans fil par Radio Fréquence	330,00
Ref. IP65 Protection degree IP65 / Degré de protection IP65	15,20

Aircom medium LED circular

Protection degree IP44

- Material:** Bodies made of aluminium with thermo paint coating.
Optics: Innovative PMMA optic which provides uniform illumination over the whole surface with a minimum thickness of the luminaire.
Supply: All models include control gear and lamps.
Lamps: Modules composed of LEDs Duris E5 with a total power of 20w.
Estimated life: Estimated life span 50.000 hours.
Installation: For recessed ceiling, adaptable to all kind of modular ceilings and plaster.
Colours: White, black, gold, chrome, chrome matt, nickel matt and titanium.



Aircom medium LED 20w

Includes driver and LED lamp / [Comprend lampe LED et driver](#)

Ref.	Colour / Couleur	Lumens	W	€
4226 01 84	White / Blanc	2677	20w	75,00
4226 02 84	Black / Noir	2677	20w	79,60
4226 03 84	Gold / Or	2677	20w	106,20
4226 05 84	Chrome / Chrome	2677	20w	106,20
4226 52 84	Matt Chrome / Chrome mat	2677	20w	79,60
4226 57 84	Nickel matt / Nickel brossé	2677	20w	106,20
4226 90 84	Titanium / Titane	2677	20w	79,60

* Standardly supplied with 4000° K LED lamp. / [En standard fourni avec lampe 4000° K LED.](#)

OPTIONS LED	Ref. 83	Ref. 84	Ref. 85
CRI>80 / Colour temperature / Température de couleur	3000°K	4000°K	5700°K
Lum 20w	2600	2677	2677

Aircom Medium LED circulaire

Degré de protection IP44

- Matériel:** Organismes fous de l'aluminium avec de la peinture thermo revêtement.
Optique: Innovative PMMA optique qui fournit un éclairage uniforme sur la toute la surface avec une épaisseur minimum de l'appareil d'éclairage.
Alimentation: Tous les modèles comprennent les ballasts et les lampes.
Lampes: Modules composés de LED Duris E5 avec une puissance totale de 20W.
Durée de vie estimée: Durée de vie estimée de spam 50,000 heures.
Installation: Pour encastré au plafond, adaptable à tous les types de plafonds modulaires et en plâtre.
Couleurs: Blanc, noir, or, chrome, chrome mat, nickel mat et titane.

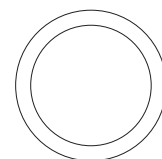
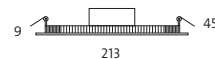

Video Installation
Vidéo d'installation

Rough price increase of accessories / [Accessoires](#)

	€
Ref. DRF Dimmable driver edge phase / Driver réglable par coupure de phase	22,22
Ref. DR Driver dimmable 1-10V / Driver dimmable 1-10V	47,40
Ref. DRD Driver dimmable Dali / Driver dimmable Dali	52,90
Ref. DRP Dimmable driver with push button / Dimmable avec bouton poussoir	62,50
Ref. DM8 Motion detector integrated in the luminaire / Détecteur de mouvement intégré dans le lum.	30,00
Ref. PCFT Lighting control system for DR / Eclairage système de contrôle pour DR	54,90
Ref. CF23 Mini flux control integrated in the luminaire / Mini contrôle du flux intégré dans le luminaire	44,00
Ref. 3420 Wire connector for DR / Connecteur de fil pour DR	9,60
Ref. 3416 Emergency kit (recessed only) / Trousse d'urgence (encastré seulement)	105,90
Ref. 4160 Driver to power 12 Vdc. / Driver pour alimenter 12 Vdc.	41,90
Ref. 4160 24 Driver to power 24 Vdc. / Driver pour alimenter 24 Vdc.	41,90
Ref. AM Special marine environment paint / Peinture spéciale pour environnement marin	23,00

Mini Aircom LED circular

Protection degree IP44

- Material:** Bodies made of aluminium with thermo paint coating.
Optics: Innovative PMMA optic which provides uniform illumination over the whole surface with a minimum thickness of the luminaire.
Supply: All models include control gear and lamps.
Lamps: Modules composed of LEDs Duris E5 with a total power of 9w.
Estimated life: Estimated life span 50.000 hours.
Installation: For recessed ceiling, adaptable to all kind of modular ceilings and plaster or surface, directly screw on ceiling by screws (not included).
Colours: White, black, gold, chrome, chrome matt, nickel matt and titanium.



Mini Aircom LED circulaire

Degré de protection IP44

- Matériel:** Organismes fous de l'aluminium avec de la peinture thermo revêtement.
Optique: Innovative PMMA optique qui fournit un éclairage uniforme sur la toute la surface avec une épaisseur minimum de l'appareil d'éclairage.
Alimentation: Tous les modèles comprennent les ballasts et les lampes.
Lampes: Modules composés de LED Duris E5 avec une puissance totale de 9W.
Durée de vie estimée: Durée de vie estimée de spam 50,000 heures.
Installation: Pour encastré au plafond, adaptable à tous les types de plafonds modulaires et en plâtre ou de la surface, vis directement sur le plafond par des vis (non inclus).
Couleurs: Blanc, noir, or, chrome, chrome mat, nickel mat et titane.

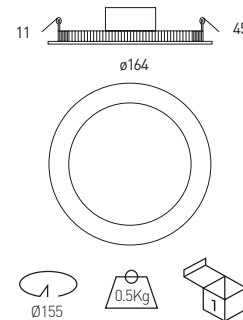

Mini Aircom LED circular 9w Mini Aircom LED circulaire 9w



Includes driver and LED lamp / Comprend lampe LED et driver

Ref.	Colour / Couleur	Lumens	W	€
4206 01 84	White / Blanc	1044	9w	56,70
4206 02 84	Black / Noir	1044	9w	59,90
4206 03 84	Gold / Or	1044	9w	69,90
4206 05 84	Chrome / Chrome	1044	9w	69,90
4206 52 84	Matt Chrome / Chrome mat	1044	9w	62,90
4206 57 84	Nickel matt / Nickel brossé	1044	9w	69,90
4206 90 84	Titanium / Titane	1044	9w	62,90

* Standardly supplied with 4000° K LED lamp. / En standard fourni avec lampe 4000° K LED.

OPTIONS LED	Ref. 83	Ref. 84	Ref. 85
CRI>80 / Colour temperature / Température de couleur	3000°K	4000°K	5700°K
Lum 9w	960	1044	1200



Video Installation
Vidéo d'installation

Rough price increase of accessories / Accessoires		€
Ref. DRF	Dimmable driver edge phase / Driver réglable par coupure de phase	13,90
Ref. DR	Driver dimmable 1-10V / Driver dimmable 1-10V	47,40
Ref. DRD	Driver dimmable Dali / Driver dimmable Dali	52,90
Ref. DRP	Dimmable driver with push button / Dimmable avec bouton poussoir	62,50
Ref. DM8	Motion detector integrated in the luminaire / Détecteur de mouvement intégré dans le lum.	30,00
Ref. PCFT	Lighting control system for DR / Eclairage système de contrôle pour DR	54,90
Ref. CF23	Mini flux control integrated in the luminaire / Mini contrôle du flux intégré dans le luminaire	44,00
Ref. 3420	Wire connector for DR / Connecteur de fil pour DR	9,60
Ref. 3416	Emergency kit (recessed only) / Trousse d'urgence (encastré seulement)	105,90
Ref. 4160	Driver to power 12 Vdc. / Driver pour alimenter 12 Vdc.	41,90
Ref. 4160 24	Driver to power 24 Vdc. / Driver pour alimenter 24 Vdc.	41,90
Ref. AM	Special marine environment paint / Peinture spéciale pour environnement marin	15,00

Aircom Micro LED circular

Protection degree **IP44**

- Material:** Bodies made of aluminium with thermo paint coating.
Optics: Innovative PMMA optic which provides uniform illumination over the whole surface with a minimum thickness of the luminaire.
Supply: All models include control gear and lamps.
Lamps: Modules composed of LEDs Osram Duris E3 with a total power of 5w and 8w.
Estimated life: Estimated life span 50.000 hours.
Installation: For recessed ceiling, adaptable to all kind of modular ceilings and plaster.
Colours: White, black, gold, matt gold, chrome, matt chrome, matt nickel, nickel, titanium and satin .



Aircom Micro LED circular 5w Aircom Micro LED circulaire 5w



Includes driver and LED lamp / Comprend lampe LED et driver

Ref.	Colour / Couleur	Lumens	W	€
4296 05 01 84	White / Blanc	525	5w	23,80
4296 05 02 84	Black / Noir	525	5w	26,80
4296 05 03 84	Gold / Or	525	5w	29,80
4296 05 05 84	Chrome / Chrome	525	5w	29,80
4296 05 33 84	Matt Gold / Or mat	525	5w	29,80
4296 05 52 84	Matt Chrome / Chrome mat	525	5w	26,80
4296 05 55 84	Nickel / Nickel	525	5w	29,80
4296 05 57 84	Nickel matt / Nickel brossé	525	5w	29,80
4296 05 80 84	Santin / Satiné	525	5w	29,80
4296 05 90 84	Titanium / Titane	525	5w	26,80

* Standardly supplied with 4000° K LED lamp. / En standard fourni avec lampe 4000° K LED.

OPTIONS LED	Ref. 83	Ref. 84	Ref. 85
CRI>80 / Colour temperature / Température de couleur	3000°K	4000°K	5700°K
Lum 5w	525	525	525

Rough price increase of accessories / Accessoires		€
Ref. DRF	Dimmable driver edge phase / Driver réglable par coupure de phase	13,90
Ref. DR	Driver dimmable 1-10V / Driver dimmable 1-10V	47,40
Ref. DRD	Driver dimmable Dali / Driver dimmable Dali	52,90
Ref. DM8	Motion detector integrated in the luminaire / Détecteur de mouvement intégré dans le lum.	30,00
Ref. 3416	Emergency kit (recessed only) / Trousse d'urgence (encastré seulement)	105,90
Ref. 4160	Driver to power 12 Vdc. / Driver pour alimenter 12 Vdc.	41,90
Ref. 4160 24	Driver to power 24 Vdc. / Driver pour alimenter 24 Vdc.	41,90
Ref. AM	Special marine environment paint / Peinture spéciale pour environnement marin	15,00

Aircom Micro LED circulaire

Degré de protection **IP44**

- Matériel:** Corps fabriqué en aluminium injecté avec une couverture de peinture au four.
Optique: Nouvelle optique de PMMA qui proportionne un éclairage homogène dans toute sa superficie, avec épaisseur minimum de l'éclairage.
Alimentation: Tous les modèles incluent équipes et lampes adéquats.
Lampes: Modules composés par LEDs Osram Duris E3 avec une puissance totale de 5W et 8W.
Durée de vie estimée: Vie utile moyenne de 50.000 heures.
Installation: Pour encastré au plafond, adaptable à tous les types de plafonds modulaires et en plâtre.
Couleurs: Blanc, noir, doré, doré mat, chrome, chrome mat, nickel, nickel mat, titane et satiné.

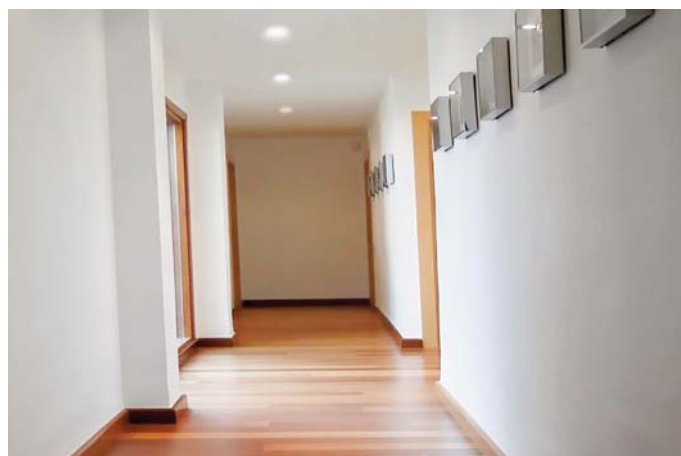

Aircom Micro LED circular 8w Aircom Micro LED circulaire 8w



Includes driver and LED lamp / Comprend lampe LED et driver

Ref.	Colour / Couleur	Lumens	W	€
4296 08 01 84	White / Blanc	920	8w	26,80
4296 08 02 84	Black / Noir	920	8w	28,00
4296 08 03 84	Gold / Or	920	8w	32,50
4296 08 05 84	Chrome / Chrome	920	8w	32,50
4296 08 33 84	Matt Gold / Or mat	920	8w	32,50
4296 08 52 84	Matt Chrome / Chrome mat	920	8w	28,00
4296 08 55 84	Nickel / Nickel	920	8w	32,50
4296 08 57 84	Nickel matt / Nickel brossé	920	8w	32,50
4296 08 80 84	Santin / Satiné	920	8w	32,50
4296 08 90 84	Titanium / Titane	920	8w	28,00

* Standardly supplied with 4000° K LED lamp. / En standard fourni avec lampe 4000° K LED.

OPTIONS LED	Ref. 83	Ref. 84	Ref. 85
CRI>80 / Colour temperature / Température de couleur	3000°K	4000°K	5700°K
Lum 8w	920	920	920

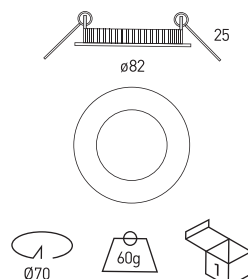

Aircom Micro adjustable LED circular

Protection degree IP44

- Material:** Bodies mad of aluminium with thermo paint coating.
Optics: Innovative PMMA optic which provides uniform illumination over the whole surface with a minimum thickness of the luminaire.
Supply: All models include control gear and lamps.
Lamps: Modules composed of LEDs Duris E3 with a total power of 8w .
Estimated life: Estimated life spam 50.000 hours.
Installation: For recessed ceiling, adaptable to all kind of modular ceilings and plaster.
Colours: White, black, gold, matt gold, chrome, matt chrome, matt nickel, nickel, titanium and satin.



Aircom Micro orientable LED circulaire

Degré de protection IP44

- Matériel:** Organismes fous de l'aluminium avec de la peinture thermo revêtement.
Optique: Innovative PMMA optique qui fournit un éclairage uniforme sur la toute la surface avec une épaisseur minimum de l'appareil d'éclairage.
Alimentation: Tous les modèles comprennent les ballasts et les lampes.
Lampes: Modules composés de LED Duris E3 avec une puissance totale de 8W.
Durée de vie estimée: Durée de vie estimée de spam 50,000 heures.
Installation: Pour encastré au plafond, adaptable à tous les types de plafonds modulaires et en plâtre.
Couleurs: Blanc, noir, or, or mat, chrome, chrome mat, nickel brossé, nickelt, titane et satin.



Aircom Micro LED adjustable 8w Aircom Micro LED réglable 8w



Includes driver and LED lamp / Comprend lampe LED et driver

Ref.	Color / Colour	Lúmenes	W	€
4297 08 01 84	White / Blanc	920	8w	43,30
4297 08 02 84	Black / Noir	920	8w	46,30
4297 08 03 84	Gold / Or	920	8w	51,40
4297 08 05 84	Chrome / Chrome	920	8w	51,40
4297 08 33 84	Matt Gold / Or mat	920	8w	51,40
4297 08 52 84	Matt Chrome / Chrome mat	920	8w	46,30
4297 08 55 84	Nickel / Nickel	920	8w	51,40
4297 08 57 84	Nickel matt / Nickel brossé	920	8w	51,40
4297 08 80 84	Santin / Satiné	920	8w	51,40
4297 08 90 84	Titanium / Titane	920	8w	46,30

* Standardly supplied with 4000° K LED lamp. / En standard fourni avec lampe 4000° K LED.

OPCIONES LED	Ref. 83	Ref. 84	Ref. 85
CRI>80 / Colour temperature / Température de couleur	3000°K	4000°K	5700°K
Lum8w	920	920	920

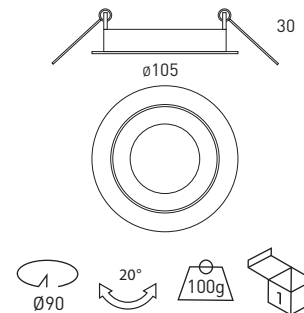

Rough price increase of accessories / Accessoires		€
Ref. DRF	Dimmable driver edge phase / Driver réglable par coupure de phase	13,90
Ref. DR	Driver dimmable 1-10V / Driver dimmable 1-10V	47,40
Ref. DRD	Driver dimmable Dali / Driver dimmable Dali	52,90
Ref. DM8	Motion detector integrated in the luminaire / Détecteur de mouvement intégré dans le lum.	30,00
Ref. 3416	Emergency kit (recessed only) / Trousse d'urgence (encastré seulement)	105,90
Ref. 4160	Driver to power 12 Vdc. / Driver pour alimenter 12 Vdc.	41,90
Ref. 416024	Driver to power 24 Vdc. / Driver pour alimenter 24 Vdc.	41,90
Ref. AM	Special marine environment paint / Peinture spéciale pour environnement marin	15,00

Aircom Micro LED square

Protection degree **IP44**

- Material:** Bodies mad of aluminium with thermo paint coating.
Optics: Innovative PMMA optic which provides uniform illumination over the whole surface with a minimum thickness of the luminaire.
Supply: All models include control gear and lamps.
Lamps: Modules composed of LEDs Duris E3 with a total power of 8w.
Estimated life: Estimated life spam 50.000 hours.
Installation: For recessed ceiling, adaptable to all kind of modular ceilings and plaster.
Colours: White, black, gold, matt gold, chrome, matt chrome, matt nickel, nickel, titanium and satin.

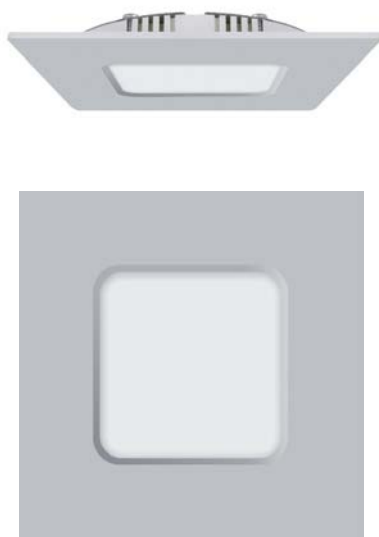

Aircom Micro LED carré

Degré de protection **IP44**

- Matériel:** Organismes fous de l'aluminium avec de la peinture thermo revêtement.
Optique: Innovative PMMA optique qui fournit un éclairage uniforme sur la toute la surface avec une épaisseur minimum de l'appareil d'éclairage.
Alimentation: Tous les modèles comprennent les ballasts et les lampes.
Lampes: Modules composés de LED Duris E3 avec une puissance totale de 8W.
Durée de vie estimée: Durée de vie estimée de spam 50,000 heures.
Installation: Pour encastré au plafond, adaptable à tous les types de plafonds modulaires et en plâtre.
Couleurs: Blanc, noir, or, or mat, chrome, chrome mat, nickel brossé, nickelt, titane et satin.

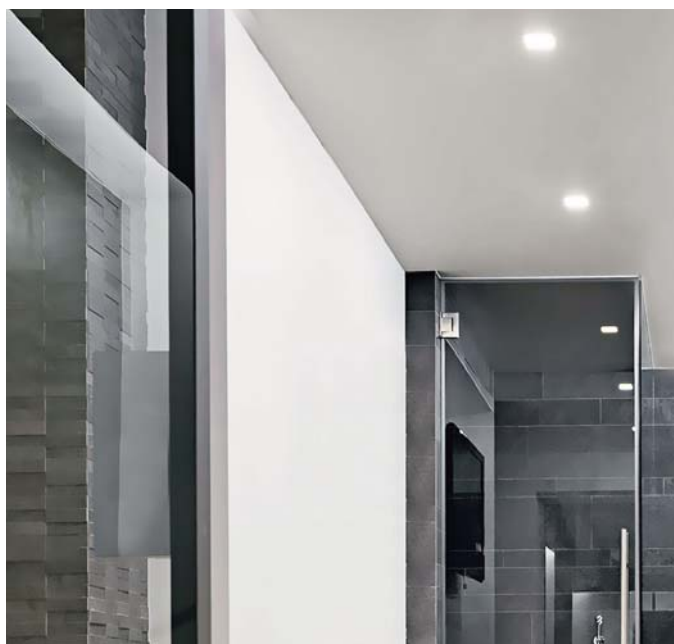

Aircom Micro LED square 8w

Aircom Micro LED carré 8w



Includes driver and LED lamp / Comprend lampe LED et driver

Ref.	Colour / Couleur	Lumens	W	€.
4251 08 01 84	White / Blanc	920	8w	42,20
4251 08 02 84	Black / Noir	920	8w	45,30
4251 08 03 84	Gold / Or	920	8w	50,40
4251 08 05 84	Chrome / Chrome	920	8w	50,40
4251 08 33 84	Matt Gold / Or mat	920	8w	50,40
4251 08 52 84	Matt Chrome / Chrome mat	920	8w	45,30
4251 08 55 84	Nickel / Nickel	920	8w	45,30
4251 08 57 84	Nickel matt / Nickel brossé	920	8w	45,30
4251 08 80 84	Santin / Satiné	920	8w	45,30
4251 08 90 84	Titanium / Titane	920	8w	45,30

* Standardly supplied with 4000° K LED lamp. / En standard fourni avec lampe 4000° K LED.

OPCIONES LED	Ref. 83	Ref. 84	Ref. 85
CRI>80 / Colour temperature / Température de couleur	3000°K	4000°K	5700°K
Lum 8w	920	920	920

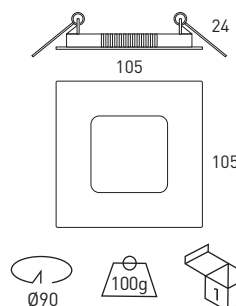

Rough price increase of accessories / Accessoires		€
Ref. DRF	Dimmable driver edge phase / Driver réglable par coupure de phase	13,90
Ref. DR	Driver dimmable 1-10V / Driver dimmable 1-10V	47,40
Ref. DRD	Driver dimmable Dali / Driver dimmable Dali	52,90
Ref. DM8	Motion detector integrated in the luminaire / Détecteur de mouvement intégré dans le lum.	30,00
Ref. 3416	Emergency kit (recessed only) / Trousse d'urgence (encastré seulement)	105,90
Ref. 4160	Driver to power 12 Vdc. / Driver pour alimenter 12 Vdc.	41,90
Ref. 4160 24	Driver to power 24 Vdc. / Driver pour alimenter 24 Vdc.	41,90
Ref. AM	Special marine environment paint / Peinture spéciale pour environnement marin	23,00

Aircom LED square

Protection degree **IP44**

- Material:** Bodies made of aluminium with thermo paint coating.
Optics: Innovative PMMA optic which provides uniform illumination over the whole surface with a minimum thickness of the luminaire.
Supply: All models include control gear and lamps.
Lamps: Modules composed of LEDs Duris E5 with a total power of 20w and 26w.
Estimated life: Estimated life span 50.000 hours.
Installation: For recessed ceiling, adaptable to all kind of modular ceilings and plaster or surface, directly screw on ceiling by screws (not included).
Colours: White, black, gold, chrome, chrome matt, nickel matt and titanium.

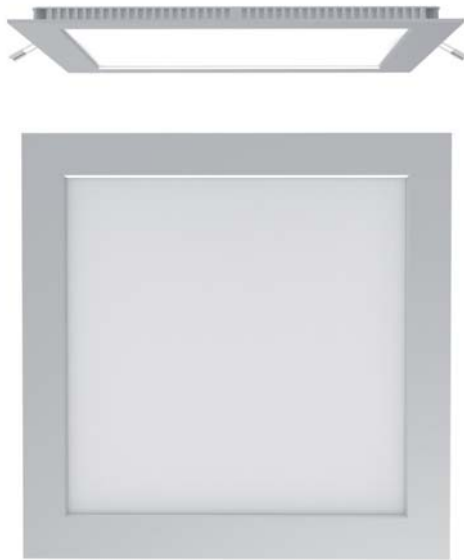

Aircom LED square 20w Aircom LED carré 20w



Includes driver and LED lamp / Comprend lampe LED et driver

Ref.	Colour / Couleur	Lumens	W	€
4223 01 84	White / Blanc	2677	20w	109,60
4223 02 84	Black / Noir	2677	20w	115,60
4223 03 84	Gold / Or	2677	20w	168,80
4223 05 84	Chrome / Chrome	2677	20w	149,80
4223 52 84	Matt Chrome / Chrome mat	2677	20w	115,60
4223 57 84	Nickel matt / Nickel brossé	2677	20w	149,80
4223 90 84	Titanium / Titane	2677	20w	115,60

* Standardly supplied with 4000° K LED lamp. / En standard fourni avec lampe 4000° K LED.

OPTIONS LED	Ref. 83	Ref. 84	Ref. 85
CRI>80 / Colour temperature / Température de couleur	3000°K	4000°K	5700°K
Lum 20w	2600	2677	2677
Lum 26w	3300	3386	3386

Aircom LED carré

Degré de protection **IP44**

- Matériel:** Organismes fous de l'aluminium avec de la peinture thermo revêtement.
Optique: Innovative PMMA optique qui fournit un éclairage uniforme sur la toute la surface avec une épaisseur minimum de l'appareil d'éclairage.
Alimentation: Tous les modèles comprennent les ballasts et les lampes.
Lampes: Modules composés de LED Duris E5 avec une puissance totale de 20W et 26W.
Durée de vie estimée: Durée de vie estimée de spam 50.000 heures.
Installation: Pour encastré au plafond, adaptable à tous les types de plafonds modulaires et en plâtre ou de la surface, vis directement sur le plafond par des vis (non inclus).
Couleurs: Blanc, noir, or, chrome, chrome mat, nickel mat et titane.

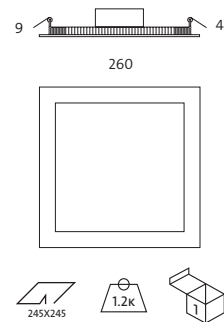

Video Installation
Vidéo d'installation

Aircom LED square 26w Aircom LED carré 26w



Includes driver and LED lamp / Comprend lampe LED et driver

Ref.	Colour / Couleur	Lumens	W	€
4223 26 01 84	White / Blanc	3386	26w	119,60
4223 26 02 84	Black / Noir	3386	26w	126,20
4223 26 03 84	Gold / Or	3386	26w	178,90
4223 26 05 84	Chrome / Chrome	3386	26w	159,10
4223 26 52 84	Matt Chrome / Chrome mat	3386	26w	126,20
4223 26 57 84	Nickel matt / Nickel brossé	3386	26w	168,60
4223 26 90 84	Titanium / Titane	3386	26w	126,20

* Standardly supplied with 4000° K LED lamp. / En standard fourni avec lampe 4000° K LED.

Rough price increase of accessories / Accessoires	€
Ref. DRF Dimmable driver edge phase / Driver réglable par coupure de phase	22,22
Ref. DR Driver dimmable 1-10V / Driver dimmable 1-10V	49,40
Ref. DRD Driver dimmable Dali / Driver dimmable Dali	56,90
Ref. DRP Dimmable driver with push button / Dimmable avec bouton poussoir	66,50
Ref. DM8 Motion detector integrated in the luminaire / Détecteur de mouvement intégré dans le lum.	30,00
Ref. PCFT Lighting control system for DR / Eclairage système de contrôle pour DR	54,90
Ref. CF23 Mini flux control integrated in the luminaire / Mini contrôle du flux intégré dans le luminaire	44,00
Ref. 3420 Wire connector for DR / Connecteur de fil pour DR	9,60
Ref. 3416 Emergency kit (recessed only) / Trousse d'urgence (encastré seulement)	105,90
Ref. 4160 Driver to power 12 Vdc. / Driver pour alimenter 12 Vdc.	41,90
Ref. 416024 Driver to power 24 Vdc. / Driver pour alimenter 24 Vdc.	41,90
Ref. AM Special marine environment paint / Peinture spéciale pour environnement marin	25,00

Mini Aircom LED square

Protection degree **IP44**

- Material:** Bodies made of aluminium with thermo paint coating.
- Optics:** Innovative PMMA optic which provides uniform illumination over the whole surface with a minimum thickness of the luminaire.
- Supply:** All models include control gear and lamps.
- Lamps:** Modules composed of LEDs Duris E3 with a total power of 12w.
- Estimated life:** Estimated life span 50.000 hours.
- Installation:** For recessed ceiling, adaptable to all kind of modular ceilings and plaster or surface, directly screw on ceiling by screws (not included).
- Colours:** White, black, gold, chrome, chrome matt, nickel matt and titanium."



Mini Aircom LED carré

Degré de protection **IP44**

- Matériel:** Organismes fous de l'aluminium avec de la peinture thermo revêtement.
- Optique:** Innovative PMMA optique qui fournit un éclairage uniforme sur la toute la surface avec une épaisseur minimum de l'appareil d'éclairage.
- Alimentation:** Tous les modèles comprennent les ballasts et les lampes.
- Lampes:** Modules composés de LED Duris E3 avec une puissance totale de 12W.
- Durée de vie estimée:** Durée de vie estimée de spam 50,000 heures.
- Installation:** Pour encastré au plafond, adaptable à tous les types de plafonds modulaires et en plâtre ou de la surface, vis directement sur le plafond par des vis (non inclus).
- Couleurs:** Blanc, noir, or, chrome, chrome mat, nickel mat et titane.

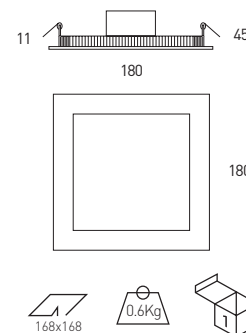

Mini Aircom LED square 13w

Mini Aircom LED carré 13w



Includes driver and LED lamp / Comprend lampe LED et driver

Ref.	Colour / Couleur	Lumens	W	€
4250 01 84	White / Blanc	1281	13w	87,20
4250 02 84	Black / Noir	1281	13w	98,90
4250 03 84	Gold / Or	1281	13w	119,90
4250 05 84	Chrome / Chrome	1281	13w	118,60
4250 52 84	Matt Chrome / Chrome mat	1281	13w	98,90
4250 57 84	Nickel matt / Nickel brossé	1281	13w	119,80
4250 90 84	Titanium / Titane	1281	13w	98,90

* Standardly supplied with 4000° K LED lamp. / En standard fourni avec lampe 4000° K LED.

OPTIONS LED	Ref. 83	Ref. 84	Ref. 85
CRI>80 / Colour temperature / Température de couleur	3000°K	4000°K	5700°K
Lum 13w	1189	1281	1485



Video Installation
Vidéo d'installation

Rough price increase of accessories / Accessoires	€
Ref. DRF Dimmable driver edge phase / Driver réglable par coupure de phase	14,82
Ref. DR Driver dimmable 1-10V / Driver dimmable 1-10V	47,40
Ref. DRD Driver dimmable Dali / Driver dimmable Dali	52,90
Ref. DRP Dimmable driver with push button / Dimmable avec bouton poussoir	62,50
Ref. DM8 Motion detector integrated in the luminaire / Détecteur de mouvement intégré dans le lum.	30,00
Ref. PCFT Lighting control system for DR / Eclairage système de contrôle pour DR	54,90
Ref. CF23 Mini flux control integrated in the luminaire / Mini contrôle du flux intégré dans le luminaire	44,00
Ref. 3420 Wire connector for DR / Connecteur de fil pour DR	9,60
Ref. 3416 Emergency kit (recessed only) / Trousse d'urgence (encastré seulement)	105,90
Ref. 4160 Driver to power 12 Vdc. / Driver pour alimenter 12 Vdc.	41,90
Ref. 416024 Driver to power 24 Vdc. / Driver pour alimenter 24 Vdc.	41,90
Ref. AM Special marine environment paint / Peinture spéciale pour environnement marin	25,00



Supra Rectangular LED adjustable

Protection degree IP44

- Material:** Luminaire made of aluminium with thermo paint coating.
Optics: Innovative PMMA optic which provides uniform illumination over the whole surface with a minimum thickness of the luminaire.
Supply: All models include control gear and lamps.
Lamps: Modules composed of LEDs Osram Oslon SSL with a total power of 40w and 60w.
Estimated life: Estimated life span 50.000 hours.
Installation: For recessed ceiling, adaptable to all kind of modular ceilings and plaster.
Colours: White, black, matt chrome and titanium.



Supra Rectangular LED adjustable 40w Supra Rectangulaire LED orientable 40w



Includes driver and LED lamp / Comprend lampe LED et driver

Ref.	Colour / Couleur	Lumens	W	€
701 01 40 84	White / Blanc	4680	40w	195,40
701 02 40 84	Black / Noir	4680	40w	197,60
701 52 40 84	Matt Chrome / Chrome mat	4680	40w	198,60
701 90 40 84	Titanium / Titane	4680	40w	198,60

* Standardly supplied with 4000° K LED lamp. / En standard fourni avec lampe 4000° K LED.

Supra Rectangular LED adjustable 60w Supra Rectangulaire LED orientable 60w



Includes driver and LED lamp / Comprend lampe LED et driver

Ref.	Colour / Couleur	Lumens	W	€
701 01 60 84	White / Blanc	6760	60w	209,90
701 02 60 84	Black / Noir	6760	60w	211,40
701 52 60 84	Matt Chrome / Chrome mat	6760	60w	212,60
701 90 60 84	Titanium / Titane	6760	60w	212,60

* Standardly supplied with 4000° K LED lamp. / En standard fourni avec lampe 4000° K LED.

Supra Rectangulaire LED orientable

Degré de protection IP44

- Matériel:** Organismes fous de l'aluminium avec de la peinture thermo revêtement.
Optique: Innovative PMMA optique qui fournit un éclairage uniforme sur la toute la surface avec une épaisseur minimum de l'appareil d'éclairage. Tous les modèles comprennent les ballasts et les lampes.
Alimentation: Modules composés de LED Osram SSL avec une puissance totale de 60w.
Lampes: Modules composés de LED Osram SSL avec une puissance totale de 60w.
Durée de vie estimée: Durée de vie estimée de spam 50.000 heures.
Installation: Pour encastré au plafond, adaptable à tous les types de plafonds modulaires et en plâtre.
Couleurs: Blanc, noir, chrome mat et titane.

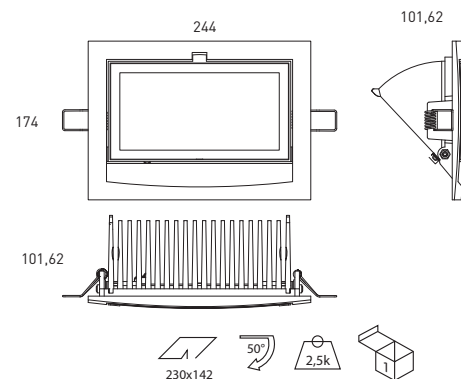

Rough price increase of accessories / Accessoires		€
Ref. DR	Driver dimmable 1-10V / Driver dimmable 1-10V	47,40
Ref. DRD	Driver dimmable Dali / Driver dimmable Dali	52,90
Ref. DM8	Motion detector integrated in the luminaire / Détecteur de mouvement intégré dans le lum.	30,00
Ref. 3416	Emergency kit (recessed only) / Trousse d'urgence (encastré seulement)	105,90
Ref. 3421	Symmetric 150° / Symétrique 150°	3,00
Ref. CRI90	CRI>90 (Only for transparent closing / Seulement pour la fermeture transparente)	20,60
Ref. AM	Special marine environment paint / Peinture spéciale pour environnement marin	25,00
Ref. CM	Matt closing / Fermeture mat	0,60

Rough price increase of lamp / Incremento rapport à la lampe		40W	60W
Ref. LPF	LEDs Fish / Poisson - 4000K - CRI>90	26,00	27,00
Ref. LPB	LEDs Bread / Pain - 3000K - CRI>90	26,00	27,00
Ref. LCM	LEDs Meat / Viande - 2700K - CRI>90	26,00	27,00
Ref. LVV	LEDs Veg. and fruit / Légumes et fruits - 4000K - CRI>90	26,00	27,00

OPTIONS LED	Ref. 83	Ref. 84	Ref. 85
CRI>80 / Colour temperature / Température de couleur	3000°K	4000°K	5700°K
Lum 40w	4520	4680	4680
Lum 60w	6530	6760	6760



Deeigual

Caer está permitido. Levantarse es obligatorio!

Proyecto Base

Boxter Mini surface

Protection degree IP20

- Material:** Injected aluminium and thermo painted steel.
Optics: Optics incorporated in the lamps with different open angles. 12° / 38° / 54°.
Supply: All models include control gear and lamps.
Lamps: Osram LED modules composed Luxeon M Philips Lumiled with 9w power. Ra(CRI)>80 with option of >90 and available in three colour temperatures: 3000°K, 4000°K and 5000°K.
Life span: Estimated average life span 50.000 hours.
Installation: Directly screw on ceiling by screws (not included).
Colours: White, black, matt chrome and titanium.

Boxter Mini surface

Degré de protection IP20

- Matériel:** Aluminium injecté et thermo acier peint.
Optique: Optique incorporés dans les lampes avec différents angles ouverts. 12° / 38° / 54°.
Alimentation: Tous les modèles incluent ballasts et des lampes.
Lampes: Modules LED Osram composées SSL Oslon Osram avec 9W de puissance. Ra (CRI)>80 avec option de >90 et disponible en trois couleurs températures: 3000°K, 4000°K et 5000°K.
Durée de vie estimée: Durée de vie moyenne de 50.000 heures estimée.
Installation: Vis directement sur le plafond par des vis (non inclus).
Couleurs: Blanc, noir, chrome mat et le titane.



Boxter surface 9w Boxter surface 9w



Includes driver and LED lamp
Comprend lampe LED et driver

Ref.	Colour / Couleur	Lum.	W	€
5005 01 9 84	White / Blanc	905	9w	169,82
5005 02 9 84	Black / Noir	905	9w	174,12
5005 52 9 84	Matt Chrome / Chrome mat	905	9w	174,12
5005 90 9 84	Titanium / Titane	905	9w	174,12

* Standardly supplied with maximum lamp opening angle (38°).

* En standard fourni avec angle d'ouverture de la lampe maximum (38°).

* Standardly supplied with 4000° K LED lamp.

* En standard fourni avec lampe 4000° K LED.

OPTIONS LED	Ref. 83	Ref. 84	Ref. 85	
CRI>80 / Colour temp./ Temp. de couleur	W	3000°K	4000°K	5000°K
Luxeon M Philips Lumiled	9w	800	905	905

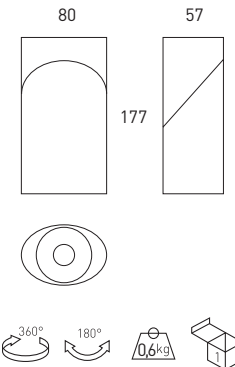

Rough price increase of driver / Accessoires

Ref.	€
Ref. C54 Matt lock diffuser 54° opening angle / Diffuseur matt angle d'ouverture de 54°	3,00
Ref. 12 Opening angle 12° / Angle d'ouverture 12°	5,60
Ref. CRI 90 CRI>90	20,60

Boxter Mini recessed

Protection degree IP20

- Material:** Injected aluminium and thermo painted steel.
Optics: Optics incorporated in the lamps with different open angles. 12° / 38° / 54°.
Supply: All models include control gear and lamps.
Lamps: Osram LED modules composed Luxeon M Philips Lumiled with 9w power. Ra(CRI)>80 with option of >90 and available in three colour temperatures: 3000°K, 4000°K and 5000°K.
Life span: Estimated average life span 50.000 hours.
Installation: Recessed false ceilings, adaptable to all kinds of modular and smooth plaster ceilings.
Colours: White, black, matt chrome and titanium.

Boxter Mini encastré

Degré de protection IP20

- Matériel:** Aluminium injecté et thermo acier peint.
Optique: Optique incorporés dans les lampes avec différents angles ouverts. 12° / 38° / 54°.
Alimentation: Tous les modèles incluent ballasts et des lampes.
Lampes: Modules LED Osram composées SSL Oslon Osram avec 9W de puissance. Ra (CRI)>80 avec option de >90 et disponible en trois couleurs températures : 3000°K, 4000°K et 5000°K.
Durée de vie estimée: Durée de vie moyenne de 50.000 heures estimée.
Installation: Encastré pour faux-plafonds, adaptable à toutes sortes de modulaires et lisses plafonds en plâtre.
Couleurs: Blanc, noir, chrome mat et le titane.



Boxter recessed 9w Boxter encastré 9w



Includes driver and LED lamp
Comprend lampe LED et driver

Ref.	Colour / Couleur	Lum.	W	€
5006 01 9 84	White / Blanc	905	9w	198,20
5006 02 9 84	Black / Noir	905	9w	199,84
5006 52 9 84	Matt Chrome / Chrome mat	905	9w	199,84
5006 90 9 84	Titanium / Titane	905	9w	199,84

* Standardly supplied with maximum lamp opening angle (38°).

* En standard fourni avec angle d'ouverture de la lampe maximum (38°).

* Standardly supplied with 4000° K LED lamp.

* En standard fourni avec lampe 4000° K LED.

OPTIONS LED		Ref. 83	Ref. 84	Ref. 85
CRi>80 / Colour temp./ Temp. de couleur	W	3000°K	4000°K	5000°K
Luxeon M Philips Lumiled	9w	800	905	905

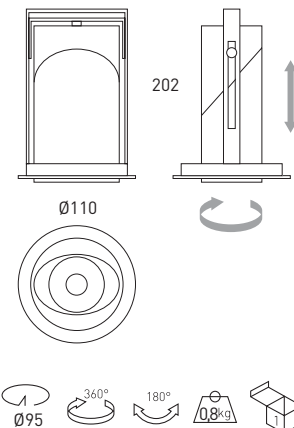

Rough price increase of driver / Accessoires	€
Ref. C54 Matt lock diffuser 54° opening angle / Diffuseur matt angle d'ouverture de 54°	3,00
Ref. 12 Opening angle 12° / Angle d'ouverture 12°	5,60
Ref. CRI 90 CRI>90	20,60

Boxter Mini track

Protection degree IP20

Material:	Injected aluminium and thermo painted steel.
Óptica:	Optics incorporated in the lamps with different open angles. 12° / 38° / 54°.
Alimentación:	All models include control gear and lamps.
Lámparas:	Osram LED modules composed Luxeon M Philips Lumiled with 9w power. Ra(CRI)>80 with option of >90 and available in three colour temperatures: 3000°K, 4000°K and 5000°K.
Vida útil:	Estimated average life span 50.000 hours.
Instalación:	Directly on electrified track 220v.
Colores:	White, black, matt chrome and titanium.

Boxter Mini rail

Degré de protection IP20

Matériel:	Aluminium injecté et thermo acier peint.
Optique:	Optique incorporés dans les lampes avec différents angles ouverts. 12° / 38° / 54°.
Alimentation:	Tous les modèles incluent ballasts et des lampes.
Lampes:	Modules LED Osram composées SSL Osram avec 9W de puissance. Ra (CRI) > 80 avec option de >90 et disponible en trois couleurs températures: 3000°K, 4000°K et 5000°K.
Durée de vie estimée:	Durée de vie moyenne de 50.000 heures estimée.
Installation:	Directement sur la piste électrifiée 220v.
Couleurs:	Blanc, noir, chrome mat et le titane.



Boxter track 9w Boxter rail 9w



Includes driver and LED lamp
Comprend lampe LED et driver

Ref.	Colour / Couleur	Lum.	W	€
5007 01 9 84	White / Blanc	905	9w	174,32
5007 02 9 84	Black / Noir	905	9w	178,64
5007 52 9 84	Matt Chrome / Chrome mat	905	9w	178,64
5007 90 9 84	Titanium / Titane	905	9w	178,64

* Standardly supplied with maximum lamp opening angle (38°).

* En standard fourni avec angle d'ouverture de la lampe maximum (38°).

* Standardly supplied with 4000° K LED lamp.

* En standard fourni avec lampe 4000° K LED.

OPTIONS LED	Ref. 83	Ref. 84	Ref. 85	
CRI>80 / Colour temp./ Temp. de couleur	W	3000°K	4000°K	5000°K
Luxeon M Philips Lumiled	9w	800	905	905

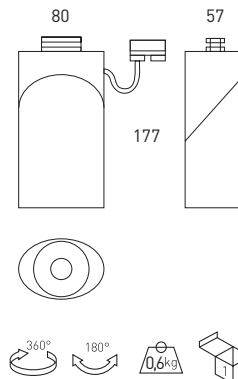

Rough price increase of driver / Accessoires	€
Ref. C54 Matt lock diffuser 54° opening angle / Diffuseur matt angle d'ouverture de 54°	3,00
Ref. 12 Opening angle 12° / Angle d'ouverture 12°	5,60
Ref. CRI 90 CRI>90	20,60



Estrografía de la cueva

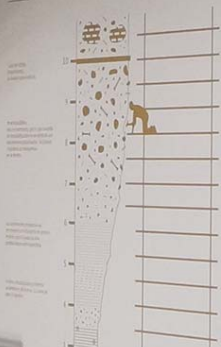

Cueva Pintada es única por presentar...
La zona de estudio...
El yacimiento...
El yacimiento...



Boxter surface

Protection degree IP20

Material:	Injected aluminium and thermo painted steel.
Optics:	Optics incorporated in the lamps with different open angles. 16°/28°/54°.
Supply:	All models include control gear and lamps.
Lamps:	Osram LED modules composed Osram Oslon SSL with 13/26/31w power. Ra(CRI)>80 and available in three colour temperatures: 3000°K, 4000°K and 5000°K.
Life span:	Estimated average life span 50.000 hours.
Installation:	Directly screw on ceiling by screws (not included).
Colours:	White, black, matt chrome and titanium.

Boxter surface

Degré de protection IP20

Matériel:	Aluminium injecté et thermo acier peint.
Optique:	Optique incorporés dans les lampes avec différents angles ouverts. 16° / 28° / 54°.
Alimentation:	Tous les modèles incluent ballasts et des lampes.
Lampes:	Modules LED Osram composées SSL Oslon Osram avec 13/26 / 31W de puissance. Ra (CRI) > 80 et disponible en trois couleurs températures: 3000°K, 4000°K et 5000°K.
Durée de vie estimée:	Durée de vie moyenne de 50.000 heures estimée.
Installation:	Vis directement sur le plafond par des vis (non inclus).
Couleurs:	Blanc, noir, chrome mat et le titane.



Boxter surface 13w Boxter surface 13w



Includes driver and LED lamp / Comprend lampe LED et driver

Ref.	Colour / Couleur	Lumens	W	€
5001 01 13 84	White / Blanc	1522	13w	189,80
5001 02 13 84	Black / Noir	1522	13w	194,10
5001 52 13 84	Matt Chrome / Chrome mat	1522	13w	194,10
5001 90 13 84	Titanium / Titane	1522	13w	194,10

* Standardly supplied with maximum lamp opening angle (54°).

* En standard fourni avec angle d'ouverture de la lampe maximum (54°).

* Standardly supplied with 4000° K LED lamp.

* En standard fourni avec lampe 4000° K LED.

Rough price increase of driver / Accessoires		€
Ref. DR13	Driver dimmable 1-10V / Driver Dimmable 1-10V	29,90
Ref. DRD13	Driver dimmable Dali / Driver dimmable Dali	32,60

Boxter surface 26w Boxter surface 26w



Includes driver and LED lamp / Comprend lampe LED et driver

Ref.	Colour / Couleur	Lumens	W	€
5001 01 26 84	White / Blanc	3045	26w	199,90
5001 02 26 84	Black / Noir	3045	26w	204,60
5001 52 26 84	Matt Chrome / Chrome mat	3045	26w	204,60
5001 90 26 84	Titanium / Titane	3045	26w	204,60

* Standardly supplied with maximum lamp opening angle (54°).

* En standard fourni avec angle d'ouverture de la lampe maximum (54°).

* Standardly supplied with 4000° K LED lamp.

* En standard fourni avec lampe 4000° K LED.

Rough price increase of driver / Accessoires		€
Ref. DR26	Driver dimmable 1-10V / Driver Dimmable 1-10V	69,90
Ref. DRD26	Driver dimmable Dali / Driver dimmable Dali	72,50

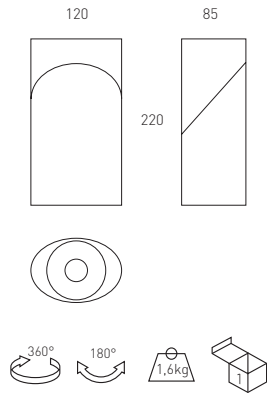

Boxter surface 31w
Boxter surface 31w



Includes driver and LED lamp / Comprend lampe LED et driver

Ref.	Colour / Couleur	Lumens	W	€
5001 01 31 84	White / Blanc	4060	31w	218,50
5001 02 31 84	Black / Noir	4060	31w	223,20
5001 52 31 84	Matt Chrome / Chrome mat	4060	31w	223,20
5001 90 31 84	Titanium / Titane	4060	31w	223,20

- * Standardly supplied with maximum lamp opening angle [54°].
- * En standard fourni avec angle d'ouverture de la lampe maximum [54°].
- * Standardly supplied with 4000° K LED lamp.
- * En standard fourni avec lampe 4000° K LED.

Rough price increase of driver / Accessoires			€
Ref. DR31	Driver dimmable 1-10V / Driver Dimmable 1-10V		75,60
Ref. DRD31	Driver dimmable Dali / Driver dimmable Dali		77,20

Rough price increase of lamp / Accesories		€
Ref. CRI90	CRI > 90	20,60
Ref. 16	Opening angle 16° / Angle d'ouverture 16°	5,60
Ref. 28	Opening angle 28° / Angle d'ouverture 28°	5,80
Ref. 3410	Cover reflector Boxter / Couverture réflecteur Boxter	5,80



Rough price increase of lamp / Icremento rapport à la lampe		13w	26W	31W
Ref. LPF	LEDs Fish / Poisson - 4000K - CRI>90	12,00	18,00	19,00
Ref. LPB	LEDs Bread / Pain - 3000K - CRI>90	12,00	18,00	19,00
Ref. LCM	LEDs Meat / Viande - 2700K - CRI>90	12,00	18,00	19,00
Ref. LVV	LEDs Veg. and fruit / Légumes et fruits - 4000K - CRI>90	12,00	18,00	19,00

OPTIONS LED		Ref. 83	Ref. 84	Ref. 85
CRI>80 / Colour temp./ Temp. de couleur	W	3000°K	4000°K	5000°K
Osram Oslon SSL	13w	1470	1522	1575
	26w	2940	3045	3150
	31w	3920	4060	4200

Boxter recessed

Grado de protección IP20

- Material:** Injected aluminium and thermo painted steel.
- Optics:** Optics incorporated in the lamps with different open angles. 16°/28°/54°.
- Supply:** All models include control gear and lamps.
- Lamps:** Osram LED modules composed Osram Oslon SSL with 13/26/31w power. Ra(CRI)>80 and available in three colour temperatures: 3000°K, 4000°K and 5000°K.
- Life span:** Estimated average life span 50.000 hours.
- Installation:** Recessed for false ceilings, adaptable to all kinds of modular and smooth plaster ceilings.
- Colours:** White, black, matt chrome and titanium.



Boxter encastré

Degré de protection IP20

- Matériel:** Aluminium injecté et thermo acier peint.
- Optique:** Optique incorporés dans les lampes avec différents angles ouverts. 16° / 28° / 54°.
- Alimentation:** Tous les modèles incluent ballasts et des lampes.
- Lampes:** Modules LED Osram composées SSL Oslon Osram avec 13/26 / 31W de puissance. Ra (CRI)> 80 et disponible en trois couleurs températures : 3000°K, 4000°K et 5000°K.
- Durée de vie estimée:** Durée de vie moyenne de 50.000 heures estimée.
- Installation:** Encastré pour faux-plafonds, adaptable à toutes sortes de modulaires et lisses plafonds en plâtre.
- Couleurs:** Blanc, noir, chrome mat et le titane.



Boxter recessed 13w Boxter encastré 13w



Includes driver and LED lamp / Comprend lampe LED et driver

Ref.	Colour / Couleur	Lumens	W	€
5002 01 13 84	White / Blanc	1522	13w	225,20
5002 02 13 84	Black / Noir	1522	13w	229,60
5002 52 13 84	Matt Chrome / Chrome mat	1522	13w	229,60
5002 90 13 84	Titanium / Titane	1522	13w	229,60

* Standardly supplied with maximum lamp opening angle [54°].

* En standard fourni avec angle d'ouverture de la lampe maximum [54°].

* Standardly supplied with 4000° K LED lamp.

* En standard fourni avec lampe 4000° K LED.

Rough price increase of driver / Accessoires		€
Ref. DR13	Driver dimmable 1-10V / Driver Dimmable 1-10V	29,90
Ref. DRD13	Driver dimmable Dali / Driver dimmable Dali	32,60

Boxter recessed 26w Boxter encastré 26w



Includes driver and LED lamp / Comprend lampe LED et driver

Ref.	Colour / Couleur	Lumens	W	€
5002 01 26 84	White / Blanc	3045	26w	235,40
5002 02 26 84	Black / Noir	3045	26w	239,60
5002 52 26 84	Matt Chrome / Chrome mat	3045	26w	239,60
5002 90 26 84	Titanium / Titane	3045	26w	239,60

* Standardly supplied with maximum lamp opening angle [54°].

* En standard fourni avec angle d'ouverture de la lampe maximum [54°].

* Standardly supplied with 4000° K LED lamp.

* En standard fourni avec lampe 4000° K LED.

Rough price increase of driver / Accessoires		€
Ref. DR26	Driver dimmable 1-10V / Driver Dimmable 1-10V	69,90
Ref. DRD26	Driver dimmable Dali / Driver dimmable Dali	72,50

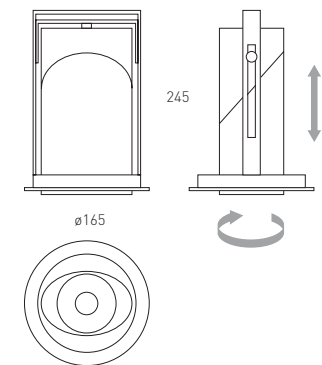

Boxter recessed 31w
Boxter encastré 31w



Includes driver and LED lamp / Comprend lampe LED et driver

Ref.	Colour / Couleur	Lumens	W	€
5002 01 31 84	White / Blanc	4060	31w	254,80
5002 02 31 84	Black / Noir	4060	31w	259,10
5002 52 31 84	Matt Chrome / Chrome mat	4060	31w	259,10
5002 90 31 84	Titanium / Titane	4060	31w	259,10

* Standardly supplied with maximum lamp opening angle (54°).

* En standard fourni avec angle d'ouverture de la lampe maximum (54°).

* Standardly supplied with 4000° K LED lamp.

* En standard fourni avec lampe 4000° K LED.

Rough price increase of driver / Accessoires		€
Ref. DR31	Driver dimmable 1-10V / Driver Dimmable 1-10V	75,60
Ref. DRD31	Driver dimmable Dali / Driver dimmable Dali	77,20

Rough price increase of lamp / Accessoires

Ref.	Description	€
Ref. CR190	CRI > 90	20,60
Ref. 16	Opening angle 16° / Angle d'ouverture 16°	5,60
Ref. 28	Opening angle 28° / Angle d'ouverture 28°	5,80
Ref. 3410	Cover reflector Boxter / Couverture réflecteur Boxter	5,80

Rough price increase of lamp / Incremento rapport à la lampe

Ref.	Description	13w	26W	31W
Ref. LPF	LEDs Fish / Poisson - 4000K - CRI>90	12,00	18,00	19,00
Ref. LPB	LEDs Bread / Pain - 3000K - CRI>90	12,00	18,00	19,00
Ref. LCM	LEDs Meat / Viande - 2700K - CRI>90	12,00	18,00	19,00
Ref. LVV	LEDs Veg. and fruit / Légumes et fruits - 4000K - CRI>90	12,00	18,00	19,00

OPTIONS LED

CRI>80 / Colour temp./ Temp. de couleur	W	Ref. 83 3000°K	Ref. 84 4000°K	Ref. 85 5000°K
Osram Oslon SSL	13w	1470	1522	1575
	26w	2940	3045	3150
	31w	3920	4060	4200

Boxter track

Protection degree IP20

Material:	Injected aluminium and thermo painted steel.
Optics:	Optics incorporated in the lamps with different open angles. 16°/28°/54°.
Supply:	All models include control gear and lamps.
Lamps:	Osram LED modules composed Osram Oslon SSL with 13/26/31w power. Ra(CRI)>80 and available in three colour temperatures: 3000°K, 4000°K and 5000°K.
Life span:	Estimated average life span 50.000 hours.
Installation:	Directly on electrified track 220v.
Colours:	White, black, matt chrome and titanium.

Boxter rail

Degré de protection IP20

Matériel:	Aluminium injecté et thermo acier peint.
Optique:	Optique incorporés dans les lampes avec différents angles ouverts. 16° / 28° / 54°.
Alimentation:	Tous les modèles incluent ballasts et des lampes.
Lampes:	Modules LED Osram composées SSL Oslon Osram avec 13/26 / 31W de puissance. Ra (CRI) > 80 et disponible en trois couleurs températures: 3000°K, 4000°K et 5000°K.
Durée de vie estimée:	Durée de vie moyenne de 50.000 heures estimée.
Installation:	Directement sur la piste électrifiée 220v.
Couleurs:	Blanc, noir, chrome mat et le titane.



Boxter track 13w Boxter rail 13w



Includes driver and LED lamp / Comprend lampe LED et driver

Ref.	Colour / Couleur	Lumens	W	€
5000 01 13 84	White / Blanc	1522	13w	194,70
5000 02 13 84	Black / Noir	1522	13w	199,00
5000 52 13 84	Matt Chrome / Chrome mat	1522	13w	199,00
5000 90 13 84	Titanium / Titane	1522	13w	199,00

* Standardly supplied with maximun lamp opening angle [54°].

* En standard fourni avec angle d'ouverture de la lampe maximun [54°].

* Standardly supplied with 4000° K LED lamp.

* En standard fourni avec lampe 4000° K LED.

Rough price increase of driver / Accessoires

€

Ref. DRDA13 Dimmable driver Dali and track adapter / Driver dimmable Dali et l'adaptateur de rail 65,50

Boxter track 26w Boxter rail 26w



Includes driver and LED lamp / Comprend lampe LED et driver

Ref.	Colour / Couleur	Lumens	W	€
5000 01 26 84	White / Blanc	3045	26w	204,80
5000 02 26 84	Black / Noir	3045	26w	209,50
5000 52 26 84	Matt Chrome / Chrome mat	3045	26w	209,50
5000 90 26 84	Titanium / Titane	3045	26w	209,50

* Standardly supplied with maximun lamp opening angle [54°].

* En standard fourni avec angle d'ouverture de la lampe maximun [54°].

* Standardly supplied with 4000° K LED lamp.

* En standard fourni avec lampe 4000° K LED.

Rough price increase of driver / Accessoires

€

Ref. DRDA26 Dimmable driver Dali and track adapter / Driver dimmable Dali et l'adaptateur de rail 105,40



Video Installation
Vidéo d'installation

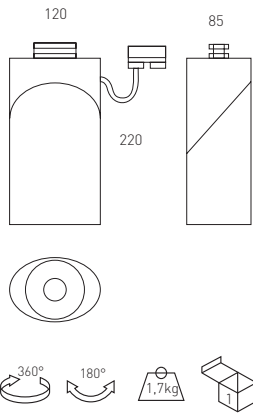

Boxter track 31w
Boxter rail 31w



Includes driver and LED lamp / Comprend lampe LED et driver

Ref.	Colour / Couleur	Lumens	W	€
5000 01 31 84	White / Blanc	4060	31w	223,40
5000 02 31 84	Black / Noir	4060	31w	228,10
5000 52 31 84	Matt Chrome / Chrome mat	4060	31w	228,10
5000 90 31 84	Titanium / Titane	4060	31w	228,10

* Standardly supplied with maximum lamp opening angle [54°].
* En standard fourni avec angle d'ouverture de la lampe maximum [54°].
* Standardly supplied with 4000° K LED lamp.
* En standard fourni avec lampe 4000° K LED.

Rough price increase of driver / Accessoires	€
Ref. DRDA31 Dimmable driver Dali and track adapter / Driver dimmable Dali et l'adaptateur de rail	110,10

Rough price increase of lamp / Accesories	€
Ref. CRI90 CRI > 90	20,60
Ref. 16 Opening angle 16° / Angle d'ouverture 16°	5,60
Ref. 28 Opening angle 28° / Angle d'ouverture 28°	5,80
Ref. 3410 Cover reflector Boxter / Couverture réflecteur Boxter	5,80

Rough price increase of lamp / Icremento rapport à la lampe	13w	26W	31W
Ref. LPF LEDs Fish / Poisson - 4000K - CRI>90	12,00	18,00	19,00
Ref. LPB LEDs Bread / Pain - 3000K - CRI>90	12,00	18,00	19,00
Ref. LCM LEDs Meat / Viande - 2700K - CRI>90	12,00	18,00	19,00
Ref. LVV LEDs Veg. and fruit / Légumes et fruits - 4000K - CRI>90	12,00	18,00	19,00

OPTIONS LED	Ref. 83	Ref. 84	Ref. 85	
CRI>80 / Colour temp./ Temp. de couleur	W	3000°K	4000°K	5000°K
Osram Oslon SSL	13w	1470	1522	1575
	26w	2940	3045	3150
	31w	3920	4060	4200



Recessed Eslim LED

Protection degree **IP44**

Recessed Screen LED, slim thickness, made of extruded aluminum and thermo painted. Includes an innovative optics PMMA, which provides uniform illumination over the whole surface and high luminous efficiency. It can be installed on removable ceiling type Armstrong or in its polyvalent recessed version for other technical ceiling, plaster and plasterboard.

There is a possibility of different finishes, colours and colour temperatures; as well as incorporating dimmable drivers and sensors to adapt the compliance of the CTE.

Eslim LED is the result of combining innovation and simplicity in a luminaire, with great light performance and visual confort, providing a homogeneous and comfortable light.

With only 10.7mm of thickness, Eslim LED is an elegant, simple and minimalist luminaire that is perfectly integrated in commercial environments, work areas and domestic use.

When on, only appreciate light, with nothing around. When off, is integrated as a component in removable type ceilings.

Eslim LED uses LED technology from Osram LED Duris E3 that, thanks to their power and our light distribution, allows a luminaire suitable for any surface.

As it has a very wide emission of light and it is equipped with the light diffusion system, Eslim LED has a low illuminance and glare index; characteristics that allow us to achieve perfect lighting and a wide distribution of light with a high visual comfort.

Material:	Bodies made of thermo painted aluminium coated.
Optics:	New PMMA optic that provides uniform illumination over its entire surface with a minimum thickness of the luminaire.
Supply:	All models include control gear and lamps.
Lamps:	Compose by modules LEDs Osram Duris E3 with total power of 20w, 40w and 60w.
Estimated life:	Estimated life span 40.000 hours.
Installation:	Recessed for removable ceiling profile view, metal and plaster ceilings.
Colours:	White, black, matt chrome and titanium.

Eslim LED recessed Armstrong 40w Eslim LED encastré Armstrong 40w



Includes driver and LED lamp / Comprend lampe LED et drive

Ref.	Colour / Couleur	Measure / Mesures	Lumens	W	€
4212 01 84	White / Blanc	600x600	4000	40w	152,20

* Standardly supplied with 4000° K LED lamp. / En standard fourni avec lampe 4000° K LED.

OPTIONS LED	Ref. 83	Ref. 84	Ref. 85
CRI>80 / Colour temperature / Température de couleur	3000°K	4000°K	5700°K
Lum 40w	3628	4000	4543

Rough price increase of accessories 40w / Accessoires	€
Ref. DR40 Driver dimmable 1-10V / Driver Dimmable 1-10V	49,40
Ref. DRD40 Driver dimmable Dali / Driver dimmable Dali	56,90
Ref. DRP40 Dimmable driver with push button / Dimmable avec bouton poussoir	66,50
Ref. PCFT Lighting control system for DR40 / Eclairage système de contrôle pour DR40	54,90
Ref. DM8 Motion detector integrated in the luminaire / Détecteur de mouvement intégré dans le lum.	30,00
Ref. CF23 Mini flux control integrated in the luminaire / Mini contrôle du flux intégré dans le luminaire	44,00
Ref. 3420 Wire connector for DR40 / Connecteur de fil pour DR40	9,60
Ref. KE1 Emergency Kit 1 hour of autonomy / Kit d'urgence de 1 heure d'autonomie	109,80
Ref. KE2 Emergency Kit 3 hours of autonomy / Kit d'urgence de 3 heures d'autonomie	118,60

Eslim LED encastré

Protection degree **IP44**

Luminaire LED encastré, faible épaisseur, en aluminium extrudé et thermolaqué. Comprend un PMMA optique innovant, qui offre une illumination uniforme sur toute la surface et à haut rendement lumineux. Il peut être installé sur amovible type de plafond Armstrong ou dans son polyvalent version encastrée pour d'autres techniques plafond, plâtre et placoplâtre.

Il est possible de différentes finitions, des couleurs et des températures de couleur; ainsi que l'intégration des pilotes et des capteurs pour adapter l'intensité réglable le respect de la CTE.

Eslim LED est le résultat de la combinaison de l'innovation et de simplicité dans un luminaire, avec de grandes performances de la lumière et de confort visuel, offrant une homogène et la lumière confortable.

Avec seulement 10,7 mm d'épaisseur, Eslim LED est un élégant, simple et minimaliste luminaire qui se intègre parfaitement dans les environnements commerciaux, aires de travail et l'utilisation intérieure.

Lorsqu'elle est activée, seulement apprécier la lumière, avec rien autour. Lorsqu'il est éteint, est intégré comme composant dans des plafonds de type amovible.

Eslim LED utilise la technologie LED d'Osram LED Duris E3 que, grâce à leur pouvoir et de la distribution de notre lumière, permet un luminaire adapté à tout surface.

Comme il a une très grande émission de lumière et il est équipé de la diffusion de la lumière système, Eslim LED a une faible luminosité et de l'indice d'éblouissement; caractéristiques qui nous permettent d'obtenir un éclairage parfait et une large diffusion de la lumière avec un confort visuel élevé.

Matériel:	Corps en aluminium peint enduit thermo.
Optique:	New optiques PMMA qui fournit un éclairage uniforme sur toute sa surface avec une épaisseur minimum de l'appareil d'éclairage.
Alimentation:	Tous les modèles comprennent les ballasts et les lampes.
Lampes:	Composer par des modules LED Osram Duris E3 une puissance totale de 20W, 40w et 60w.
Durée de vie estimée:	Durée de vie estimée de spam 40,000 heures.
Installation:	Encastré au plafond amovible profil vue, métalliques et plafonds en plâtre.
Couleurs:	Blanc, noir, chrome mat et de titane.

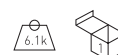
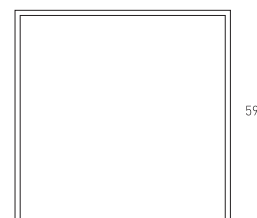
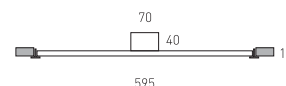

Continuous line Aliket Basic LED suspension

Protection degree **IP44**



Material:	Body made of extruded aluminum with baked paint coating.
Optics:	Novel PMMA transparent or matte optics that provides uniform illumination over the whole surface.
Supply:	All models include adequate equipment and lamps.
Lamps:	Modules by Osram LEDs with total power of 50w with Duris E5 and 75w with Oslon SSL.
Installation:	Suspended.
Colours:	White, black, matt chrome and titanium.

Ligne continue Aliket Basic LED suspension

Degré de protection **IP44**

Matériel:	Corps en aluminium extrudé avec revêtement de peinture cuite.
Optique:	Nouveau PMMA optiques transparents ou mates, qui fournit un éclairage uniforme sur toute la surface.
Alimentation:	Tous les modèles incluent des équipements et des lampes adéquates.
Lampes:	Modules par Osram LEDs avec puissance totale de 50W avec Duris E5 et 75w avec Oslon SSL.
Installation:	Suspendu.
Couleurs:	Blanc, noir, chrome mat et titane



Aliket Basic LED - Suspension - 1437mm 50w matt optical continuous line Aliket Basic LED - Suspension - 1437mm 50w mat optique ligne continue



Includes driver, matt optical and LED Duris E5
Comprend driver, mat optique LED Duris E5

Ref.	Colour / Couleur	W	Lum.	Measu. / Mesures.	€
036 01 1 50 2 84	White / Blanc	50W	5512	1437x65x52	334,95

* Standardly supplied with 4000° K LED lamp.
* En standard fourni avec lampe 4000° K LED.

OPTIONS

Rough price increase of optics / Accessoires		50w
Ref. 1	Transparent / Transparent	1,00
Ref. 3	Asymmetrical 2 sides / Asymétrique 2 côtés	34,95
Ref. 3422	Asymmetrical 1 side / Asymétrique 1 côté	39,00
Ref. 3423	Intensive / Intensif	39,00
Ref. CRI90	CRI>90	35,00

Rough price increase of driver / Accessoires		50w
Ref. DR	Driver dimmable 1-10V / Driver Dimmable 1-10V	63,50
Ref. DRD	Dimmable driver Dali / Driver Dimmable Dali	66,50
Ref. DM8	Motion detector integrated in the luminaire / Détecteur de mouvement intégré dans le luminaire	30,00
Ref. CF23	Mini flux control integrated in the luminaire / Mini contrôle du flux intégré dans le luminaire	44,00
Ref. KE1	Emergency Kit 1 hour of autonomy / Kit d'urgence de 1 heure d'autonomie	109,80
Ref. KE3	Emergency Kit 3 hours of autonomy / Kit d'urgence de 3 heures d'autonomie	118,60
Ref. LI20	Indirect light 20w / lumière indirecte 20w	110,80

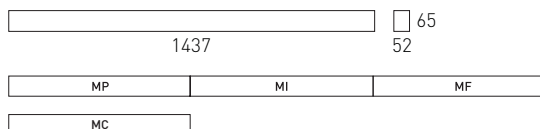

Initial module (MP), intermediate module (MI), final module (MF), closed module (MC)
Module initial (MP), module intermédiaire (MI), module final (MF), Module fermé (MC)

OPTIONS LED

	Ref. 83	Ref. 84	Ref. 85
CRI>80 / Colour temp. / Temp. de couleur	3000°K	4000°K	5700°K
Lum 50w	5486	5512	5512
Lum 20w - Indirect light - lumière indirecte	2250	2275	2275

Rough price increase of lamp / Incremento rapport à la lampe		50w
Ref. LPF	LEDs Fish / Poisson - 4000K - CRI>90	25,00
Ref. LPB	LEDs Bread / Pain - 3000K - CRI>90	25,00
Ref. LCM	LEDs Meat / Viande - 2700K - CRI>90	25,00
Ref. LVV	LEDs Veg. and fruit / Légumes et fruits - 4000K - CRI>90	25,00

* Option to integrate 2 or 3 phases in the luminaire for different switching-on.
* Choice of colors option, see page 469.
* Option modules in other measures 479mm. and 958mm.
(For more information consult the technical department. Secom)
* Possibilité d'intégrer 2 ou 3 phases dans le luminaire pour différents mise en marche.
* Choix de l'option de couleurs, voir page 469.
* Modules optionnels dans d'autres mesures 479mm. et 958mm.
(Pour plus d'informations consulter le service technique. Secom)



Aliket Basic LED - Suspension - 1437mm 75w matt optical continuous line
Aliket Basic LED - Suspension - 1437mm 75w mat optique ligne continue



Includes driver, matt optical and LED Oslon SSL
Comprend driver, mat optique LED Oslon SSL

Ref.	Colour / Couleur	W	Lum.	Measu. / Mesures.	€
036 01 1 75 2 84	White / Blanc	75W	7386	1437x65x52	399,95

* Standardly supplied with 4000° K LED lamp.
* En standard fourni avec lampe 4000° K LED.

OPTIONS

Rough price increase of optics / Accessoires		75w
Ref. 1	Transparent / Transparent	1,00
Ref. 3	Asymmetrical 2 sides / Asymétrique 2 côtés	35,95
Ref. 3421	Symmetrical 150° / Symétrique 150°	4,80
Ref. 3423	Intensive / Intensif	39,00
Ref. CRI90	CRI>90	38,00

Rough price increase of driver / Accessoires		75w
Ref. DR	Driver dimmable 1-10V / Driver Dimmable 1-10V	69,0
Ref. DRD	Dimmable driver Dali / Driver Dimmable Dali	72,90
Ref. DM8	Motion detector integrated in the luminaire / Détecteur de mouvement intégré dans le luminaire	30,00
Ref. CF23	Mini flux control integrated in the luminaire / Mini contrôle du flux intégré dans le luminaire	44,00
Ref. KE1	Emergency Kit 1 hour of autonomy / Kit d'urgence de 1 heure d'autonomie	109,80
Ref. KE3	Emergency Kit 3 hours of autonomy / Kit d'urgence de 3 heures d'autonomie	118,60
Ref. LI20	Indirect light 20w / lumière indirecte 20w	110,80

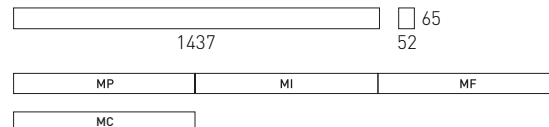

Initial module [MP], intermediate module [MI], final module [MF], closed module [MC]
Module initial [MP], module intermédiaire [MI], module final [MF], Module fermé [MC]

OPTIONS LED

	Ref. 83	Ref. 84	Ref. 85
CRI>80 / Colour temp. / Temp. de couleur	3000°K	4000°K	5700°K
Lum 75w	7140	7386	7386
Lum 20w - Indirect light - lumière indirecte	2250	2275	2275

Rough price increase of lamp / Incremento rapport à la lampe		75W
Ref. LPF	LEDs Fish / Poisson - 4000K - CRI>90	28,00
Ref. LPB	LEDs Bread / Pain - 3000K - CRI>90	28,00
Ref. LCM	LEDs Meat / Viande - 2700K - CRI>90	28,00
Ref. LVV	LEDs Veg. and fruit / Légumes et fruits - 4000K - CRI>90	28,00

* Option to integrate 2 or 3 phases in the luminaire for different switching-on.
* Choice of colors option, see page 469.
* Option modules in other measures 479mm. and 958mm.
(For more information consult the technical department. Secom)
* Possibilité d'intégrer 2 ou 3 phases dans le luminaire pour différents mise en marche.
* Choix de l'option de couleurs, voir page 469.
* Modules optionnels dans d'autres mesures 479mm. et 958mm.
(Pour plus d'informations consulter le service technique. Secom)

Continuous line Aliket Basic LED surface

Protection degree IP44



Material:	Body made of extruded aluminum with baked paint coating.
Optics:	Novel PMMA transparent or matte optics that provides uniform illumination over the whole surface.
Supply:	All models include adequate equipment and lamps.
Lamps:	Modules by Osram LEDs with total power of 50w with Duris E5 and 75w with Oslon SSL.
Installation:	Surface.
Colours:	White, black, matt chrome and titanium.

Ligne continue Aliket Basic LED saillie

Degré de protection IP44

Matériel:	Corps en aluminium extrudé avec revêtement de peinture cuite.
Optique:	Nouveau PMMA optiques transparents ou mates, qui fournit un éclairage uniforme sur toute la surface.
Alimentation:	Tous les modèles incluent des équipements et des lampes adéquates.
Lampes:	Modules par Osram LEDs avec puissance totale de 50W avec Duris E5 et 75w avec Oslon SSL.
Installation:	Saillie.
Couleurs:	Blanc, noir, chrome mat et titane.



Aliket Basic LED - Surface - 1437mm 50w matt optical continuous line
Aliket Basic LED - Saillie - 1437mm 50w mat optique ligne continue



Includes driver, matt optical and LED Duris E5
Comprend driver, mat optique LED Duris E5

Ref.	Colour / Couleur	W	Lum.	Measu. / Mesures.	€
034 01 1 50 2 84	White / Blanc	50W	5512	1437x65x52	334,90

* Standardly supplied with 4000° K LED lamp.
* En standard fourni avec lampe 4000° K LED.

OPCIONES / OPTIONS

Rough price increase of optics / Accessoires		50w
Ref. 1	Transparent / Transparent	1,00
Ref. 3	Asymmetrical 2 sides / Asymétrique 2 côtés	34,95
Ref. 3422	Asymmetrical 1 side / Asymétrique 1 côté	39,00
Ref. 3423	Intensive / Intensif	39,00
Ref. CRI90	CRI>90	35,00

Rough price increase of driver / Accessoires

Rough price increase of driver / Accessoires		50w
Ref. DR	Driver dimmable 1-10V / Driver Dimmable 1-10V	63,50
Ref. DRD	Dimmable driver Dali / Driver Dimmable Dali	66,50
Ref. DM8	Motion detector integrated in the luminaire / Détecteur de mouvement intégré dans le lum.	30,00
Ref. CF23	Mini flux control integrated in the luminaire / Mini contrôle du flux intégré dans le luminaire	44,00
Ref. KE1	Emergency Kit 1 hour of autonomy / Kit d'urgence de 1 heure d'autonomie	109,80
Ref. KE3	Emergency Kit 3 hours of autonomy / Kit d'urgence de 3 heures d'autonomie	118,60

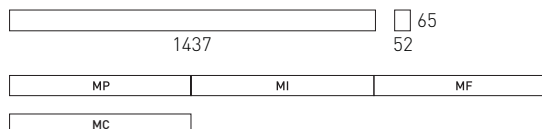

Initial module (MP), intermediate module (MI), final module (MF), closed module (MC)
Module initial (MP), module intermédiaire (MI), module final (MF), Module fermé (MC)

OPTIONS LED	Ref. 83	Ref. 84	Ref. 85
CRI>80 / Colour temp. / Temp. de couleur	3000°K	4000°K	5700°K
Lum 50w	5486	5512	5512

Rough price increase of lamp / Incremento rapport à la lampe

Rough price increase of lamp / Incremento rapport à la lampe		50W
Ref. LPF	LEDs Fish / Poisson - 4000K - CRI>90	25,00
Ref. LPB	LEDs Bread / Pain - 3000K - CRI>90	25,00
Ref. LCM	LEDs Meat / Viande - 2700K - CRI>90	25,00
Ref. LVV	LEDs Veg. and fruit / Légumes et fruits - 4000K - CRI>90	25,00

* Option to integrate 2 or 3 phases in the luminaire for different switching-on.
* Choice of colors option, see page 469.
* Option modules in other measures 479mm. and 958mm.
(For more information consult the technical department. Secom)
* Possibilité d'intégrer 2 ou 3 phases dans le luminaire pour différents mise en marche.
* Choix de l'option de couleurs, voir page 469.
* Modules optionnels dans d'autres mesures 479mm. et 958mm.
(Pour plus d'informations consulter le service technique. Secom)



Aliket Basic LED - Surface - 1437mm 75w matt optical continuous line
Aliket Basic LED - Saillie - 1437mm 75w mat optique ligne continue



Includes driver, matt optical and LED Oslon SSL
Comprend driver, mat optique LED Oslon SSL

Ref.	Colour / Couleur	W	Lum.	Measu. / Mesures.	€
034 01 1 75 2 84	White / Blanc	75W	7386	1437x65x52	399,90

* Standardly supplied with 4000° K LED lamp.
* En standard fourni avec lampe 4000° K LED.

OPTIONS

Rough price increase of optics / Accessoires		75w
Ref. 1	Transparent / Transparent	1,00
Ref. 3	Asymmetrical 2 sides / Asymétrique 2 côtés	34,95
Ref. 3421	Symmetrical 150° / Symétrique 150°	4,80
Ref. 3423	Intensive / Intensif	39,00
Ref. CRI90	CRI>90	38,00

Rough price increase of driver / Accessoires		75w
Ref. DR	Driver dimmable 1-10V / Driver Dimmable 1-10V	69,90
Ref. DRD	Dimmable driver Dali / Driver Dimmable Dali	72,90
Ref. DM8	Motion detector integrated in the luminaire / Détecteur de mouvement intégré dans le luminaire	30,00
Ref. CF23	Mini flux control integrated in the luminaire / Mini contrôle du flux intégré dans le luminaire	44,00
Ref. KE1	Emergency Kit 1 hour of autonomy / Kit d'urgence de 1 heure d'autonomie	109,80
Ref. KE3	Emergency Kit 3 hours of autonomy / Kit d'urgence de 3 heures d'autonomie	118,60

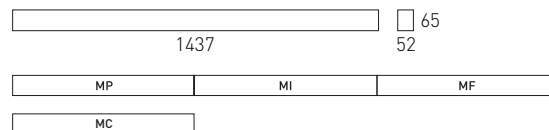

Initial module (MP), intermediate module (MI), final module (MF), closed module (MC)
Module initial (MP), module intermédiaire (MI), module final (MF), Module fermé (MC)

OPTIONS LED

	Ref. 83	Ref. 84	Ref. 85
CRI>80 / Colour temp./ Temp. de couleur	3000°K	4000°K	5700°K
Lum 75w	7140	7386	7386

Rough price increase of lamp / Incremento rapport à la lampe		75W
Ref. LPF	LEDs Fish / Poisson - 4000K - CRI>90	28,00
Ref. LPB	LEDs Bread / Pain - 3000K - CRI>90	28,00
Ref. LCM	LEDs Meat / Viande - 2700K - CRI>90	28,00
Ref. LVV	LEDs Veg. and fruit / Légumes et fruits - 4000K - CRI>90	28,00

* Option to integrate 2 or 3 phases in the luminaire for different switching-on.
* Choice of colors option, see page 469.
* Option modules in other measures 479mm. and 958mm.
[For more information consult the technical department. Secom]
* Possibilité d'intégrer 2 ou 3 phases dans le luminaire pour différents mise en marche.
* Choix de l'option de couleurs, voir page 469.
* Modules optionnels dans d'autres mesures 479mm. et 958mm.
[Pour plus d'informations consulter le service technique. Secom]

Continuous line Aliket Basic LED recessed

Protection degree IP44



Material:	Body made of extruded aluminum with baked paint coating.
Optics:	Novel PMMA transparent or matte optics that provides uniform illumination over the whole surface.
Supply:	All models include adequate equipment and lamps.
Lamps:	Modules by Osram LEDs with total power of 50w with Duris E5 and 75w with Oslon SSL.
Installation:	Recessed.
Colours:	White, black, matt chrome and titanium.

Ligne continue Aliket Basic LED encastré

Degré de protection IP44

Matériel:	Corps en aluminium extrudé avec revêtement de peinture cuite.
Optique:	Nouveau PMMA optiques transparents ou mates, qui fournit un éclairage uniforme sur toute la surface.
Alimentation:	Tous les modèles incluent des équipements et des lampes adéquates.
Lampes:	Modules par Osram LEDs avec puissance totale de 50W avec Duris E5 et 75w avec Oslon SSL.
Installation:	Encastré.
Couleurs:	Blanc, noir, chrome mat et titane.



Aliket Basic LED - Recessed - 1437mm 50w matt optical continuous line Aliket Basic LED - Encastré - 1437mm 50w mat optique ligne continue



Includes driver, matt optical and LED Duris E5
Comprend driver, mat optique LED Duris E5

Ref.	Colour / Couleur	W	Lum.	Measu. / Mesures.	€
035 01 1 50 2 84	White / Blanc	50W	5512	1437x65x52	434,45

* Standardly supplied with 4000° K LED lamp.
* En standard fourni avec lampe 4000° K LED.

OPTIONS

Rough price increase of optics / Accessoires		50w
Ref. 1	Transparent / Transparent	1,00
Ref. 3	Asymmetrical 2 sides / Asymétrique 2 côtés	34,95
Ref. 3422	Asymmetrical 1 side / Asymétrique 1 côté	39,00
Ref. 3423	Intensive / Intensif	39,00
Ref. CRI90	CRI>90	35,00

Rough price increase of driver / Accessoires		50w
Ref. DR	Driver dimmable 1-10V / Driver Dimmable 1-10V	63,50
Ref. DRD	Dimmable driver Dali / Driver Dimmable Dali	66,50
Ref. DM8	Motion detector integrated in the luminaire / Détecteur de mouvement intégré dans le lum.	30,00
Ref. CF23	Mini flux control integrated in the luminaire / Mini contrôle du flux intégré dans le luminaire	44,00
Ref. KE1	Emergency Kit 1 hour of autonomy / Kit d'urgence de 1 heure d'autonomie	109,80
Ref. KE3	Emergency Kit 3 hours of autonomy / Kit d'urgence de 3 heures d'autonomie	118,60

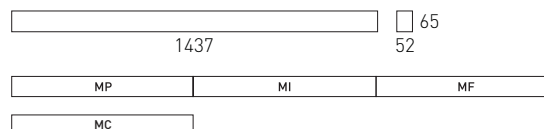

Initial module (MP), intermediate module (MI), final module (MF), closed module (MC)
Module initial (MP), module intermédiaire (MI), module final (MF), Module fermé (MC)

OPCIONES / OPTIONS LED	Ref. 83	Ref. 84	Ref. 85
CRI>80 / Colour temp. / Temp. de couleur	3000°K	4000°K	5700°K
Lum 50w	5486	5512	5512

Rough price increase of lamp / Incremento rapport à la lampe		50W
Ref. LPF	LEDs Fish / Poisson - 4000K - CRI>90	25,00
Ref. LPB	LEDs Bread / Pain - 3000K - CRI>90	25,00
Ref. LCM	LEDs Meat / Viande - 2700K - CRI>90	25,00
Ref. LVV	LEDs Veg. and fruit / Légumes et fruits - 4000K - CRI>90	25,00

* Option to integrate 2 or 3 phases in the luminaire for different switching-on.
* Choice of colors option, see page 469.
* Option modules in other measures 479mm. and 958mm.
[For more information consult the technical department. Secom]
* Possibilité d'intégrer 2 ou 3 phases dans le luminaire pour différents mise en marche.
* Choix de l'option de couleurs, voir page 469.
* Modules optionnels dans d'autres mesures 479mm. et 958mm.
[Pour plus d'informations consulter le service technique. Secom]



Aliket Basic LED - Recessed - 1437mm 75w matt optical continuous line
Aliket Basic LED - Encastré - 1437mm 75w mat optique ligne continue



Includes driver, matt optical and LED Oslon SSL
Comprend driver, mat optique LED Oslon SSL

Ref.	Colour / Couleur	W	Lum.	Measu. / Mesures.	€
035 01 1 75 2 84	White / Blanc	75W	7386	1437x65x52	499,45

* Standardly supplied with 4000° K LED lamp.
* En standard fourni avec lampe 4000° K LED.

OPTIONS

Rough price increase of optics / Accessoires		75w
Ref. 1	Transparent / Transparent	1,00
Ref. 3	Asymmetrical 2 sides / Asymétrique 2 côtés	34,95
Ref. 3421	Symmetrical 150° / Symétrique 150°	4,80
Ref. 3423	Intensive / Intensif	39,00
Ref. CRI90	CRI>90	38,00

Incremento respecto al driver / Rough price increase of driver		75w
Ref. DR	Driver dimmable 1-10V / Driver Dimmable 1-10V	69,90
Ref. DRD	Dimmable driver Dali / Driver Dimmable Dali	72,90
Ref. DM8	Motion detector integrated in the luminaire / Détecteur de mouvement intégré dans le lum.	30,00
Ref. CF23	Mini flux control integrated in the luminaire / Mini contrôle du flux intégré dans le luminaire	44,00
Ref. KE1	Emergency Kit 1 hour of autonomy / Kit d'urgence de 1 heure d'autonomie	109,80
Ref. KE3	Emergency Kit 3 hours of autonomy / Kit d'urgence de 3 heures d'autonomie	118,60

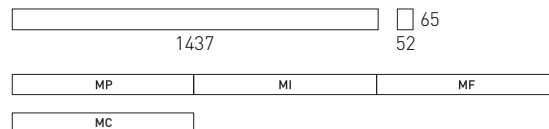

Initial module (MP), intermediate module (MI), final module (MF), closed module (MC)
Module initial (MP), module intermédiaire (MI), module final (MF), Module fermé (MC)

OPCIONES / OPTIONS LED	Ref. 83	Ref. 84	Ref. 85
CRI>80 / Colour temp. / Temp. de couleur	3000°K	4000°K	5700°K
Lum 75w	7140	7386	7386

Rough price increase of lamp / Incremento rapport à la lampe		75W
Ref. LPF	LEDs Fish / Poisson - 4000K - CRI>90	28,00
Ref. LPB	LEDs Bread / Pain - 3000K - CRI>90	28,00
Ref. LCM	LEDs Meat / Viande - 2700K - CRI>90	28,00
Ref. LWV	LEDs Veg. and fruit / Légumes et fruits - 4000K - CRI>90	28,00

* Option to integrate 2 or 3 phases in the luminaire for different switching-on.
* Choice of colors option, see page 469.
* Option modules in other measures 479mm. and 958mm.
[For more information consult the technical department. Secom]
* Possibilité d'intégrer 2 ou 3 phases dans le luminaire pour différents mise en marche.
* Choix de l'option de couleurs, voir page 469.
* Modules optionnels dans d'autres mesures 479mm. et 958mm.
[Pour plus d'informations consulter le service technique. Secom]

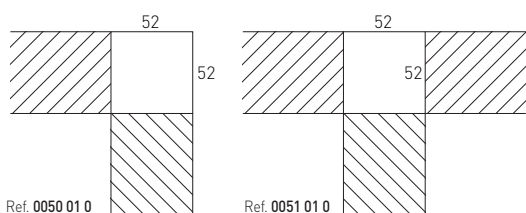
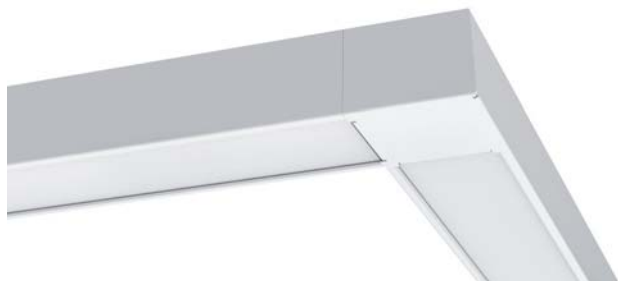

Aliket Basic Led blind joint continuous line / Aliket Basic LED coude aveugle ligne continue

Ref.	Colour / Couleur	Measu. / Mesures	€
0050 01 0	White/Blanc	52x52	119,90
0051 01 0	White/Blanc	52x52	119,90



Aliket Basic LED stretch blind / Aliket Basic LED aveugle stretch

Ref.	Aliket	Stretch blind Aveugle stretch	€
0070	719mm	Initial module / Module initial MP	78,90
0071	719mm	Intermediate module / Module intermédiaire MI	78,90
0072	719mm	Final module / Module final MF	78,90
0140	1437mm	Initial module / Module initial MP	128,90
0141	1437mm	Intermediate module / Module intermédiaire MI	128,90
0142	1437mm	Final module / Module final MF	128,90

* Option stretch blind in other measures

(For more information consult the technical department. Secom)

* Option aveugle stretch dans d'autres mesures

(Pour plus d'informations consulter le service technique Secom)



Aliket Basic LED suspension kit / Aliket Basic LED kit de suspension

Ref.	Aliket	Cable length Longueur du câble	Units per luminaire Unids. per luminaire	€
7001	719mm	1200mm	2	20,60
7002	719mm	2000mm	2	20,60
7003	719mm	3000mm	2	20,60
1401	1437mm	1200mm	2	20,60
1402	1437mm	2000mm	2	20,60
1403	1437mm	3000mm	2	20,60

* Suspension available in other lengths (on request).

* Suspension disponible dans d'autres longueurs (sur demande).

Aliket Basic LED fixing for threaded rod M4 / Aliket Basic LED fixation pour tige filetée M4

Ref.	Fixing / Fixation	Aliket	Units per luminaire Unids. per luminaire	€
FVR14	For hreaded rod / Pour tige filetée	1437mm	3	9,00

Aliket Basic LED fixing for chain 2x12mm / Aliket Basic LED la chaîne de fixation 2x12mm

Ref.	Fixing / Fixation	Aliket	Units per luminaire Unids. per luminaire	€
FC14	For chain / Pour chaîne	1437mm	3	11,00



Aliket LED kit chain 2x12mm / Aliket LED kit chaîne 2x12mm

Ref.	Aliket	Cable length Longueur du câble	Units per luminaire Unids. per luminaire	€
1404	1437mm	1000mm	3	18,90
1405	1437mm	2000mm	3	26,80
1406	1437mm	3000mm	3	34,70

* Fixing available in other lengths (on request).

* Fixation disponible dans d'autres longueurs (sur demande).



Continuous line Aliket LED

Protection degree **IP44**



Material:	Body made of extruded aluminum with baked paint coating.
Optics:	New PMMA transparent or matte optics that provides uniform illumination over the whole surface.
Supply:	All models include adequate equipment and lamps.
Lamps:	Modules by Osram LEDs with total power of 20W, 40W and 50W with Duris E5 and 30W, 60W or 75W by Osloom SSL.
Installation:	Directly to the ceiling or suspended.
Colours:	White, black, matt chrome and titanium.

Aliket LED rangée continue

Degré de protection **IP44**

Matériel:	Corps fabriqué en aluminium injecté avec une couverture de peinture au four.
Optique:	Nouvelle optique de PMMA transparente ou mat qui proportionne un éclairage homogène dans toute sa superficie.
Alimentation:	Tous les modèles incluent équipes et lampes adéquats.
Lamps:	Modules composés par LEDs Osram avec des potences totales de 20W, 40W et 50W avec LEDs Duris E5. Et 30W, 60W ou 75W avec LEDs Osloom SSL.
Installation:	Directement sur le toit ou en suspension.
Colours:	Blanc, noir, chôme mat et titane.



100,80
600
65,60

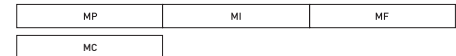

Aliket LED 600mm 20w transparent optical continuous line Ligne continue



Includes driver, transparent optical and LED Duris E5
Comprend driver, optique transparente LED Duris E5

Initial module (MP), intermediate module (MI), final module (MF), closed module (MC)
Module initial (MP), module intermédiaire (MI), module final (MF), Module fermé (MC)

Ref.	Colour / Couleur	W	Lum.	Measu. / Mesures	€
037 01 1 20 1 84 MP	White/Blanc	20W	2100	600x100,80x65,60	224,90
037 01 1 20 1 84 MI	White/Blanc	20W	2100	600x100,80x65,60	224,90
037 01 1 20 1 84 MF	White/Blanc	20W	2100	600x100,80x65,60	224,90
037 01 1 20 1 84 MC	White/Blanc	20W	2100	600x100,80x65,60	224,90

* Standardly supplied with 4000° K LED lamp.
* En standard fourni avec lampe 4000° K LED.

Aliket LED 600mm 20w asymmetric optical continuous line Ligne continue



Includes driver, asymmetric optical and LED Duris E5
Comprend driver, optique asymétrique LED Duris E5

Initial module (MP), intermediate module (MI), final module (MF), closed module (MC)
Module initial (MP), module intermédiaire (MI), module final (MF), Module fermé (MC)

Ref.	Colour / Couleur	W	Lum.	Med. / Mesures	€
037 01 1 20 3 84 MP	White/Blanc	20W	1953	600x100,80x65,60	259,60
037 01 1 20 3 84 MI	White/Blanc	20W	1953	600x100,80x65,60	259,60
037 01 1 20 3 84 MF	White/Blanc	20W	1953	600x100,80x65,60	259,60
037 01 1 20 3 84 MC	White/Blanc	20W	1953	600x100,80x65,60	259,60

* Standardly supplied with 4000° K LED lamp.
* En standard fourni avec lampe 4000° K LED.

A Aliket LED 600mm 20w matt optical continuous line Ligne continue



Includes driver, matt optical and LED Duris E5
Comprend driver, mat optique LED Duris E5

Initial module (MP), intermediate module (MI), final module (MF), closed module (MC)
Module initial (MP), module intermédiaire (MI), module final (MF), Module fermé (MC)

Ref.	Colour / Couleur	W	Lum.	Med. / Mesures	€
037 01 1 20 2 84 MP	White/Blanc	20W	2100	600x100,80x65,60	224,90
037 01 1 20 2 84 MI	White/Blanc	20W	2100	600x100,80x65,60	224,90
037 01 1 20 2 84 MF	White/Blanc	20W	2100	600x100,80x65,60	224,90
037 01 1 20 2 84 MC	White/Blanc	20W	2100	600x100,80x65,60	224,90

* Standardly supplied with 4000° K LED lamp.
* En standard fourni avec lampe 4000° K LED.

OPTIONS LED	Ref. 83	Ref. 84	Ref. 85	Ref. 85
CRI>80 / Colour temp. / Temp. de couleur	3000°K	4000°K	5000°K	5700°K
Lum 20w	2090	2100	-	2100
Lum 30w	2730	3150	3150	-



Aliket LED 600mm 30w transparent optical continuous line
Ligne continue



Includes driver, transparent optical and LED Oslon SSL
Comprend driver, optique transparent LED Oslon SSL

Initial module (MP), intermediate module (MI), final module (MF), closed module (MC)
Module initial (MP), module intermédiaire (MI), module final (MF), Module fermé (MC)

Ref.	Colour / Couleur	W	Lum.	Measu. / Mesures	€
037 01 1 30 1 84 MP	White/Blanc	30W	3150	600x100,80x65,60	259,90
037 01 1 30 1 84 MI	White/Blanc	30W	3150	600x100,80x65,60	259,90
037 01 1 30 1 84 MF	White/Blanc	30W	3150	600x100,80x65,60	259,90
037 01 1 30 1 84 MC	White/Blanc	30W	3150	600x100,80x65,60	259,90

* Standardly supplied with 4000° K LED lamp.
* En standard fourni avec lampe 4000° K LED.

Aliket LED 600mm 30w matt optical continuous line
Ligne continue



Includes driver, matt optical and LED Oslon SSL
Comprend driver, mat optique LED Oslon SSL

Initial module (MP), intermediate module (MI), final module (MF), closed module (MC)
Module initial (MP), module intermédiaire (MI), module final (MF), Module fermé (MC)

Ref.	Colour / Couleur	W	Lum.	Med. / Mesures	€
037 01 1 30 2 84 MP	White/Blanc	30W	3150	600x100,80x65,60	259,90
037 01 1 30 2 84 MI	White/Blanc	30W	3150	600x100,80x65,60	259,90
037 01 1 30 2 84 MF	White/Blanc	30W	3150	600x100,80x65,60	259,90
037 01 1 30 2 84 MC	White/Blanc	30W	3150	600x100,80x65,60	259,90

* Standardly supplied with 4000° K LED lamp.
* En standard fourni avec lampe 4000° K LED.

Aliket LED 600mm 30w asymmetric optical continuous line
Ligne continue



Includes driver, asymmetric optical and LED Oslon SSL
Comprend driver, optique asymétrique LED Oslon SSL

Initial module (MP), intermediate module (MI), final module (MF), closed module (MC)
Module initial (MP), module intermédiaire (MI), module final (MF), Module fermé (MC)

Ref.	Colour / Couleur	W	Lum.	Med. / Mesures	€
037 01 1 30 3 84 MP	White/Blanc	30W	2929	600x100,80x65,60	298,90
037 01 1 30 3 84 MI	White/Blanc	30W	2929	600x100,80x65,60	298,90
037 01 1 30 3 84 MF	White/Blanc	30W	2929	600x100,80x65,60	298,90
037 01 1 30 3 84 MC	White/Blanc	30W	2929	600x100,80x65,60	298,90

* Standardly supplied with 4000° K LED lamp.
* En standard fourni avec lampe 4000° K LED.

Rough price increase of accessories / Accessoires		20w	30w
Ref. DRD	Dimmable driver Dali / Driver Dimmable Dali	66,55	66,55
Ref. KE1	Emer. kit 1h. of autonomy / Kit d'urgence de 1 h. autonomie	116,20	116,20
Ref. KE3	Emer. kit 3h. of autonomy / Kit d'urgence de 3 h. autonomie	121,80	121,80
Ref. CRI90	CRI>90	12,80	15,40

Rough price increase of the finished frame / Augmentation châssis Terminer		€
Color other than white / Couleur autre que blanche		14,90

Rough price increase of lamp / Incremento rapport à la lampe		20w	30w
Ref. LPF	LEDs Fish / Poisson - 4000K - CRI>90	18,00	19,00
Ref. LPB	LEDs Bread / Pain - 3000K - CRI>90	18,00	19,00
Ref. LCM	LEDs Meat / Viande - 2700K - CRI>90	18,00	19,00
Ref. LVV	LEDs Veg. and fruit / Légumes et fruits - 4000K - CRI>90	18,00	19,00

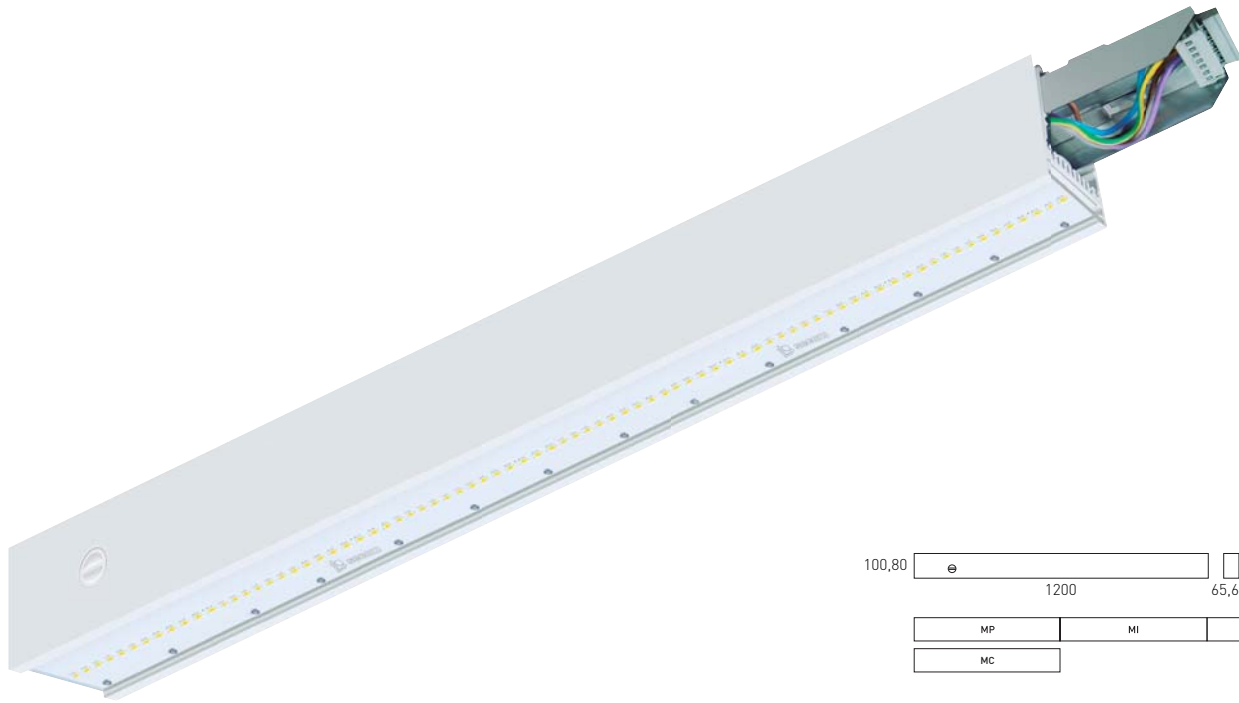

Aliket LED 1200mm 40w transparent optical continuous line Ligne continue



Includes driver, transparent optical and LED Duris E5

Comprend driver, optique transparente LED Duris E5

Initial module (MP), intermediate module (MI), final module (MF), closed module (MC)
Module initial (MP), module intermédiaire (MI), module final (MF), Module fermé (MC)

Ref.	Colour / Couleur	W	Lum.	Measu. / Mesures	€
037 01 2 40 1 84 MP	White/Blanc	40W	4200	1200x100,80x65,60	357,93
037 01 2 40 1 84 MI	White/Blanc	40W	4200	1200x100,80x65,60	357,93
037 01 2 40 1 84 MF	White/Blanc	40W	4200	1200x100,80x65,60	357,93
037 01 2 40 1 84 MC	White/Blanc	40W	4200	1200x100,80x65,60	357,93

* Standardly supplied with 4000° K LED lamp.

* En standard fourni avec lampe 4000° K LED.

Aliket LED 1200mm 40w asymmetric optical continuous line Ligne continue



Includes driver, asymmetric optical and LED Duris E5

Comprend driver, optique asymétrique LED Duris E5

Initial module (MP), intermediate module (MI), final module (MF), closed module (MC)
Module initial (MP), module intermédiaire (MI), module final (MF), Module fermé (MC)

Ref.	Colour / Couleur	W	Lum.	Measu. / Mesures	€
037 01 2 40 3 84 MP	White/Blanc	40W	3906	1200x100,80x65,60	412,80
037 01 2 40 3 84 MI	White/Blanc	40W	3906	1200x100,80x65,60	412,80
037 01 2 40 3 84 MF	White/Blanc	40W	3906	1200x100,80x65,60	412,80
037 01 2 40 3 84 MC	White/Blanc	40W	3906	1200x100,80x65,60	412,80

* Standardly supplied with 4000° K LED lamp.

* En standard fourni avec lampe 4000° K LED.

Aliket LED 1200mm 40w matt optical continuous line Ligne continue



Includes driver, matt optical and LED Duris E5

Comprend driver, mat optique LED Duris E5

Initial module (MP), intermediate module (MI), final module (MF), closed module (MC)
Module initial (MP), module intermédiaire (MI), module final (MF), Module fermé (MC)

Ref.	Colour / Couleur	W	Lum.	Measu. / Mesures	€
037 01 2 40 2 84 MP	White/Blanc	40W	4200	1200x100,80x65,60	357,93
037 01 2 40 2 84 MI	White/Blanc	40W	4200	1200x100,80x65,60	357,93
037 01 2 40 2 84 MF	White/Blanc	40W	4200	1200x100,80x65,60	357,93
037 01 2 40 2 84 MC	White/Blanc	40W	4200	1200x100,80x65,60	357,93

* Standardly supplied with 4000° K LED lamp.

* En standard fourni avec lampe 4000° K LED.

OPTIONS LED	Ref. 83	Ref. 84	Ref. 85	Ref. 85
CRI>80 / Colour temp. / Temp. de couleur	3000°K	4000°K	5000°K	5700°K
Lum 40w	4180	4200	-	4200
Lum 60w	5460	6300	6300	-

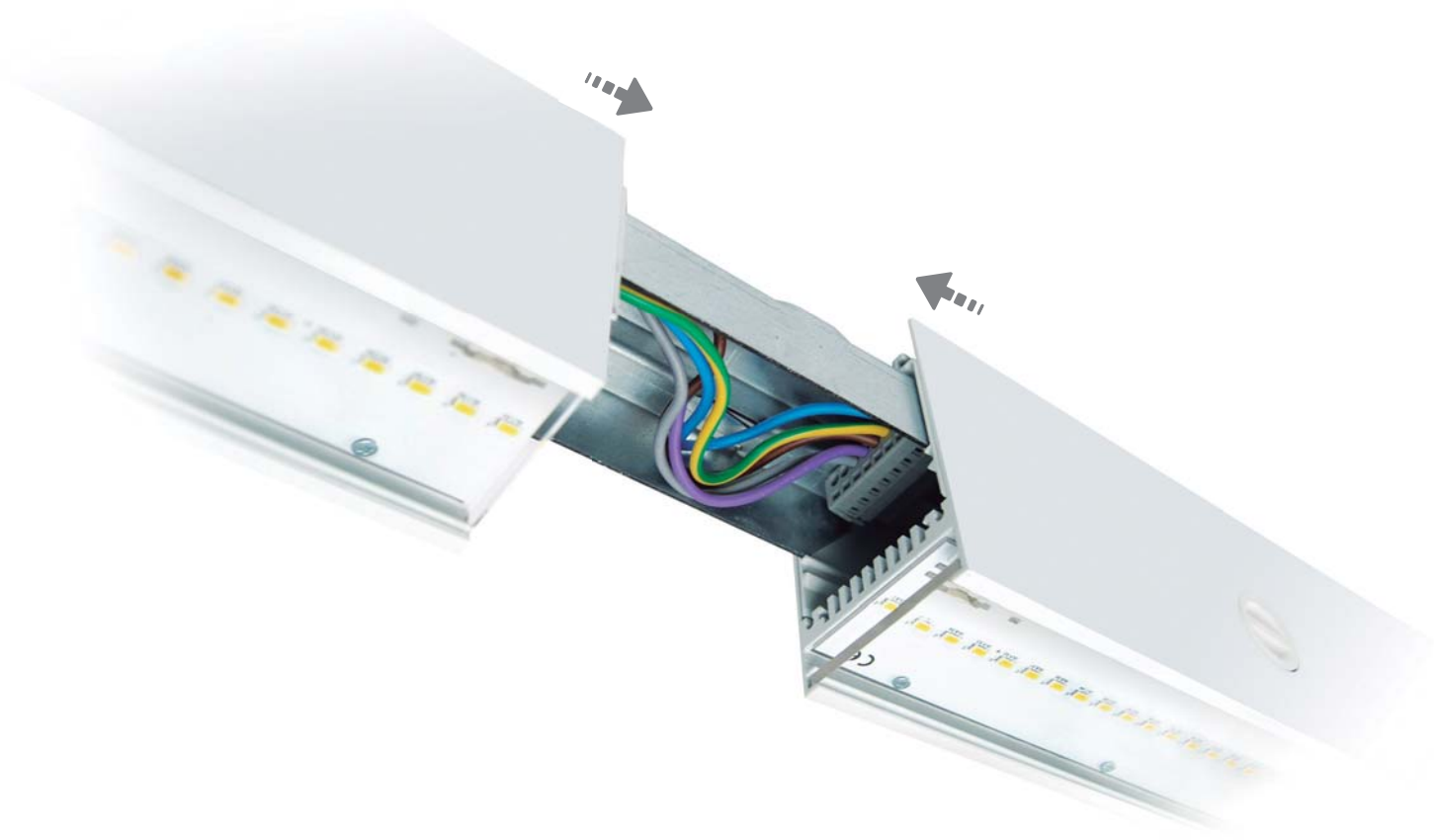

Aliket LED 1200mm 60w transparent optical continuous line
Ligne continue



Includes driver, transparent optical and LED Oslon SSL
Comprend driver, optique transparent LED Oslon SSL

Initial module (MP), intermediate module (MI), final module (MF), closed module (MC)
Module initial (MP), module intermédiaire (MI), module final (MF), Module fermé (MC)

Ref.	Colour / Couleur	W	Lum.	Measu. / Mesures	€
037 01 2 60 1 84 MP	White/Blanc	60W	6300	1200x100,80x65,60	395,80
037 01 2 60 1 84 MI	White/Blanc	60W	6300	1200x100,80x65,60	395,80
037 01 2 60 1 84 MF	White/Blanc	60W	6300	1200x100,80x65,60	395,80
037 01 2 60 1 84 MC	White/Blanc	60W	6300	1200x100,80x65,60	395,80

* Standardly supplied with 4000° K LED lamp.
* En standard fourni avec lampe 4000° K LED.

Aliket LED 1200mm 60w asymmetric optical continuous line
Ligne continue



Includes driver, asymmetric optical and LED Oslon SSL
Comprend driver, optique asymétrique LED Oslon SSL

Initial module (MP), intermediate module (MI), final module (MF), closed module (MC)
Module initial (MP), module intermédiaire (MI), module final (MF), Module fermé (MC)

Ref.	Colour / Couleur	W	Lum.	Med. / Mesures	€
037 01 2 60 3 84 MP	White/Blanc	60W	5859	1200x100,80x65,60	452,20
037 01 2 60 3 84 MI	White/Blanc	60W	5859	1200x100,80x65,60	452,20
037 01 2 60 3 84 MF	White/Blanc	60W	5859	1200x100,80x65,60	452,20
037 01 2 60 3 84 MC	White/Blanc	60W	5859	1200x100,80x65,60	452,20

* Standardly supplied with 4000° K LED lamp.
* En standard fourni avec lampe 4000° K LED.

Aliket LED 1200mm 60w matt optical continuous line
Ligne continue



Includes driver, matt optical and LED Oslon SSL
Comprend driver, mat optique LED Oslon SSL

Initial module (MP), intermediate module (MI), final module (MF), closed module (MC)
Module initial (MP), module intermédiaire (MI), module final (MF), Module fermé (MC)

Ref.	Colour / Couleur	W	Lum.	Measu. / Mesures	€
037 01 2 60 2 84 MP	White/Blanc	60W	6300	1200x100,80x65,60	395,80
037 01 2 60 2 84 MI	White/Blanc	60W	6300	1200x100,80x65,60	395,80
037 01 2 60 2 84 MF	White/Blanc	60W	6300	1200x100,80x65,60	395,80
037 01 2 60 2 84 MC	White/Blanc	60W	6300	1200x100,80x65,60	395,80

* Standardly supplied with 4000° K LED lamp.
* En standard fourni avec lampe 4000° K LED.

Rough price increase of accessories / Accessoires

Ref.	40w	60w
DRD Dimmable driver Dali / Driver Dimmable Dali	66,55	66,55
KE1 Emer. kit 1h. of autonomy / Kit d'urgence de 1 h. autonomie	116,20	116,20
KE3 Emer. kit 3h. of autonomy / Kit d'urgence de 3 h. autonomie	121,80	121,80
CR190 CRI>90	25,60	30,80

Rough price increase of the finished frame / Augmentation châssis Terminer

Color other than white / Couleur autre que blanche	€
	25,90

Rough price increase of lamp / Incremento rapport à la lampe

Ref.	40w	60w
LPF LEDs Fish / Poisson - 4000K - CRI>90	20,00	22,00
LPB LEDs Bread / Pain - 3000K - CRI>90	20,00	22,00
LCM LEDs Meat / Viande - 2700K - CRI>90	20,00	22,00
LJV LEDs Veg. and fruit / Légumes et fruits - 4000K - CRI>90	20,00	22,00

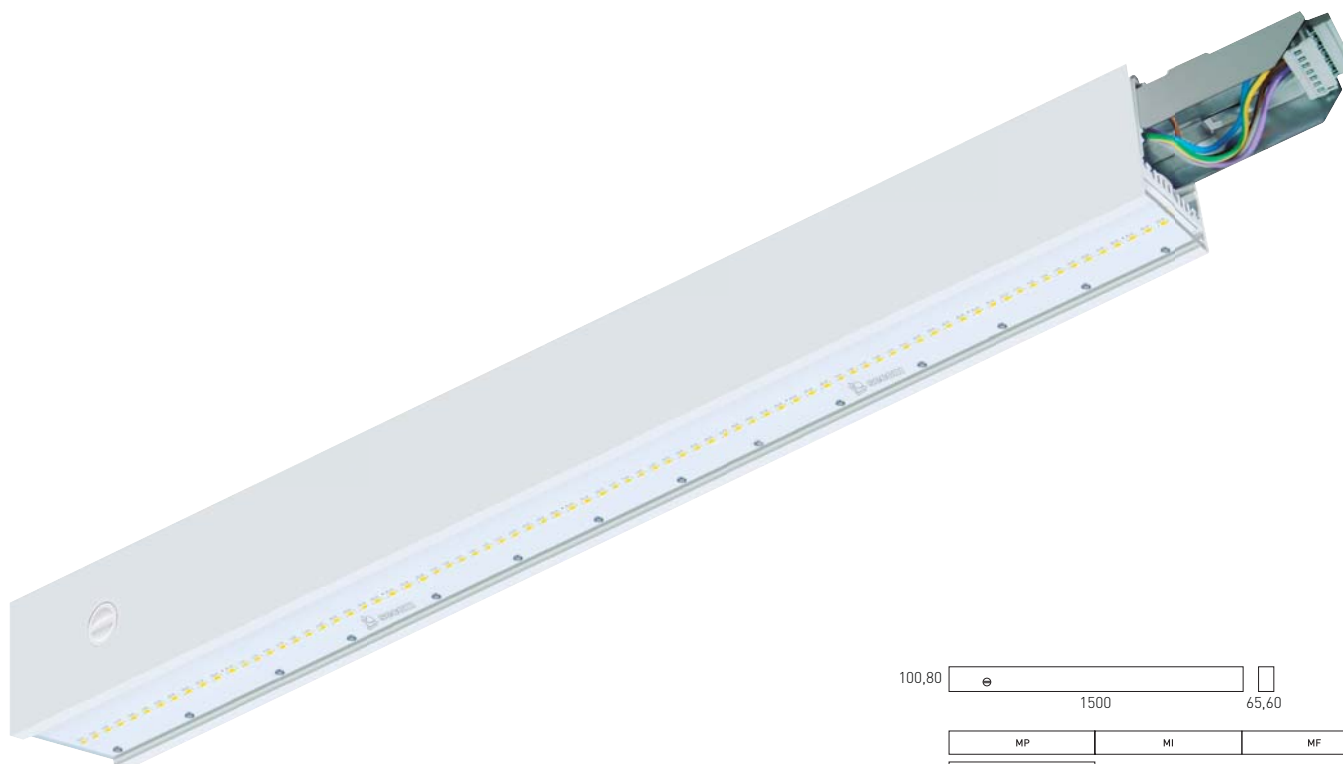

Aliket LED 1500mm 50w transparent optical continuous line Ligne continue



Includes driver, transparent optical and LED Duris E5
Comprend driver, optique transparent LED Duris E5

Initial module (MP), intermediate module (MI), final module (MF), closed module (MC)
Module initial (MP), module intermédiaire (MI), module final (MF), Module fermé (MC)

Ref.	Colour / Couleur	W	Lum.	Measu. / Mesures	€
037 01 4 50 1 84 MP	White/Blanc	50W	5512	1500x100,80x65,60	442,90
037 01 4 50 1 84 MI	White/Blanc	50W	5512	1500x100,80x65,60	442,90
037 01 4 50 1 84 MF	White/Blanc	50W	5512	1500x100,80x65,60	442,90
037 01 4 50 1 84 MC	White/Blanc	50W	5512	1500x100,80x65,60	442,90

* Standardly supplied with 4000° K LED lamp.
* En standard fourni avec lampe 4000° K LED.

Aliket LED 1500mm 50w matt optical continuous line Ligne continue



Includes driver, matt optical and LED Duris E5
Comprend driver, mat optique LED Duris E5

Initial module (MP), intermediate module (MI), final module (MF), closed module (MC)
Module initial (MP), module intermédiaire (MI), module final (MF), Module fermé (MC)

Ref.	Colour / Couleur	W	Lum.	Measu. / Mesures	€
037 01 4 50 2 84 MP	White/Blanc	50W	5512	1500x100,80x65,60	442,90
037 01 4 50 2 84 MI	White/Blanc	50W	5512	1500x100,80x65,60	442,90
037 01 4 50 2 84 MF	White/Blanc	50W	5512	1500x100,80x65,60	442,90
037 01 4 50 2 84 MC	White/Blanc	50W	5512	1500x100,80x65,60	442,90

* Standardly supplied with 4000° K LED lamp.
* En standard fourni avec lampe 4000° K LED.

Aliket LED 1500mm 50w asymmetric optical continuous line Ligne continue



Includes driver, asymmetric optical and LED Duris E5
Comprend driver, optique asymétrique LED Duris E5

Initial module (MP), intermediate module (MI), final module (MF), closed module (MC)
Module initial (MP), module intermédiaire (MI), module final (MF), Module fermé (MC)

Ref.	Colour / Couleur	W	Lum.	Measu. / Mesures	€
037 01 4 50 3 84 MP	White/Blanc	50W	5126	1500x100,80x65,60	510,60
037 01 4 50 3 84 MI	White/Blanc	50W	5126	1500x100,80x65,60	510,60
037 01 4 50 3 84 MF	White/Blanc	50W	5126	1500x100,80x65,60	510,60
037 01 4 50 3 84 MC	White/Blanc	50W	5126	1500x100,80x65,60	510,60

* Standardly supplied with 4000° K LED lamp.
* En standard fourni avec lampe 4000° K LED.

OPTIONS LED	Ref. 83	Ref. 84	Ref. 85	Ref. 85
CRI>80 / Colour temp./ Temp. de couleur	3000°K	4000°K	5000°K	5700°K
Lum 50w	5486	5512	-	5512
Lum 75w	7140	7386	7386	-



Aliket LED 1500mm 75w transparent optical continuous line
Ligne continue



Includes driver, transparent optical and LED Oslon SSL
Comprend driver, optique transparente LED Oslon SSL

Initial module (MP), intermediate module (MI), final module (MF), closed module (MC)
Module initial (MP), module intermédiaire (MI), module final (MF), Module fermé (MC)

Ref.	Colour / Couleur	W	Lum.	Measu. / Mesures	€
037 01 4 75 1 84 MP	White/Blanc	75W	7386	1500x100,80x65,60	489,80
037 01 4 75 1 84 MI	White/Blanc	75W	7386	1500x100,80x65,60	489,80
037 01 4 75 1 84 MF	White/Blanc	75W	7386	1500x100,80x65,60	489,80
037 01 4 75 1 84 MC	White/Blanc	75W	7386	1500x100,80x65,60	489,80

* Standardly supplied with 4000° K LED lamp.
* En standard fourni avec lampe 4000° K LED.

Aliket LED 1500mm 75w matt optical continuous line
Ligne continue



Includes driver, matt optical and LED Oslon SSL
Comprend driver, mat optique LED Oslon SSL

Initial module (MP), intermediate module (MI), final module (MF), closed module (MC)
Module initial (MP), module intermédiaire (MI), module final (MF), Module fermé (MC)

Ref.	Colour / Couleur	W	Lum.	Measu. / Mesures	€
037 01 4 75 2 84 MP	White/Blanc	75W	7386	1500x100,80x65,60	489,90
037 01 4 75 2 84 MI	White/Blanc	75W	7386	1500x100,80x65,60	489,90
037 01 4 75 2 84 MF	White/Blanc	75W	7386	1500x100,80x65,60	489,90
037 01 4 75 2 84 MC	White/Blanc	75W	7386	1500x100,80x65,60	489,90

* Standardly supplied with 4000° K LED lamp.
* En standard fourni avec lampe 4000° K LED.

Aliket LED 1500mm 75w asymmetric optical continuous line
Ligne continue



Includes driver, asymmetric optical and LED Oslon SSL
Comprend driver, optique asymétrique LED Oslon SSL

Initial module (MP), intermediate module (MI), final module (MF), closed module (MC)
Module initial (MP), module intermédiaire (MI), module final (MF), Module fermé (MC)

Ref.	Colour / Couleur	W	Lum.	Med. / Mesures	€
037 01 4 75 3 84 MP	White/Blanc	75W	6869	1500x100,80x65,60	559,60
037 01 4 75 3 84 MI	White/Blanc	75W	6869	1500x100,80x65,60	559,60
037 01 4 75 3 84 MF	White/Blanc	75W	6869	1500x100,80x65,60	559,60
037 01 4 75 3 84 MC	White/Blanc	75W	6869	1500x100,80x65,60	559,60

* Standardly supplied with 4000° K LED lamp.
* En standard fourni avec lampe 4000° K LED.

Rough price increase of accessories / Accessoires

Ref.	Description	50w	75w
Ref. DRD	Dimmable driver Dali / Driver Dimmable Dali	66,55	72,90
Ref. KE1	Emer. kit 1h. of autonomy / Kit d'urgence de 1 h. autonomie	116,20	116,20
Ref. KE3	Emer. kit 3h. of autonomy / Kit d'urgence de 3 h. autonomie	121,80	121,80
Ref. CRI90	CRI>90	35,00	38,00

Rough price increase of the finished frame / Augmentation châssis Terminer

Color other than white / Couleur autre que blanche	€
	31,00

Rough price increase of lamp / Icremento rapport à la lampe

Ref.	Description	50w	75w
Ref. LPF	LEDs Fish / Poisson - 4000K - CRI>90	25,00	28,00
Ref. LPB	LEDs Bread / Pain - 3000K - CRI>90	25,00	28,00
Ref. LCM	LEDs Meat / Viande - 2700K - CRI>90	25,00	28,00
Ref. LVV	LEDs Veg. and fruit / Légumes et fruits - 4000K - CRI>90	25,00	28,00

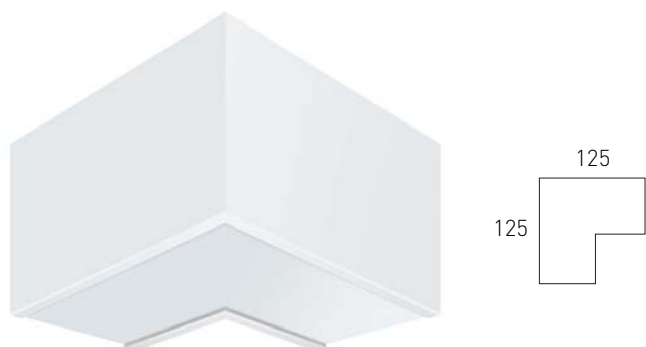

Aliket Led blind joint continuous line / Aliket LED coude aveugle ligne continue

Ref.	Colour / Couleur	Measu. / Mesures	€
0060 01 0	White/Blanc	125x125	175,90

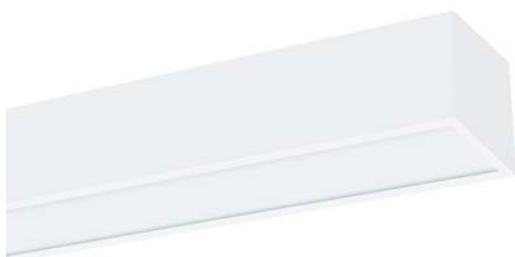

Aliket LED stretch blind / Aliket LED aveugle stretch

Ref.	Aliket	Stretch blind Aveugle stretch	€
0060	600mm	Initial module / Module initial MP	169,90
0061	600mm	Intermediate module / Module intermédiaire MI	169,90
0062	600mm	Final module / Module final MF	169,90
0120	1200mm	Initial module / Module initial MP	262,10
0121	1200mm	Intermediate module / Module intermédiaire MI	262,10
0122	1200mm	Final module / Module final MF	262,10
0150	1500mm	Initial module / Module initial MP	310,40
0151	1500mm	Intermediate module / Module intermédiaire MI	310,40
0152	1500mm	Final module / Module final MF	310,40

Aliket LED fixing for threaded rod M4 / Aliket LED fixation pour tige filetée M4

Ref.	Fixing / Fixation	Aliket	Units per luminaire Unids. per luminaire	€
FVR6	For hreaded rod / Pour tige filetée	600mm	2	9,00
FVR12	For hreaded rod / Pour tige filetée	1200mm	3	13,80
FVR15	For hreaded rod / Pour tige filetée	1500mm	3	13,80

Clamp surface / Surface de serrage

Ref.	€
0167	1,00



Aliket LED suspension kit / Aliket LED kit de suspension

Ref.	Aliket	Cable length Longueur du câble	Units per luminaire Unids. per luminaire	€
6001	600mm	1200mm	2	20,60
6002	600mm	2000mm	2	23,60
6003	600mm	3000mm	2	25,60
1201	1200mm	1200mm	3	30,90
1202	1200mm	2000mm	3	33,90
1203	1200mm	3000mm	3	36,90
1501	1500mm	1200mm	3	30,90
1502	1500mm	2000mm	3	33,90
1503	1500mm	3000mm	3	36,90

* Suspension available in other lengths (on request).

* Suspension disponible dans d'autres longueurs (sur demande).

Aliket LED fixing for chain 2x12mm / Aliket LED la chaîne de fixation 2x12mm

Ref.	Fixing / Fixation	Aliket	Units per luminaire Unids. per luminaire	€
FC6	For chain / Pour chaîne	600mm	2	11,00
FC12	For chain / Pour chaîne	1200mm	3	16,80
FC15	For chain / Pour chaîne	1500mm	3	16,80



Aliket LED kit chain 2x12mm / Aliket LED kit chaîne 2x12mm

Ref.	Aliket	Cable length Longueur du câble	Units per luminaire Unids. per luminaire	€
6004	600mm	1000mm	2	18,90
6005	600mm	2000mm	2	26,80
6006	600mm	3000mm	2	34,70
1204	1200mm	1000mm	3	24,40
1205	1200mm	2000mm	3	40,20
1206	1200mm	3000mm	3	49,90
1504	1500mm	1000mm	3	24,40
1505	1500mm	2000mm	3	40,20
1506	1500mm	3000mm	3	49,90

* Fixing available in other lengths (on request).

* Fixation disponible dans d'autres longueurs (sur demande).







Protek LED

Protection degree IP65 / Impact protection IK08

Protek LED is a light fixture that due to its elegant lines and its small size, it is perfectly integrated into any space, whether outside or inside business applications, such as industrial and street lightings.

With an outstanding output, the Protek LED is the result of the research and innovation of Secom Iluminacion.

This floodlight has the flexibility to adapt itself to any surface application, due to the homogeneity of light distribution and the high efficiency given by the latest technology of the semiconductors Osram Duris E5.

Made of die cast aluminum of 2.5mm thickness is provided with a IK10 polycarbonate closure, which allows an optimum passage of light. All these features give to the Protek LED a high robustness and resistance.

Totally versatile in its conception, it can be supplied with different powers, color temperatures (including RGBW controlled by DMX) and paint finishes.

Material:	Body made of injected aluminum, thermo painted.
Optics:	Optic included in the LED lamps. Includes waterproof polycarbonate protection with UV protection.
Supply:	Driver included for all models. Optionally supplied with RGBW driver controlled by DMX protocol, waterproof box separately (excluding joystick).
Lamps:	Osram Leds Module composed Duris E5 with 8/16/25/50W power. Ra (CRI) > 80 and available in three colour temperatures 3000°K, 4000°K and 5700°K. The RGBW module consists of 6 Osram Ostar LED Stage mixed colours, Red, Green, Blue and White (6500K) colour with a power of 50W.
Life span:	Estimated Average Life span 40.000 hours.
Installation:	Directly to wall or street furniture not (screws not included).
Colours:	White, black and gray.

Protek LED

IP65 de protection / Protection contre les chocs IK08

Protek LED est un luminaire qu'en raison de ses lignes élégantes et sa petite taille, est parfaitement intégré dans ne importe quel espace, soit à l'extérieur ou à l'intérieur d'affaires applications, telles que des éclairages industriels et de la rue.

Avec une sortie de point culminant, la LED Protek est le résultat de la recherche et l'innovation de Secom Iluminacion.

Ce projecteur a la souplesse nécessaire pour se adapter à ne importe quelle application de surface, en raison de l'homogénéité de répartition de la lumière et de la haute efficacité donnée par la dernière technologie des semi-conducteurs Osram Duris E5.

Fait de fonte d'aluminium de 2,5 mm d'épaisseur est pourvue d'un polycarbonate IK10 fermeture qui Allons un passage optimal de la lumière. Tout cela donne à l'Protek LED haute robustesse et de résistance.

Totalement polyvalent dans sa conception, il peut être fourni avec différentes puissances, températures de couleur (y compris RGBW contrôlée par DMX) et les finitions de peinture.

Matériel:	Corps en aluminium injecté, thermo peint.
Optique:	optique inclus dans les lampes à LED. Comprend polycarbonate étanche avec protection UV.
Alimentation:	Pilote inclus pour tous les modèles. Fourni en option avec chauffeur RGBW contrôlé par le protocole DMX, boîtier étanche séparément (hors joystick).
Lampes:	Osram module Leds composées Duris E5 avec 8/16 / 25 / 50W de puissance. Ra (CRI)> 80 et disponible en trois températures de couleur 3000°K, 4000°K et 5700°K. Le module de RGBW se compose de 6 couleurs OSTAR LED étape mélangés, Rouge, Vert, Bleu et Blanc (6500K) couleur avec une puissance de 50W.
Durée de vie estimée:	Durée de vie moyenne estimée 40,000 heures.
Installation:	Directement au mur ou au mobilier urbain non (vis non inclus).
Couleurs:	Blanc, noir et gris.

Protek LED



Includes protection polymer, driver and Leds lamps
Comprend polymère de protection, conducteur et lampes Leds

Ref.	Colour / Couleur	Lumens	W	€
4125 01 08 85	White / Blanc	1055	8w	115,60
4125 02 08 85	Black / Noir	1055	8w	117,20
4125 58 08 85	Gray / Gris	1055	8w	117,20
4125 01 16 85	White / Blanc	2110	16w	136,20
4125 02 16 85	Black / Noir	2110	16w	138,10
4125 58 16 85	Gray / Gris	2110	16w	138,10
4125 01 25 85	White / Blanc	3162	25w	141,84
4125 02 25 85	Black / Noir	3162	25w	143,20
4125 58 25 85	Gray / Gris	3162	25w	143,20
4125 01 50 85	White / Blanc	6332	50w	182,20
4125 02 50 85	Black / Noir	6332	50w	184,20
4125 58 50 85	Gray / Gris	6332	50w	184,20

* Standardly supplied with 5700° K LED lamp.

* En standard fourni avec lampe 5700° K LED.



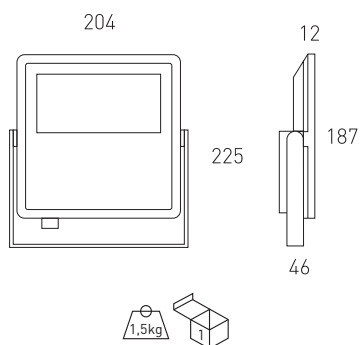

Video Installation
Vidéo d'installation

Rough price increase of accessories / Accessoires

		8w	16w	25w	50w
Ref. DRF	Dimmable driver edge phase / Driver réglable par coupure de phase	22,22	22,22	22,22	-
Ref. DR	Dimmable driver 1 - 10v / Driver Dimmable 1-10V	49,40	49,90	52,20	64,90
Ref. DRD	Dimmable driver Dali / Driver dimmable Dali	49,90	50,60	53,40	65,80
Ref. 4160	Driver for 12 Vdc operation / Driver pour 12 Vdc opération	42,90	42,90	42,90	-
Ref. 4160 24	Driver for 24 Vdc operation / Driver pour 24Vdc opération	42,90	42,90	42,90	-

OPTIONS LED

		Ref. 83	Ref. 84	Ref. 85
CRI>80 / Colour temperature / Température de couleur	W	3000°K	4000°K	5700°K
Lumens Osram Duris E5	8w	969	1055	1055
	16w	1939	2110	2110
	25w	2909	3162	3162
	50w	5818	6332	6332

Rough price increase of accessories / Accessoires

		€
Ref. 4131	Opal diffuser / Diffuseur opale	9,90
Ref. DM8	Motion detector integrated in the luminaire / Détecteur de mouvement intégré dans le lum.	56,00
Ref. AM	Special marine environment paint / Peinture spéciale pour environnement marin	30,00
Ref. MP	Telaio da incasso / Quadro recesso	67,10

Protek Q2 LED

Protection degree IP65 / Impact protection IK08

Protek Q2 LED is the result of combining design, research, innovation, efficiency and functionality, capable of satisfying a wide range of needs in the field of projection and illumination of large environments.

Thanks to its elegant line and compact dimensions, it is perfectly integrated into any space in commercial applications, indoor, outdoor, sport facilities, and industrial and street, creating a harmonious whole.

This projector has the perfect flexibility to fit any application surface, thanks to the homogeneity of light distribution and its high efficiency and ability to project different atmospheres, playing with different degrees of opening and symmetries, all attached to high performance that gives the last generation semiconductor Osram Oslon SSL.

Made of cast aluminum 3 mm thick, it is provided with a closure IK 08 polycarbonate, high luminance luminous flux, making it a fixture of great strength and endurance.

Flexibility is another feature, it can be supplied in different powers, color temperature, degrees of opening and paint finishes, with the possibility of settings upon order.

Material:	Body made of injected aluminum, thermo painted.
Optics:	Optic included in the LED lamps. Includes waterproof polycarbonate protection with UV protection.
Supply:	Driver included for all models. Can be supplied with dimmable driver 1-10V (DR) and double level dimmable (DN).
Lamps:	Module composed by Oslon SLL Osram LED with a total power of 100w, 150w and 200w. Standardly supplied with a temperature of 5700°k. It can be optionally supplied with temperatures of 3000°K and 4000°k. Colour rendering index superior than 80 (CRI> 80).
Life span:	Estimated Average Life span 50.000 hours.
Installation:	Directly to wall or street furniture not (screws no included).
Colours:	White, black and grey.

Protek Q2 optic LED 80° Protek Q2 optique LED 80°



Includes protection polymer, driver and Leds lamps
Comprend polymère de protection, conducteur et lampes Leds

Ref.	Colour / Couleur	Lumens	W	€
4330 01 60 85	White / Blanc	7350	60w	498,40
4330 02 60 85	Black / Noir	7350	60w	501,00
4330 58 60 85	Gray / Gris	7350	60w	501,00
4330 01 10 85	White / Blanc	11287	100w	543,20
4330 02 10 85	Black / Noir	11287	100w	545,80
4330 58 10 85	Gray / Gris	11287	100w	545,80
4330 01 15 85	White / Blanc	16800	150w	675,10
4330 02 15 85	Black / Noir	16800	150w	677,80
4330 58 15 85	Gray / Gris	16800	150w	677,80
4330 01 20 85	White / Blanc	22575	200w	842,90
4330 02 20 85	Black / Noir	22575	200w	844,90
4330 58 20 85	Gray / Gris	22575	200w	844,90

* Standardly supplied with 5000°K LED lamp. / En standard fourni avec lampe 5000° K LED.

* Standardly supplied with 80° optics. / En standard fourni avec optic 80°.

Protek Q2 LED

IP65 de protection / Protection contre les chocs IK08

Protek Q2 LED est le résultat de la combinaison conception, la recherche, l'innovation, l'efficacité et la fonctionnalité, capable de satisfaire un large éventail de besoins dans le domaine de la projection et l'éclairage de grands environnements.

Merci à sa ligne élégante et des dimensions compactes, il est parfaitement intégrée dans ne importe quel espace dans des applications commerciales, à l'intérieur, des installations en plein air, sport, et industrielle et de la rue, créant un ensemble harmonieux.

Ce projecteur possède une parfaite flexibilité pour se adapter à ne importe quelle surface d'application, grâce de l'homogénéité de répartition de la lumière et de son efficacité élevée et leur capacité à projeter des ambiances différentes, en jouant avec différents degrés d'ouverture et symétries, tous attachés à la haute performance qui donne la dernière génération semiconducteur Osram Oslon SSL.

En fonte d'aluminium de 3 mm d'épaisseur, il est pourvu d'une fermeture IK 08 polycarbonate, luminance élevée de flux lumineux, ce qui en fait un appareil d'une grandeforce et l'endurance.

La flexibilité est une autre caractéristique, il peut être fourni en différentes puissances, la couleur la température, des degrés d'ouverture et de peinture finitions, avec la possibilité de paramètres sur commande.

Matériel:	Corps en aluminium injecté, thermo peint.
Optique:	optique inclus dans les lampes à LED. Comprend polycarbonate étanche avec protection UV.
Alimentation:	Pilote inclus pour tous les modèles. Peut être fourni avec chauffeur dimmable 1-10V (DR) et dimmable double niveau (DN).
Lampes:	Module composé par Oslon SLL Osram LED avec une puissance totale de 100W, 150w et 200w. En standard fourni avec une température de 5700 ° K. il peut être fournie en option avec des températures de 3000 ° K et 4000 ° k. Colour indice de rendu supérieure de 80 (CRI> 80).
Durée de vie estimée:	Durée de vie moyenne estimée 50,000 heures.
Installation:	Directement au mur ou au mobilier urbain non (vis non inclus).
Couleurs:	Blanc, noir et gris.



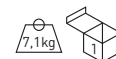
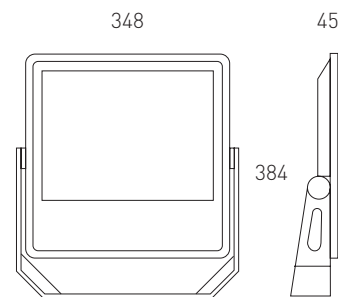
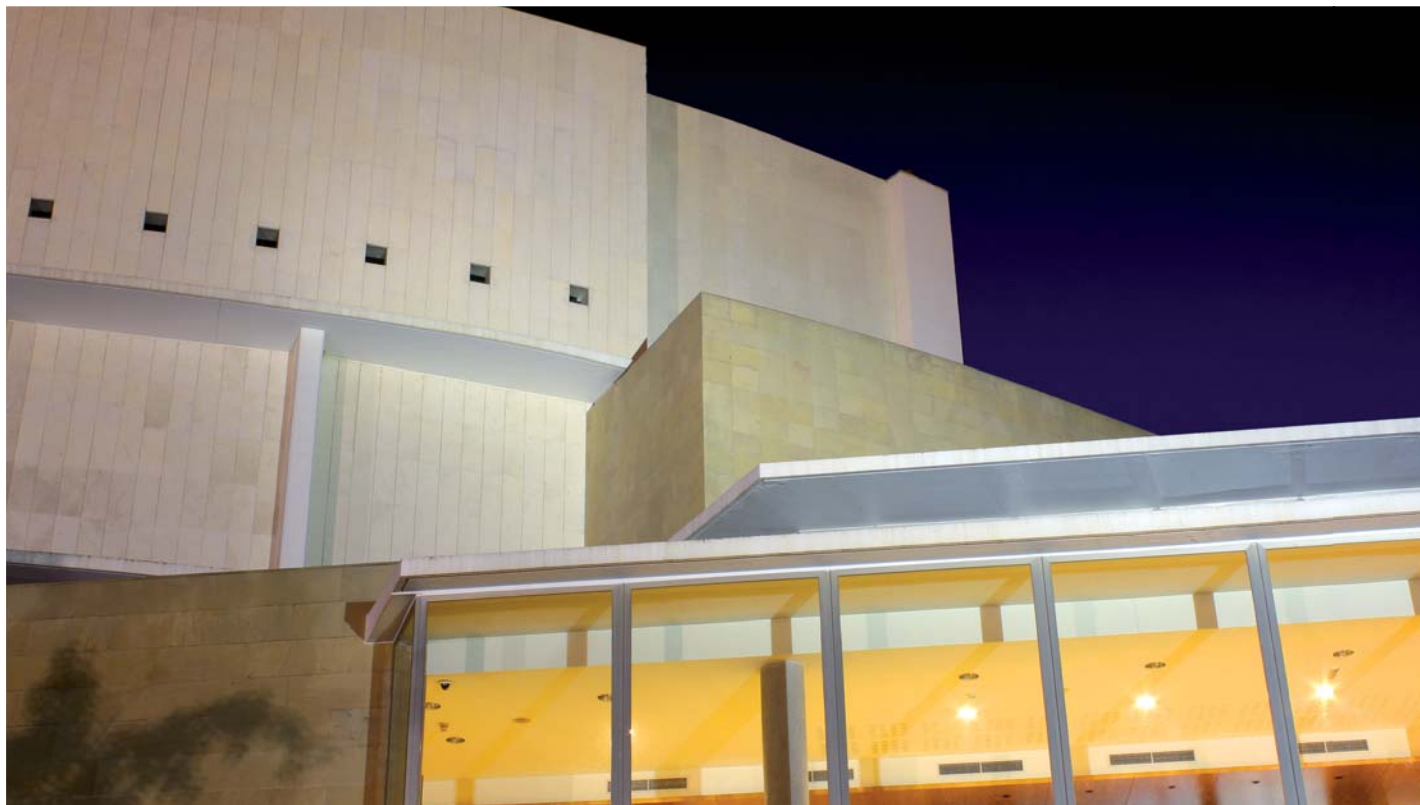

OPTIONS LED		Ref. AMB	Ref. 83	Ref. 84	Ref. 85
CRI>80 / Colour temp. / Temp. de couleur	W	Amber/Ambre	3000°K	4000°K	5000°K
Lumens Osram Oslon SSL	60w	5488	6860	7105	7350
	100w	8232	10535	10911	11287
	150w	12544	15680	16240	16800
	200w	17248	21070	21822	22575

Rough price increase of driver / Accessoires		€
Ref. DM8	Motion detector integrated in the luminaire / Détecteur de mouvement intégré dans le lum.	30,00
Rough price increase of accessories / Accessoires		€
Ref. AM	Special marine environment paint / Peinture spéciale pour environnement marin	70,00

Rough price increase of accessories / Accessoires		60w	100w	150w	200w
Ref. DR	Dimmable driver 1 - 10v / Driver dimmable 1-10V	51,50	51,50	176,60	243,20
Ref. DRD	Dimmable driver Dali / Driver dimmable Dali	64,80	64,80	182,40	268,50
Ref. DRP	Programmable driver / Driver programmable	94,80	94,80	183,50	288,50
Ref. 3407	LEDs with asymmetrical optics / LED avec optique asymétrique	98,60	98,60	162,20	199,60
Ref. 3409	LEDs with symmetric optics 48° / LEDs with symmetric optics 48°	72,24	72,24	112,60	140,00
Ref. 3421	LEDs with symmetric optics 150° / LED avec optique symétrique 150°	3,30	3,30	5,80	6,60
Ref. AMB	Amber LEDs / Ambre LEDs	39,80	79,60	119,40	159,20



Video Installation
Vidéo d'installation





Esdium Sport LED

Protection degree **IP66** / Impact protection index **IK08**

- Material:** Module and bracket made of thermo painted injected aluminum.
- Óptica:** LED modules include 100°, 50°, 41°, 32°, 21° and asymmetric 2 sides optics. TV broadcasting LED (5700°K CRI>90). Includes waterproof methacrylate (PMMA) with UV protection.
- Alimentación:** Driver with IP67 included for all models. Optionally supplied with 1-10V dimmable driver (Ref.-DR), Dali dimmable driver (Ref.-DRD) and programmable dimmable driver (Ref.-DRP).
- Lámparas:** Module composed by M or Mz Lumileds Luxeon LED with a total power of 150w, 300w, 450w, 600w, 750w and 900w. Available in 3000K, 4000K and 5000K. CRI>80.
- Vida útil:** Estimated Average Life span 50.000 hours.
- Protecciones:** The pcb incorporates safety diodes to protect and to guarantee his perfect functioning.
- Instalación:** Directly to wall, mast head frame or indoor catwalk (screws no included). Includes quick connector of 3 or 5 poles IP65.
- Temp. ambiente:** -20°C to 40°C.
- Colores:** Luminaire in gray. Opal diffuser closure. It can be supplied in other RAL colours by request.



Esdium Sport M1 - 150w - Horizontal - Optics 100° opening. Esdium Sport M1 - 150w - Horizontal - Optique 100° ouverture.

Includes driver and LED lamp / Comprend lampe LED et driver

Ref.	Colour / Couleur	Lumens	Module	W	€
6300 58 15 0 85	Gray / Gris	16560	M1 (1)	150w	684,90

* Standardly supplied with 5000°K LED lamp. / En standard fourni avec lampe 5000° K LED.
* Standardly supplied optics 100° opening. / En standard fourni avec optique 100° ouverture.

OPTIONS LED		Ref. 83	Ref. 84	Ref. 85
CRI>80 / Colour temperature / Température de couleur	W	3000°K	4000°K	5000°K
Lumens	150w	15300	16290	16560

Esdium Sport LED

Degré de protection **IP66** / Indice de protection anti-vandalismo **IK08**

- Matériel:** Module et le support, en thermolaqué aluminium injecté.
- Optique:** Modules LED comprennent 100°, 50°, 41°, 32°, 21° et asymétriques 2 côtés optique. Diffusion TV LED (5700°K CRI> 90). Comprend le méthacrylate étanche (PMMA) avec protection UV.
- Alimentation:** Driver avec IP67 inclus pour tous les modèles. Fourni en option avec 1-10V driver dimmable (Ref.- DR), Dali driver dimmable (Ref.- DRD) et le driver dimmable programmable (Ref.- DRP).
- Lampes:** Module composé par M ou Mz Lumileds Luxeon LED avec une puissance totale de 150W, 300w, 450w, 600w, 750w et 900w. Disponible en 3000K, 4000K et 5000K. CRI> 80.
- Durée de vie:** Moyenne estimée 50.000 heures.
- Protections:** Le pcb intègre des diodes de sécurité afin de protéger et de garantir son parfait fonctionnement.
- Installation:** Directement au mur, cadre de tête de mât ou passerelle intérieure (vis pas inclus). Comprend un raccord rapide de 3 ou 5 pôles IP65.
- Temp.:** -20°C à 40°C.
- Couleurs:** Luminaire en gris. Fermeture du diffuseur opale. Il peut être fourni dans d'autres couleurs RAL sur demande.

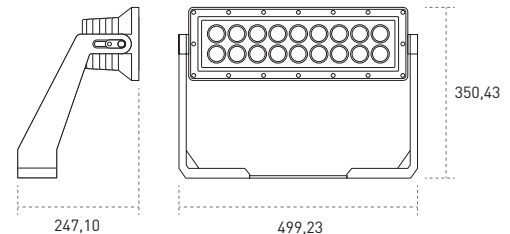

Esdium Sport LED M1 - Horizontal

Rough price increase of optics / Augmentation des prix pour l'optique		150w
Ref. 1	Extensive symmetric optics 41° / Optique symétrique extensifs 41°	79,38
Ref. 2	Medium symmetric optics 32° / Optique symétrique moyenne 32°	79,38
Ref. 3	Intensive symmetric optics 21° / Optique symétrique intensif 21°	79,38
Ref. 4	Frontal asymmetric optics 50° / Optique asymétrique Frontal 50°	94,50
Ref. 5	Asymmetric optic 2 sides 120° Lengthwise and 40° transversal Optiques Asymmetric 2 côtés 120° longueur et 40° transversal	94,50

Rough price increase of accessories / Accessoires		150w
Ref. DR	Dimmable driver 1 - 10v / Driver dimmable 1-10V	135,00
Ref. DRD	Dimmable driver Dali / Driver dimmable Dali	139,00
Ref. DRP	Programmable driver / Driver programmable	165,00
Ref. LTV	TV broadcasting LED (5700°K CRI>90) Diffusion TV LED (5700°K CRI>90)	42,90

Example to compose a reference with options
Exemple pour composer une référence avec des options

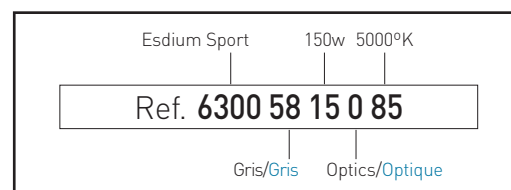

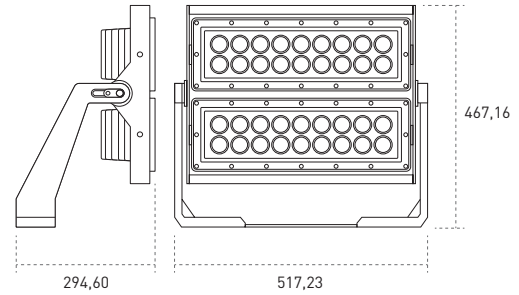

Esdium Sport LED M2 - Horizontal

Ref. 0

Optics 100° opening
Optique 100° ouverture

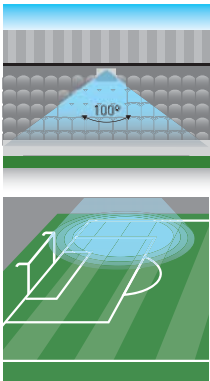

Ref. 1

Extensive symmetric optics 41°
Optique symétrique extensifs 41°

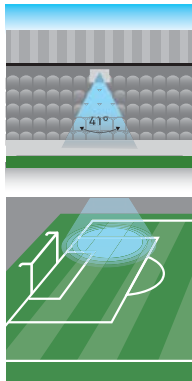

Ref. 2

Medium symmetric optics 32°
Optique symétrique moyenne 32°

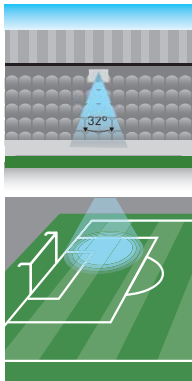

Ref. 3

Intensive symmetric optics 21°
Optique symétrique intensif 21°

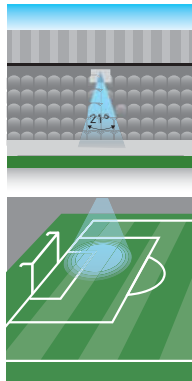

Ref. 4

Frontal asymmetric optics 50°
Optique asymétrique Frontal 50°

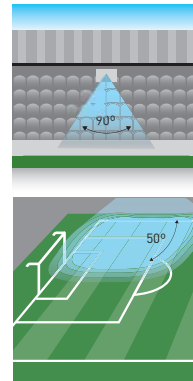

Ref. 5

Asymmetric optic 2 sides 120°
Lengthwise and 40° transversal
Optiques Asymmetric 2 côtés 120°
longueur et 40° transversal

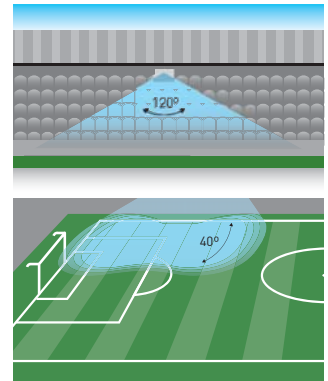

Esdium Sport M2 - 300w - Horizontal - Optics 100° opening.
Esdium Sport M2 - 300w - Horizontal - Optique 100° ouverture.



Includes driver and LED lamp / Comprend lampe LED et driver

Ref.	Colour / Couleur	Lumens	Module	W	€
6300 58 30 0 85	Gray / Gris	33120	M2 (2)	300w	1197,10

* Standardly supplied with 5000°K LED lamp. / En standard fourni avec lampe 5000° K LED.
* Standardly supplied optics 100° opening. / En standard fourni avec optique 100° ouverture.

OPTIONS LED		Ref. 83	Ref. 84	Ref. 85
CRI>80 / Colour temperature / Température de couleur	W	3000°K	4000°K	5000°K
Lumens	300w	30600	32580	33120

Rough price increase of optics / Augmentation des prix pour l'optique		300w
Ref. 1	Extensive symmetric optics 41° / Optique symétrique extensifs 41°	158,76
Ref. 2	Medium symmetric optics 32° / Optique symétrique moyenne 32°	158,76
Ref. 3	Intensive symmetric optics 21° / Optique symétrique intensif 21°	158,76
Ref. 4	Frontal asymmetric optics 50° / Optique asymétrique Frontal 50°	189,90
Ref. 5	Asymmetric optic 2 sides 120° Lengthwise and 40° transversal Optiques Asymmetric 2 côtés 120° longueur et 40° transversal	189,90

Rough price increase of accessories / Accessoires		300w
Ref. DR	Dimmable driver 1 - 10v / Driver dimmable 1-10V	270,00
Ref. DRD	Dimmable driver Dali / Driver dimmable Dali	278,00
Ref. DRP	Programmable driver / Driver programmable	330,00
Ref. LTV	TV broadcasting LED (5700°K CRI>90) Diffusion TV LED (5700°K CRI>90)	85,80

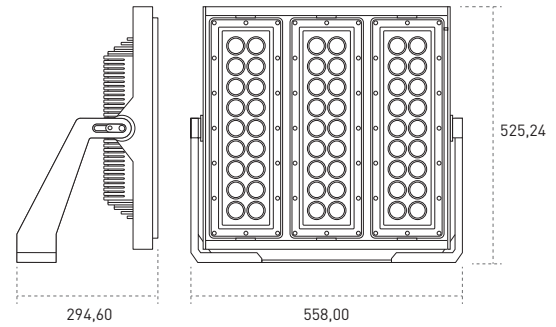
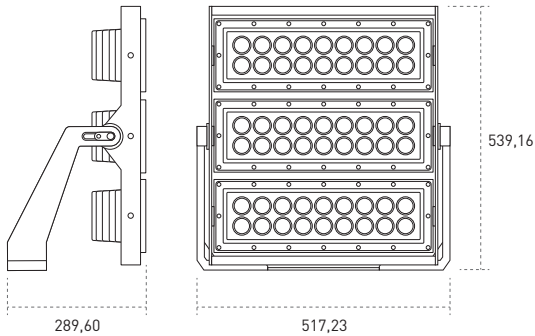

Esdium Sport LED M3 - Horizontal



Esdium Sport LED M3 - Vertical

Esdium Sport M3 - 450w - Horizontal - Optics 100° opening.
Esdium Sport M3 - 450w - Horizontal - Optique 100° ouverture.

Includes driver and LED lamp / Comprend lampe LED et driver

Ref.	Colour / Couleur	Lumens	Module	W	€
6300 58 45 0 85	Gray / Gris	49680	M3 (3)	450w	1888,38

* Standardly supplied with 5000°K LED lamp. / En standard fourni avec lampe 5000° K LED.
* Standardly supplied optics 100° opening. / En standard fourni avec optique 100° ouverture.

OPTIONS LED	Ref. 83	Ref. 84	Ref. 85	
CRI>80 / Colour temperature / Température de couleur	W	3000°K	4000°K	5000°K
Lumens	450w	45900	48870	49680

Rough price increase of accessories / Accessoires		450w
Ref. DR	Dimmable driver 1 - 10v / Driver dimmable 1-10V	405,00
Ref. DRD	Dimmable driver Dali / Driver dimmable Dali	417,00
Ref. DRP	Programmable driver / Driver programmable	495,00
Ref. LTV	TV broadcasting LED (5700°K CRI>90) Diffusion TV LED (5700°K CRI>90)	128,70

Esdium Sport M3 - 450w - Vertical - Optics 100° opening.
Esdium Sport M3 - 450w - vertical - Optique 100° ouverture.

Includes driver and LED lamp / Comprend lampe LED et driver

Ref.	Colour / Couleur	Lumens	Module	W	€
6301 58 45 0 85	Gray / Gris	49680	M3 (3)	450w	1888,38

* Standardly supplied with 5000°K LED lamp. / En standard fourni avec lampe 5000° K LED.
* Standardly supplied optics 100° opening. / En standard fourni avec optique 100° ouverture.

Rough price increase of optics / Augmentation des prix pour l'optique		450w
Ref. 1	Extensive symmetric optics 41° / Optique symétrique extensifs 41°	238,14
Ref. 2	Medium symmetric optics 32° / Optique symétrique moyenne 32°	238,14
Ref. 3	Intensive symmetric optics 21° / Optique symétrique intensif 21°	238,14
Ref. 4	Frontal asymmetric optics 50° / Optique asymétrique Frontal 50°	283,50
Ref. 5	Asymmetric optic 2 sides 120° Lengthwise and 40° transversal Optiques Asymmetric 2 côtés 120° longueur et 40° transversal	283,50

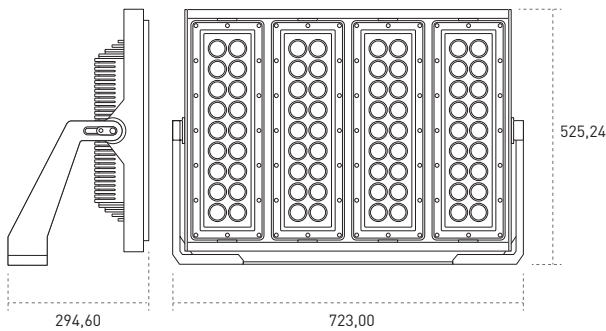

Esdium Sport LED M4 - Vertical



Ref. 0

Optics 100° opening
Optique 100° ouverture

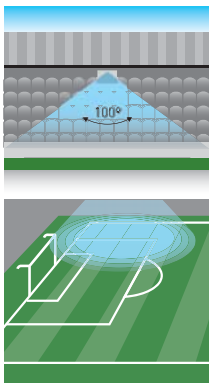

Ref. 1

Extensive symmetric optics 41°
Optique symétrique extensifs 41°

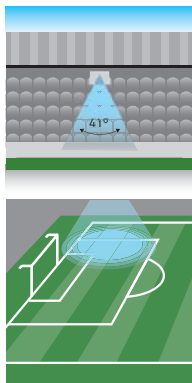

Ref. 2

Medium symmetric optics 32°
Optique symétrique moyenne 32°

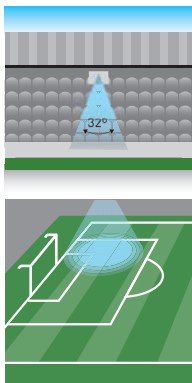

Ref. 3

Intensive symmetric optics 21°
Optique symétrique intensif 21°

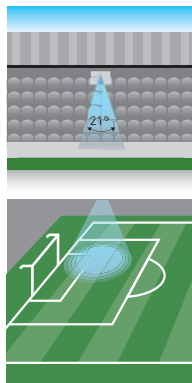

Ref. 4

Frontal asymmetric optics 50°
Optique asymétrique Frontal 50°

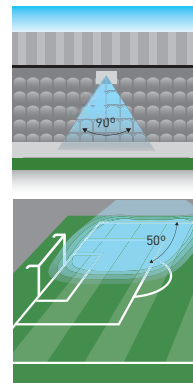

Ref. 5

Asymmetric optic 2 sides 120°
Lengthwise and 40° transversal
Optiques Asymmetric 2 côtés 120°
longueur et 40° transversal

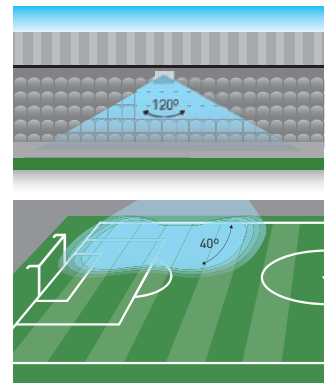

Esdium Sport M4 - 600w - Vertical - Optics 100° opening.
Esdium Sport M4 - 600w - vertical - Optique 100° ouverture.



Includes driver and LED lamp / Comprend lampe LED et driver

Ref.	Colour / Couleur	Lumens	Module	W	€
6301 58 60 0 85	Gray / Gris	66240	M4 (4)	600w	2560,44

* Standardly supplied with 5000°K LED lamp. / En standard fourni avec lampe 5000° K LED.
* Standardly supplied optics 100° opening. / En standard fourni avec optique 100° ouverture.

OPTIONS LED		Ref. 83	Ref. 84	Ref. 85
CRI>80 / Colour temperature / Température de couleur	W	3000°K	4000°K	5000°K
Lumens	600w	61200	65160	66240

Rough price increase of optics / Augmentation des prix pour l'optique		600w
Ref. 1	Extensive symmetric optics 41° / Optique symétrique extensifs 41°	317,52
Ref. 2	Medium symmetric optics 32° / Optique symétrique moyenne 32°	317,52
Ref. 3	Intensive symmetric optics 21° / Optique symétrique intensif 21°	317,52
Ref. 4	Frontal asymmetric optics 50° / Optique asymétrique Frontal 50°	378,00
Ref. 5	Asymmetric optic 2 sides 120° Lengthwise and 40° transversal Optiques Asymmetric 2 côtés 120° longueur et 40° transversal	378,00

Rough price increase of accessories / Accessoires		600w
Ref. DR	Dimmable driver 1 - 10v / Driver dimmable 1-10V	540,00
Ref. DRD	Dimmable driver Dali / Driver dimmable Dali	556,00
Ref. DRP	Programmable driver / Driver programmable	660,00
Ref. LTV	TV broadcasting LED (5700°K CRI>90) Diffusion TV LED (5700°K CRI>90)	171,60

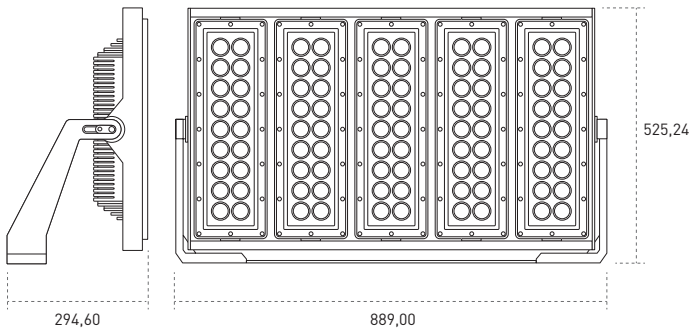

Esdium Sport LED M5 - Vertical

Esdium Sport M5 - 750w - Vertical - Optics 100° opening.
Esdium Sport M5 - 750w - vertical - Optique 100° ouverture.



Includes driver and LED lamp / Comprend lampe LED et driver

Ref.	Colour / Couleur	Lumens	Module	W	€
6301 58 75 0 85	Gray / Gris	82800	M5 (5)	750w	2996,70

* Standardly supplied with 5000°K LED lamp. / En standard fourni avec lampe 5000° K LED.
* Standardly supplied optics 100° opening. / En standard fourni avec optique 100° ouverture.

OPTIONS LED	Ref. 83	Ref. 84	Ref. 85
CRI>80 / Colour temperature / Température de couleur	3000°K	4000°K	5000°K
Lumens	750w	76500	81450
		82800	

Rough price increase of optics / Augmentation des prix pour l'optique		750w
Ref. 1	Extensive symmetric optics 41° / Optique symétrique extensifs 41°	396,90
Ref. 2	Medium symmetric optics 32° / Optique symétrique moyenne 32°	396,90
Ref. 3	Intensive symmetric optics 21° / Optique symétrique intensif 21°	396,60
Ref. 4	Frontal asymmetric optics 50° / Optique asymétrique Frontal 50°	472,50
Ref. 5	Asymmetric optic 2 sides 120° Lengthwise and 40° transversal Optiques Asymmetric 2 côtés 120° longueur et 40° transversal	472,50

Rough price increase of accessories / Accessoires		750w
Ref. DR	Dimmable driver 1 - 10v / Driver dimmable 1-10V	675,00
Ref. DRD	Dimmable driver Dali / Driver dimmable Dali	695,00
Ref. DRP	Programmable driver / Driver programmable	825,00
Ref. LTV	TV broadcasting LED (5700°K CRI>90) Diffusion TV LED (5700°K CRI>90)	214,50

Example to compose a reference with options
Exemple pour composer une référence avec des options

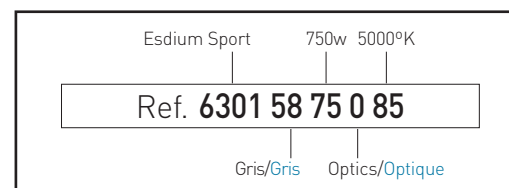

Ref. 0

Optics 100° opening
Optique 100° ouverture

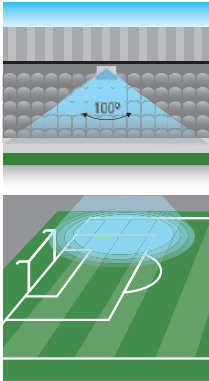

Ref. 1

Extensive symmetric optics 41°
Optique symétrique extensifs 41°

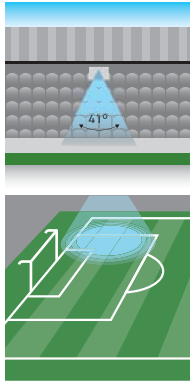

Ref. 2

Medium symmetric optics 32°
Optique symétrique moyenne 32°

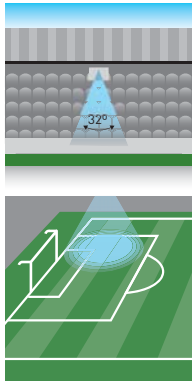

Ref. 3

Intensive symmetric optics 21°
Optique symétrique intensif 21°

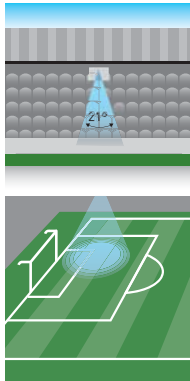

Ref. 4

Frontal asymmetric optics 50°
Optique asymétrique Frontal 50°

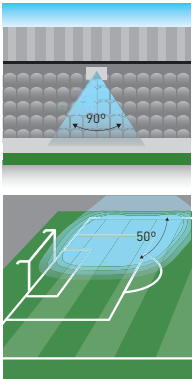

Ref. 5

Asymmetric optic 2 sides 120°
Lengthwise and 40° transversal
Optiques Asymmetric 2 côtés 120°
longueur et 40° transversal

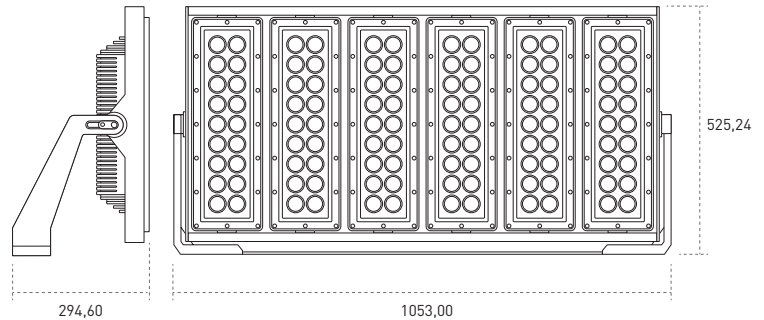
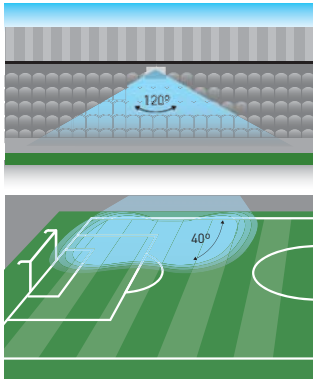

Esdium Sport LED M6 - Vertical

Esdium Sport M6 - 900w - Vertical - Optics 100° opening.
Esdium Sport M6 - 900w - vertical - Optique 100° ouverture.



Includes driver and LED lamp / Comprend lampe LED et driver

Ref.	Colour / Couleur	Lumens	Module	W	€
6301 58 90 0 85	Gray / Gris	99360	M6 (6)	900w	3850,10

* Standardly supplied with 5000°K LED lamp. / En standard fourni avec lampe 5000° K LED.
* Standardly supplied optics 100° opening. / En standard fourni avec optique 100° ouverture.

OPTIONS LED		Ref. 83	Ref. 84	Ref. 85
CRI>80 / Colour temperature / Température de couleur	W	3000°K	4000°K	5000°K
Lumens	900w	91800	97740	99360

Rough price increase of optics / Augmentation des prix pour l'optique		900w
Ref. 1	Extensive symmetric optics 41° / Optique symétrique extensifs 41°	476,28
Ref. 2	Medium symmetric optics 32° / Optique symétrique moyenne 32°	476,28
Ref. 3	Intensive symmetric optics 21° / Optique symétrique intensif 21°	476,28
Ref. 4	Frontal asymmetric optics 50° / Optique asymétrique Frontal 50°	567,00
Ref. 5	Asymmetric optic 2 sides 120° Lengthwise and 40° transversal Optiques Asymmetric 2 côtés 120° longueur et 40° transversal	567,00

Rough price increase of accessories / Accessoires		900w
Ref. DR	Dimmable driver 1 - 10v / Driver dimmable 1-10V	810,00
Ref. DRD	Dimmable driver Dali / Driver dimmable Dali	834,00
Ref. DRP	Programmable driver / Driver programmable	990,00
Ref. LTV	TV broadcasting LED [5700°K CRI>90] Diffusion TV LED [5700°K CRI>90]	257,40





Esdium Pro LED

Protection degree **IP66** / Impact protection index **IK08**

Material:	Module and bracket made of thermo painted injected aluminum.
Optics:	LED modules include 100°, 50°, 41°, 32°, 21° and asymmetric 2 sides optics. Includes waterproof methacrylate (PMMA) with UV protection.
Supply:	Driver with IP67 included for all models. Optionally supplied with 1-10V dimmable driver (Ref.-DR), Dali dimmable driver (Ref.-DRD) and programmable dimmable driver (Ref.-DRP).
Lamps:	Module composed by M or Mz Lumileds Luxeon LED with a total power of 150w, 300w, 450w, 600w, 750w and 900w. Available in 3000K, 4000K and 5000K. CRI>80.
Life span:	Estimated Average Life span 50.000 hours.
Protections:	The pcb incorporates safety diodes to protect and to guarantee his perfect functioning.
Installation:	Directly to wall or street furniture not (screws no included). Includes quick connector of 3 or 5 poles IP65.
Ambient temp.:	-20°C to 40°C.
Colours:	Luminaire in gray. Opal diffuser closure. It can be supplied in other RAL colours by request.



Esdium Pro LED

Degré de protection **IP66** / Indice de protection anti-vandalismo **IK08**

Matériel:	Module et le support, en thermolaqué aluminium injecté.
Optique:	Modules LED comprennent 100°, 50°, 41°, 32°, 21° et asymétriques 2 côtés optique. Comprend le méthacrylate étanche (PMMA) avec protection UV.
Alimentation:	Driver avec IP67 inclus pour tous les modèles. Fourni en option avec 1-10V driver dimmable (Ref.-DR), Dali driver dimmable (Ref.-DRD) et le driver dimmable programmable (Ref.-DRP).
Lampes:	Module composé par M ou Mz Lumileds Luxeon LED avec une puissance totale de 150W, 300w, 450w, 600w, 750w et 900w. Disponible en 3000K, 4000K et 5000K. CRI> 80.
Durée de vie:	Moyenne estimée 50.000 heures.
Protections:	Le pcb intègre des diodes de sécurité afin de protéger et de garantir son parfait fonctionnement.
Installation:	Directement au mur, cadre de tête de mât ou passerelle intérieure (vis pas inclus). Comprend un raccord rapide de 3 ou 5 pôles IP65.
Temp.:	-20°C à 40°C.
Couleurs:	Luminaire en gris. Fermeture du diffuseur opale. Il peut être fourni dans d'autres couleurs RAL sur demande.

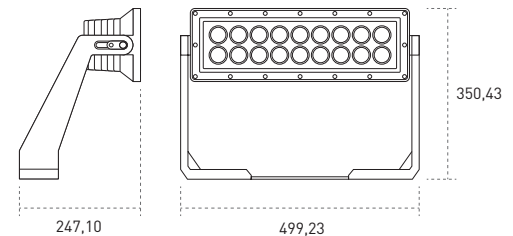

Esdium Pro LED M1 - Horizontal

Rough price increase of optics / Augmentation des prix pour l'optique		150w
Ref. 1	Extensive symmetric optics 41° / Optique symétrique extensifs 41°	79,38
Ref. 2	Medium symmetric optics 32° / Optique symétrique moyenne 32°	79,38
Ref. 3	Intensive symmetric optics 21° / Optique symétrique intensif 21°	79,38
Ref. 4	Frontal asymmetric optics 50° / Optique asymétrique Frontal 50°	94,50
Ref. 5	Asymmetric optic 2 sides 120° Lengthwise and 40° transversal Optiques Asymmetric 2 côtés 120° longueur et 40° transversal	94,50

Rough price increase of accessories / Accessoires		150w
Ref. DR	Dimmable driver 1 - 10v / Driver dimmable 1-10V	135,00
Ref. DRD	Dimmable driver Dali / Driver dimmable Dali	139,00
Ref. DRP	Programmable driver / Driver programmable	165,00

Esdium Pro M1 - 150w - Horizontal - Optics 100° opening. Esdium Pro M1 - 150w - Horizontal - Optique 100° ouverture.



Includes driver and LED lamp / Comprend lampe LED et driver

Ref.	Colour / Couleur	Lumens	Module	W	€
5300 58 15 0 85	Gray / Gris	16560	M1 (1)	150w	684,90

* Standardly supplied with 5000°K LED lamp. / En standard fourni avec lampe 5000° K LED.
* Standardly supplied optics 100° opening. / En standard fourni avec optique 100° ouverture.

OPTIONS LED		Ref. 83	Ref. 84	Ref. 85
CRi>80 / Colour temperature / Température de couleur	W	3000°K	4000°K	5000°K
Lumens	150w	15300	16290	16560

Example to compose a reference with options
Exemple pour composer une référence avec des options

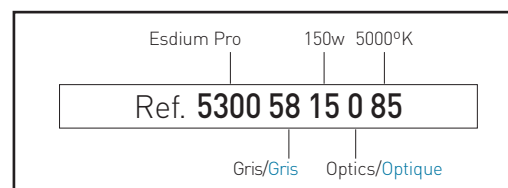

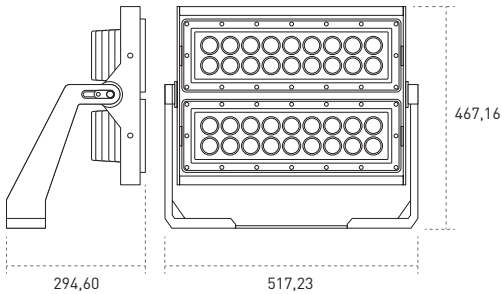

Esdium Pro LED M2 - Horizontal



Ref. 0

Optics 100° opening
Optique 100° ouverture

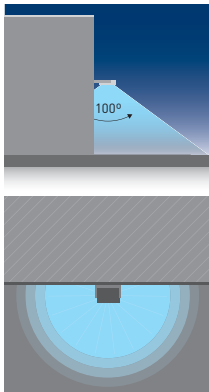

Ref. 1

Extensive symmetric optics 41°
Optique symétrique extensifs 41°

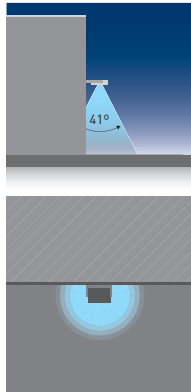

Ref. 2

Medium symmetric optics 32°
Optique symétrique moyenne 32°

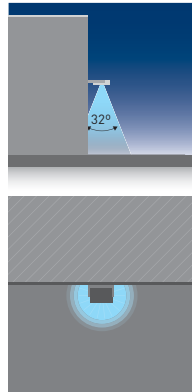

Ref. 3

Intensive symmetric optics 21°
Optique symétrique intensif 21°

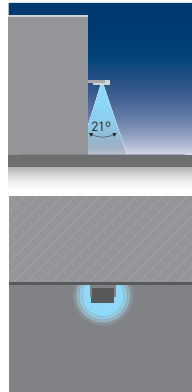

Ref. 4

Frontal asymmetric optics 50°
Optique asymétrique Frontal 50°

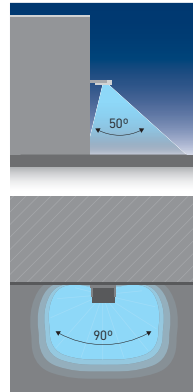

Ref. 5

Asymmetric optic 2 sides 120°
Lengthwise and 40° transversal
Optiques Asymmetric 2 côtés 120°
longueur et 40° transversal

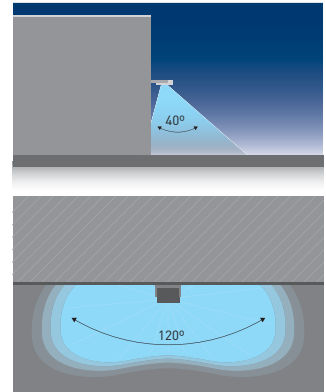

Esdium Pro M2 - 300w - Horizontal - Optics 100° opening.

Esdium Pro M2 - 300w - Horizontal - Optique 100° ouverture.



Includes driver and LED lamp / Comprend lampe LED et driver

Ref.	Colour / Couleur	Lumens	Module	W	€
5300 58 30 0 85	Gray / Gris	33120	M2 (2)	300w	1197,10

* Standardly supplied with 5000°K LED lamp. / En standard fourni avec lampe 5000° K LED.
* Standardly supplied optics 100° opening. / En standard fourni avec optique 100° ouverture.

OPTIONS LED		Ref. 83	Ref. 84	Ref. 85
CRI>80 / Colour temperature / Température de couleur	W	3000°K	4000°K	5000°K
Lumens	300w	30600	32580	33120

Rough price increase of optics / Augmentation des prix pour l'optique		300w
Ref. 1	Extensive symmetric optics 41° / Optique symétrique extensifs 41°	158,76
Ref. 2	Medium symmetric optics 32° / Optique symétrique moyenne 32°	158,76
Ref. 3	Intensive symmetric optics 21° / Optique symétrique intensif 21°	158,76
Ref. 4	Frontal asymmetric optics 50° / Optique asymétrique Frontal 50°	189,90
Ref. 5	Asymmetric optic 2 sides 120° Lengthwise and 40° transversal Optiques Asymmetric 2 côtés 120° longueur et 40° transversal	189,90

Rough price increase of accessories / Accessoires		300w
Ref. DR	Dimmable driver 1 - 10v / Driver dimmable 1-10V	270,00
Ref. DRD	Dimmable driver Dali / Driver dimmable Dali	278,00
Ref. DRP	Programmable driver / Driver programmable	330,00

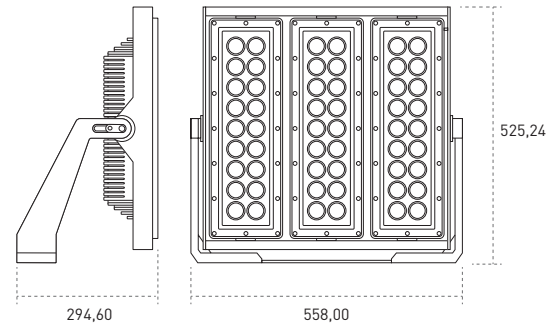
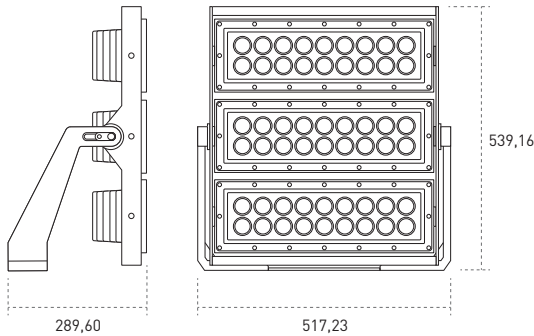

Esdium Pro LED M3 - Horizontal



Esdium Pro LED M3 - Vertical

Esdium Pro M3 - 450w - Horizontal - Optics 100° opening.
Esdium Pro M3 - 450w - Horizontal - Optique 100° ouverture.



Includes driver and LED lamp / Comprend lampe LED et driver

Ref.	Colour / Couleur	Lumens	Module	W	€
5300 58 45 0 85	Gray / Gris	49680	M3 (3)	450w	1888,38

* Standardly supplied with 5000°K LED lamp. / En standard fourni avec lampe 5000° K LED.
 * Standardly supplied optics 100° opening. / En standard fourni avec optique 100° ouverture.

OPTIONS LED		Ref. 83	Ref. 84	Ref. 85
CRI>80 / Colour temperature / Température de couleur	W	3000°K	4000°K	5000°K
Lumens	450w	45900	48870	49680

Rough price increase of accessories / Accessoires				450w
Ref. DR	Dimmable driver 1 - 10v / Driver dimmable 1-10V			405,00
Ref. DRD	Dimmable driver Dali / Driver dimmable Dali			417,00
Ref. DRP	Programmable driver / Driver programmable			495,00

Esdium Pro M3 - 450w - Vertical - Optics 100° opening.
Esdium Pro M3 - 450w - vertical - Optique 100° ouverture.



Includes driver and LED lamp / Comprend lampe LED et driver

Ref.	Colour / Couleur	Lumens	Module	W	€
5301 58 45 0 85	Gray / Gris	49680	M3 (3)	450w	1888,38

* Standardly supplied with 5000°K LED lamp. / En standard fourni avec lampe 5000° K LED.
 * Standardly supplied optics 100° opening. / En standard fourni avec optique 100° ouverture.

Rough price increase of optics / Augmentation des prix pour l'optique			450w
Ref. 1	Extensive symmetric optics 41° / Optique symétrique extensifs 41°		238,14
Ref. 2	Medium symmetric optics 32° / Optique symétrique moyenne 32°		238,14
Ref. 3	Intensive symmetric optics 21° / Optique symétrique intensif 21°		238,14
Ref. 4	Frontal asymmetric optics 50° / Optique asymétrique Frontal 50°		283,50
Ref. 5	Asymmetric optic 2 sides 120° Lengthwise and 40° transversal / Optiques Asymmetric 2 côtés 120° longueur et 40° transversal		283,50

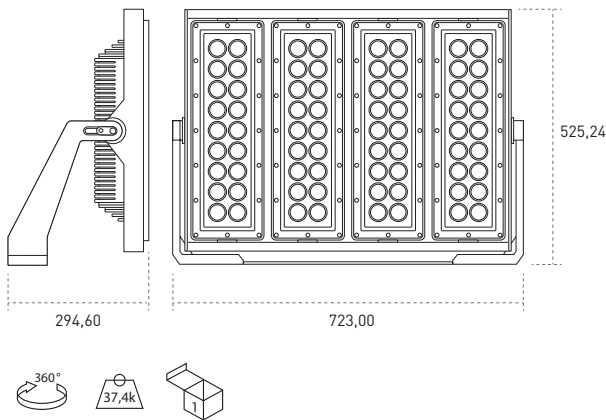

Esdium Pro LED M4 - Vertical



Ref. 0

Optics 100° opening
Optique 100° ouverture

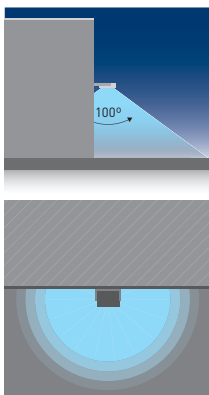

Ref. 1

Extensive symmetric optics 41°
Optique symétrique extensifs 41°

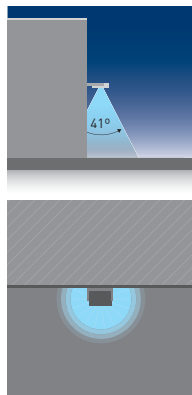

Ref. 2

Medium symmetric optics 32°
Optique symétrique moyenne 32°

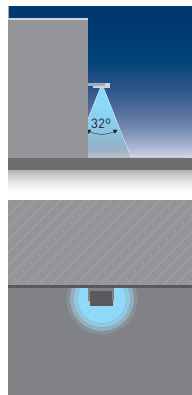

Ref. 3

Intensive symmetric optics 21°
Optique symétrique intensif 21°

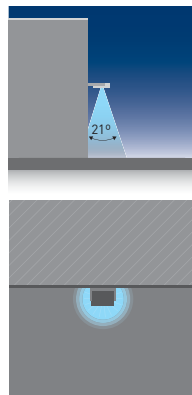

Ref. 4

Frontal asymmetric optics 50°
Optique asymétrique Frontal 50°

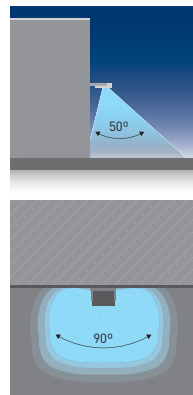

Ref. 5

Asymmetric optic 2 sides 120°
Lengthwise and 40° transversal
Optiques Asymmetric 2 côtés 120°
longueur et 40° transversal

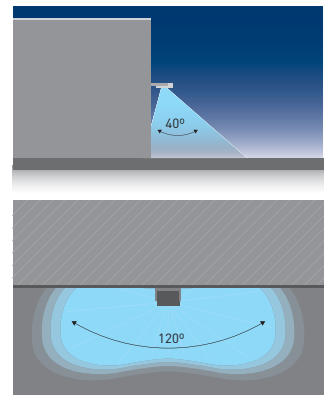

Esdium Pro M4 - 600w - Vertical - Optics 100° opening.
Esdium Pro M4 - 600w - vertical - Optique 100° ouverture.



Include driver y lámparas LEDs / Includes driver and LEDs lamp

Ref.	Colour / Couleur	Lumens	Module	W	€	RAEE lum.
5301 58 60 0 85	Gray / Gris	66240	M4 (4)	600w	2560,44	0,60

* Standardly supplied with 5000°K LED lamp. / En standard fourni avec lampe 5000° K LED.
* Standardly supplied optics 100° opening. / En standard fourni avec optique 100° ouverture.

OPTIONS LED		Ref. 83	Ref. 84	Ref. 85
CRI>80 / Colour temperature / Température de couleur	W	3000°K	4000°K	5000°K
Lumens	600w	61200	65160	66240

Rough price increase of optics / Augmentation des prix pour l'optique		600w
Ref. 1	Extensive symmetric optics 41° / Optique symétrique extensifs 41°	317,52
Ref. 2	Medium symmetric optics 32° / Optique symétrique moyenne 32°	317,52
Ref. 3	Intensive symmetric optics 21° / Optique symétrique intensif 21°	317,52
Ref. 4	Frontal asymmetric optics 50° / Optique asymétrique Frontal 50°	378,00
Ref. 5	Asymmetric optic 2 sides 120° Lengthwise and 40° transversal Optiques Asymmetric 2 côtés 120° longueur et 40° transversal	378,00

Rough price increase of accessories / Accessoires		600w
Ref. DR	Dimmable driver 1 - 10v / Driver dimmable 1-10V	540,00
Ref. DRD	Dimmable driver Dali / Driver dimmable Dali	556,00
Ref. DRP	Programmable driver / Driver programmable	660,00

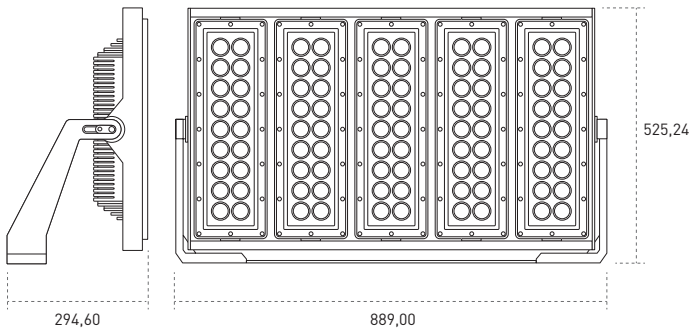

Esdium Pro LED M5 - Vertical

Esdium Pro M5 - 750w - Vertical - Optics 100° opening. Esdium Pro M5 - 750w - vertical - Optique 100° ouverture.



Includes driver and LED lamp / Comprend lampe LED et driver

Ref.	Colour / Couleur	Lumens	Module	W	€
5301 58 75 0 85	Gray / Gris	82800	M5 (5)	750w	2996,70

* Standardly supplied with 5000°K LED lamp. / En standard fourni avec lampe 5000° K LED.
* Standardly supplied optics 100° opening. / En standard fourni avec optique 100° ouverture.

OPTIONS LED		Ref. 83	Ref. 84	Ref. 85
CRI>80 / Colour temperature / Température de couleur	W	3000°K	4000°K	5000°K
Lumens	750w	76500	81450	82800

Rough price increase of optics / Augmentation des prix pour l'optique		750w
Ref. 1	Extensive symmetric optics 41° / Optique symétrique extensifs 41°	396,90
Ref. 2	Medium symmetric optics 32° / Optique symétrique moyenne 32°	396,90
Ref. 3	Intensive symmetric optics 21° / Optique symétrique intensif 21°	396,90
Ref. 4	Frontal asymmetric optics 50° / Optique asymétrique Frontal 50°	472,50
Ref. 5	Asymmetric optic 2 sides 120° Lengthwise and 40° transversal Optiques Asymmetric 2 côtés 120° longueur et 40° transversal	472,50

Rough price increase of accessories / Accessoires		750w
Ref. DR	Dimmable driver 1 - 10v / Driver dimmable 1-10V	675,00
Ref. DRD	Dimmable driver Dali / Driver dimmable Dali	695,00
Ref. DRP	Programmable driver / Driver programmable	825,00

Example to compose a reference with options
Exemple pour composer une référence avec des options

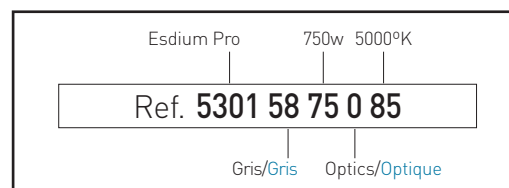

Ref. 0

Optics 100° opening
Optique 100° ouverture

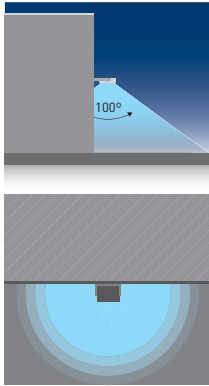

Ref. 1

Extensive symmetric optics 41°
Optique symétrique extensifs 41°

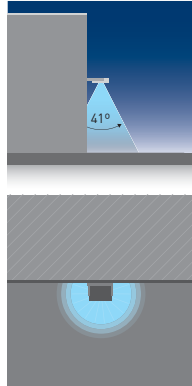

Ref. 2

Medium symmetric optics 32°
Optique symétrique moyenne 32°

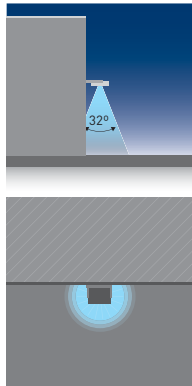

Ref. 3

Intensive symmetric optics 21°
Optique symétrique intensif 21°

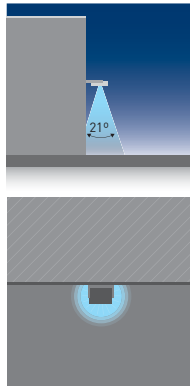

Ref. 4

Frontal asymmetric optics 50°
Optique asymétrique Frontal 50°

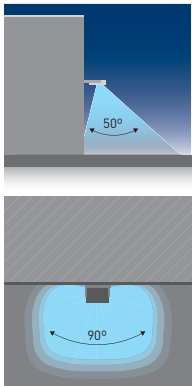

Ref. 5

Asymmetric optic 2 sides 120°
Lengthwise and 40° transversal
Optiques Asymmetric 2 côtés 120°
longueur et 40° transversal

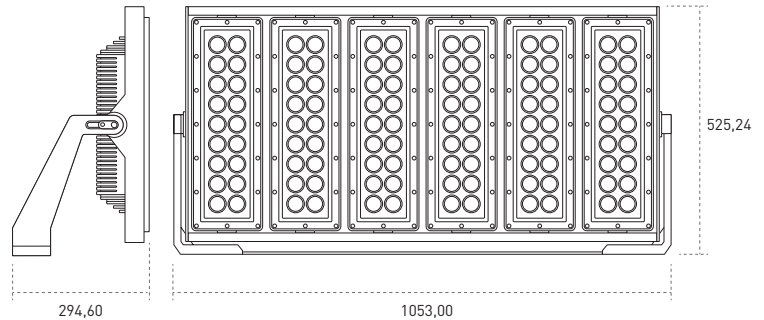
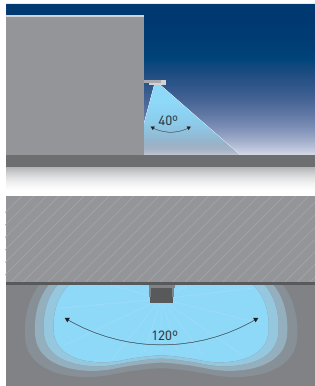

Esdium Pro LED M6 - Vertical

Esdium Pro M6 - 900w - Vertical - Optics 100° opening.
Esdium Pro M6 - 900w - vertical - Optique 100° ouverture.



Includes driver and LED lamp / Comprend lampe LED et driver

Ref.	Colour / Couleur	Lumens	Module	W	€
5301 58 90 0 85	Gray / Gris	99360	M6 (6)	900w	3850,10

* Standardly supplied with 5000°K LED lamp. / En standard fourni avec lampe 5000° K LED.
* Standardly supplied optics 100° opening. / En standard fourni avec optique 100° ouverture.

OPTIONS LED	Ref. 83	Ref. 84	Ref. 85
CRI>80 / Colour temperature / Température de couleur	3000°K	4000°K	5000°K
Lumens	900w	91800	97740
		97740	99360

Rough price increase of optics / Augmentation des prix pour l'optique		900w
Ref. 1	Extensive symmetric optics 41° / Optique symétrique extensifs 41°	476,28
Ref. 2	Medium symmetric optics 32° / Optique symétrique moyenne 32°	476,28
Ref. 3	Intensive symmetric optics 21° / Optique symétrique intensif 21°	476,28
Ref. 4	Frontal asymmetric optics 50° / Optique asymétrique Frontal 50°	567,00
Ref. 5	Asymmetric optic 2 sides 120° Lengthwise and 40° transversal Optiques Asymmetric 2 côtés 120° longueur et 40° transversal	567,00

Rough price increase of accessories / Accessoires		900w
Ref. DR	Dimmable driver 1 - 10v / Driver dimmable 1-10V	810,00
Ref. DRD	Dimmable driver Dali / Driver dimmable Dali	834,00
Ref. DRP	Programmable driver / Driver programmable	990,00





Esdium Tunnel LED

Protection degree **IP66** / Impact protection **IK08**

- Material:** Module and bracket made of thermo painted injected aluminum.
- Optics:** LED modules include asymmetric 2 sides, aerial symmetric and asymmetric Counter-beam optics. Includes waterproof methacrylate (PMMA) with UV protection.
- Supply:** Driver with IP67 included for all models. Optionally supplied with 1-10V dimmable driver (Ref.-DR), Dali dimmable driver (Ref.-DRD) and programmable dimmable driver (Ref.-DRP).
- Lamps:** Module composed by M or Mz Lumileds Luxeon LED with a total power of 150w and 300w. Available in 3000K, 4000K and 5000K. CRI>80.
- Life span:** Estimated Average Life span 50.000 hours.
- Protections:** The pcb incorporates safety diodes to protect and to guarantee his perfect functioning.
- Installation:** Directly to wall or ceiling (screws no included). Includes quick connector of 3 or 5 poles IP65.
- Ambient temp.:** -20°C to 40°C.
- Colours:** Luminaire in gray. Opal diffuser closure. It can be supplied in other RAL colours by request.

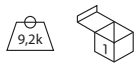
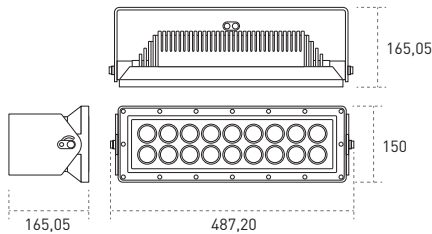

Esdium Tunnel LED M1 - Horizontal

Esdium Tunnel M1 - 150w - Horizontal - Asymmetric optics 2 sides

Esdium Tunnel M1 - 150w - Horizontal - Optique Asymmetric 2 côtés

Includes driver and LED lamp / **Comprend lampe LED et driver**

Ref.	Colour / Couleur	Lumens	Module	W	€
3300 58 15 5 85	Gray / Gris	16020	M1 (1)	150w	824,70

* Se suministra de manera estándar con LED 5000°K. / **Standardly supplied with 5000°K LED lamp.**

* Standardly supplied with asymmetric optic 2 sides 120° Lengthwise and 40° transversal.

En standard fourni avec optique asymétrique 2 côtés 120° longueur et 40° transversal.

OPTIONS LED	Ref. 83	Ref. 84	Ref. 85
CRI>80 / Colour temperature / Température de couleur	3000°K	4000°K	5000°K
Lumens	150w	14058	15840

Esdium Tunnel LED

Degré de protection **IP66** / Indice de protection anti-vandalismo **IK08**

- Matériel:** Module et le support, en thermolaqué aluminium injecté.
- Optique:** Modules LED comprennent asymétriques 2 côtés optique et Counter-beam asymétriques optiques. Diffusion TV LED (5700°K CRI> 90). Comprend le méthacrylate étanche (PMMA) avec protection UV.
- Alimentation:** Driver avec IP67 inclus pour tous les modèles. Fourni en option avec 1-10V driver dimmable (Ref.- DR), Dali driver dimmable (Ref.- DRD) et le driver dimmable programmable (Ref.- DRP).
- Lampes:** Module composé par M ou Mz Lumileds Luxeon LED avec une puissance totale de 150W et 300w. Disponible en 3000K, 4000K et 5000K. CRI> 80.
- Durée de vie:** Moyenne estimée 50.000 heures.
- Protections:** Le pcb intègre des diodes de sécurité afin de protéger et de garantir son parfait fonctionnement.
- Installation:** Directement au mur ou toit (aucun vis pas inclus). Comprend un raccord rapide de 3 ou 5 pôles IP65.
- Temp.:** -20°C à 40°C.
- Couleurs:** Luminaire en gris. Fermeture du diffuseur opale. Il peut être fourni dans d'autres couleurs RAL sur demande.



Rough price increase of optics / Augmentation des prix pour l'optique	150w
Ref. 6 Aerial asymmetric optic 140° lengthwise and 80° Cross Optique aérienne asymétrique 140° longueur et 80° Croix	18,90
Ref. 7 Asymmetric optics 50° Counter-beam / Optique asymétrique 50° Counter-faisceau	18,95

Rough price increase of accessories / Accessoires	150w
Ref. DR Dimmable driver 1 - 10v / Driver dimmable 1-10V	135,00
Ref. DRD Dimmable driver Dali / Driver dimmable Dali	139,00
Ref. DRP Programmable driver / Driver programmable	165,00

Example to compose a reference with options
Exemple pour composer une référence avec des options

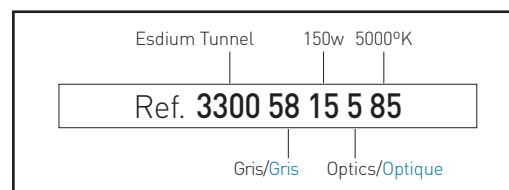

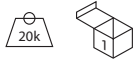
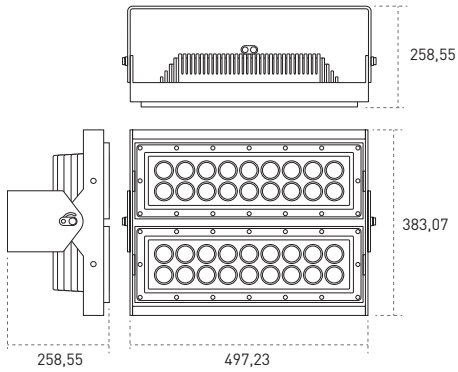

Esdium Tunnel LED M2- Horizontal



Ref. 5

Asymmetric optic 2 sides 120°
Lengthwise and 40° transversal
Optiques Asymétrique 2 côtés 120°
longueur et 40° transversal

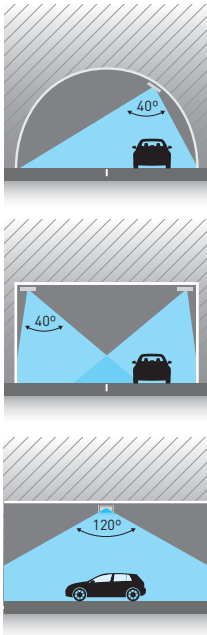

Ref. 6

Aerial asymmetric optic 140°
lengthwise and 80° Cross
Optique aérienne asymétrique
140° longueur et 80° Croix

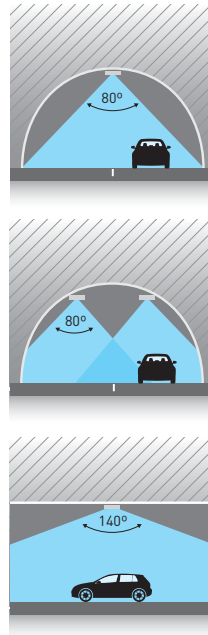

Ref. 7

Asymmetric optics 50°
Counter-beam
Optique asymétrique 50°
Counter-faisceau

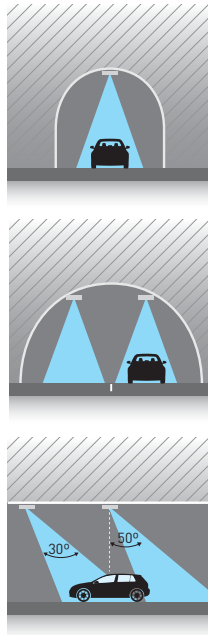

Esdium Tunnel M2 - 300w - Horizontal- Asymmetric optics 2 sides
Esdium Tunnel M2 - 300w - Horizontal - Optique Asymétrique 2 côtés

Includes driver and LED lamp / Comprend lampe LED et driver

Ref.	Colour / Couleur	Lumens	Module	W	€
3300 58 30 5 85	Gray / Gris	32040	M2 (2)	300w	1499,40

* Se suministra de manera estándar con LED 5000°K. / Standardly supplied with 5000°K LED lamp.
* Standardly supplied with asymmetric optic 2 sides 120° Lengthwise and 40° transversal.
En standard fourni avec optique asymétrique 2 côtés 120° longueur et 40° transversal.

OPTIONS LED		Ref. 83	Ref. 84	Ref. 85
CRI>80 / Colour temperature / Température de couleur	W	3000°K	4000°K	5000°K
Lumens	300w	28116	31680	32040

Rough price increase of optics / Augmentation des prix pour l'optique 300w

Ref. 6	Aerial asymmetric optic 140° lengthwise and 80° Cross Optique aérienne asymétrique 140° longueur et 80° Croix	37,80
Ref. 7	Asymmetric optics 50° Counter-beam / Optique asymétrique 50° Counter-faisceau	37,90

Rough price increase of accessories / Accessoires 300w

Ref. DR	Dimmable driver 1 - 10v / Driver dimmable 1-10V	270,00
Ref. DRD	Dimmable driver Dali / Driver dimmable Dali	278,00
Ref. DRP	Programmable driver / Driver programmable	330,00





Esdium Industrial LED

Protection degree **IP66** / Impact protection **IK08**

- Material:** Module and body made of thermo painted injected aluminum.
- Optics:** LED modules include 100°, 50°, 41°, 32°, 21° and asymmetric 2 sides optics. Includes waterproof methacrylate (PMMA) with UV protection.
- Supply:** Driver with IP67 included for all models. Optionally supplied with 1-10V dimmable driver (Ref.- DR), Dali dimmable driver (Ref.-DRD) and programmable dimmable driver (Ref.-DRP).
- Lamps:** Module composed by M or Mz Lumileds Luxeon LED with a total power of 150w, 300w, 450w and 600w. Available in 3000K, 4000K and 5000K. CRI>80.
- Life span:** Estimated Average Life span 50.000 hours.
- Protections:** The pcb incorporates safety diodes to protect and to guarantee his perfect functioning.
- Installation:** Directly hung up on ceiling by a suspension kit (Screw and suspension not included). Includes quick connector of 3 or 5 poles IP65.
- Ambient temp.:** -20°C to 40°C.
- Colours:** Luminaire in gray. Opal diffuser closure. It can be supplied in other RAL colours by request.



Esdium Pro M1 - 150w - Optics 100° opening. Esdium Pro M1 - 150w - Optique 100° ouverture.



Includes driver and LED lamp / Comprend lampe LED et driver

Ref.	Colour / Couleur	Lumens	Module	W	€
4400 58 15 0 85	Gray / Gris	16560	M1 (1)	150w	720,10

* Standardly supplied with 5000°K LED lamp. / En standard fourni avec lampe 5000° K LED.
* Standardly supplied optics 100° opening. / En standard fourni avec optique 100° ouverture.

OPTIONS LED		Ref. 83	Ref. 84	Ref. 85
CRI>80 / Colour temperature / Température de couleur	W	3000°K	4000°K	5000°K
Lumens	150w	15300	16290	16560

Esdium Industrial LED

Degré de protection **IP66** / Indice de protection anti-vandalismo **IK08**

- Matériel:** Module et le support, en thermolaqué aluminium injecté.
- Optique:** Modules LED comprennent 100°, 50°, 41°, 32°, 21° et asymétriques 2 côtés optique. Diffusion TV LED (5700°K CRI> 90). Comprend le méthacrylate étanche (PMMA) avec protection UV.
- Alimentation:** Driver avec IP67 inclus pour tous les modèles. Fourni en option avec 1-10V driver dimmable (Ref.- DR), Dali driver dimmable (Ref.- DRD) et le driver dimmable programmable (Ref.- DRP).
- Lampes:** Module composé par M ou Mz Lumileds Luxeon LED avec une puissance totale de 150W, 300w, 450w, 600w. Disponible en 3000K, 4000K et 5000K. CRI> 80.
- Durée de vie:** Moyenne estimée 50.000 heures.
- Protections:** Le pcb intègre des diodes de sécurité afin de protéger et de garantir son parfait fonctionnement.
- Installation:** Directement accroché au plafond par un kit de suspension (vis et suspension non inclus). Comprend un raccord rapide de 3 ou 5 pôles IP65.
- Temp.:** -20°C à 40°C.
- Couleurs:** Luminaire en gris. Fermeture du diffuseur opale. Il peut être fourni dans d'autres couleurs RAL sur demande.

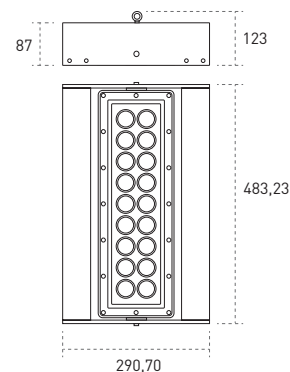

Esdium Industrial LED M1

Rough price increase of optics / Augmentation des prix pour l'optique		150w
Ref. 1	Extensive symmetric optics 41° / Optique symétrique extensifs 41°	79,38
Ref. 2	Medium symmetric optics 32° / Optique symétrique moyenne 32°	79,38
Ref. 3	Intensive symmetric optics 21° / Optique symétrique intensif 21°	79,38
Ref. 4	Frontal asymmetric optics 50° / Optique asymétrique Frontal 50°	94,50
Ref. 5	Asymmetric optic 2 sides 120° Lengthwise and 40° transversal Optiques Asymmetric 2 côtés 120° longueur et 40° transversal	94,50

Rough price increase of accessories / Accessoires		150w
Ref. DR	Dimmable driver 1 - 10v / Driver dimmable 1-10V	135,00
Ref. DRD	Dimmable driver Dali / Driver dimmable Dali	139,00
Ref. DRP	Programmable driver / Driver programmable	165,00

Example to compose a reference with options
Exemple pour composer une référence avec des options

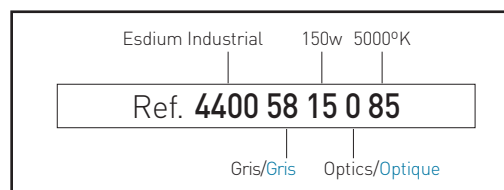

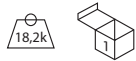
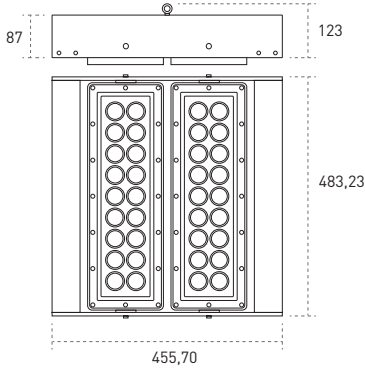

Esdium Industrial LED M2



Ref. 0

Optics 100° opening
Optique 100° ouverture

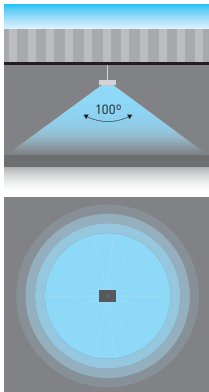

Ref. 1

Extensive symmetric optics 41°
Optique symétrique extensifs 41°

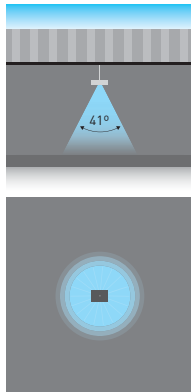

Ref. 2

Medium symmetric optics 32°
Optique symétrique moyenne 32°

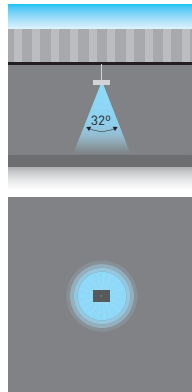

Ref. 3

Intensive symmetric optics 21°
Optique symétrique intensif 21°

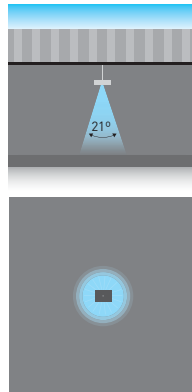

Ref. 4

Frontal asymmetric optics 50°
Optique asymétrique Frontal 50°

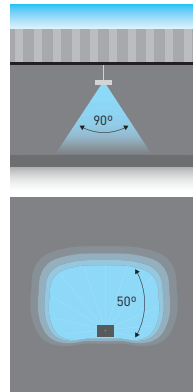

Ref. 5

Asymmetric optic 2 sides 120°
Lengthwise and 40° transversal
Optiques Asymmetric 2 côtés 120°
longueur et 40° transversal

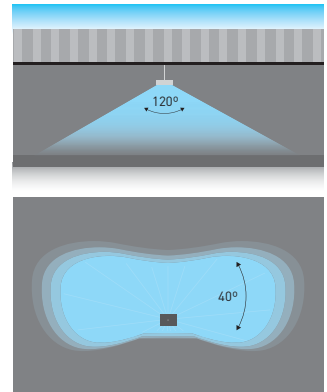

Esdium Pro M2 - 300w - Optics 100° opening.
Esdium Pro M2 - 300w - Optique 100° ouverture.



Includes driver and LED lamp / Comprend lampe LED et driver

Ref.	Colour / Couleur	Lumens	Module	W	€
4400 58 30 0 85	Gray / Gris	33120	M2 (2)	300w	1190,00

* Standardly supplied with 5000°K LED lamp. / En standard fourni avec lampe 5000° K LED.
* Standardly supplied optics 100° opening. / En standard fourni avec optique 100° ouverture.

OPTIONS LED	Ref. 83	Ref. 84	Ref. 85
CRI>80 / Colour temperature / Température de couleur	3000°K	4000°K	5000°K
Lumens	30600	32580	33120

Rough price increase of optics / Augmentation des prix pour l'optique	300w
Ref. 1 Extensive symmetric optics 41° / Optique symétrique extensifs 41°	158,76
Ref. 2 Medium symmetric optics 32° / Optique symétrique moyenne 32°	158,76
Ref. 3 Intensive symmetric optics 21° / Optique symétrique intensif 21°	158,76
Ref. 4 Frontal asymmetric optics 50° / Optique asymétrique Frontal 50°	189,90
Ref. 5 Asymmetric optic 2 sides 120° Lengthwise and 40° transversal Optiques Asymmetric 2 côtés 120° longueur et 40° transversal	189,90

Rough price increase of accessories / Accessoires	300w
Ref. DR Dimmable driver 1 - 10v / Driver dimmable 1-10V	270,00
Ref. DRD Dimmable driver Dali / Driver dimmable Dali	278,00
Ref. DRP Programmable driver / Driver programmable	330,00

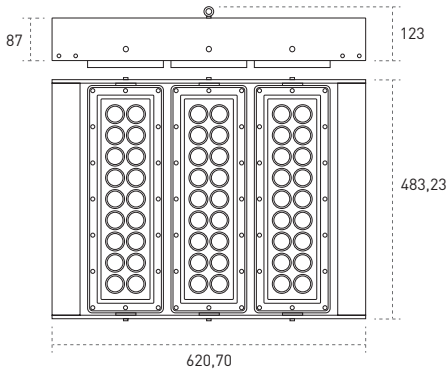

Esdium Industrial LED M3

Esdium Pro M3 - 450w - Optics 100° opening.
Esdium Pro M3 - 450w - Optique 100° ouverture.



Includes driver and LED lamp / **Comprend lampe LED et driver**

Ref.	Colour / Couleur	Lumens	Module	W	€
4400 58 45 0 85	Gray / Gris	49680	M3 (3)	450w	1725,20

* Standardly supplied with 5000°K LED lamp. / En standard fourni avec lampe 5000° K LED.
 * Standardly supplied optics 100° opening. / En standard fourni avec optique 100° ouverture.

OPTIONS LED		Ref. 83	Ref. 84	Ref. 85
CRI>80 / Colour temperature / Température de couleur	W	3000°K	4000°K	5000°K
Lumens	450w	45900	48870	49680

Rough price increase of optics / Augmentation des prix pour l'optique		450w
Ref. 1	Extensive symmetric optics 41° / Optique symétrique extensifs 41°	238,14
Ref. 2	Medium symmetric optics 32° / Optique symétrique moyenne 32°	238,14
Ref. 3	Intensive symmetric optics 21° / Optique symétrique intensif 21°	238,14
Ref. 4	Frontal asymmetric optics 50° / Optique asymétrique Frontal 50°	283,50
Ref. 5	Asymmetric optic 2 sides 120° Lengthwise and 40° transversal Optiques Asymmetric 2 côtés 120° longueur et 40° transversal	283,50

Rough price increase of accessories / Accessoires		450w
Ref. DR	Dimmable driver 1 - 10v / Driver dimmable 1-10V	405,00
Ref. DRD	Dimmable driver Dali / Driver dimmable Dali	417,00
Ref. DRP	Programmable driver / Driver programmable	495,00

Example to compose a reference with options
 Exemple pour composer une référence avec des options

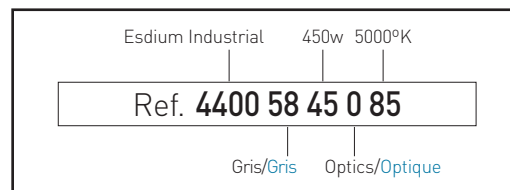

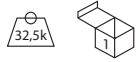
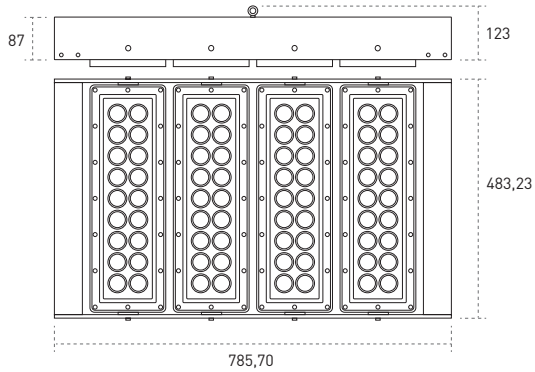

Esdium Industrial LED M4



Ref. 0

Optics 100° opening
Optique 100° ouverture

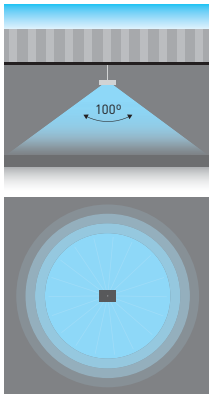

Ref. 1

Extensive symmetric optics 41°
Optique symétrique extensifs 41°

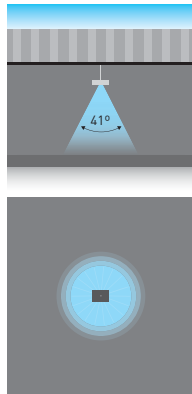

Ref. 2

Medium symmetric optics 32°
Optique symétrique moyenne 32°

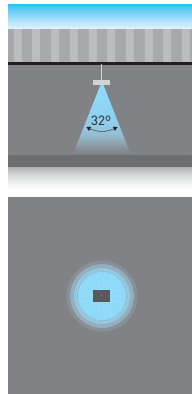

Ref. 3

Intensive symmetric optics 21°
Optique symétrique intensif 21°

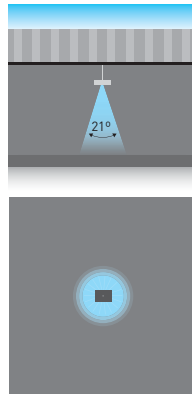

Ref. 4

Frontal asymmetric optics 50°
Optique asymétrique Frontal 50°

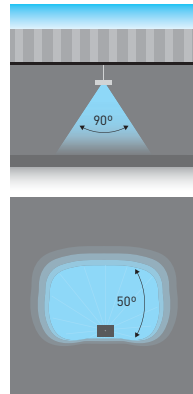

Ref. 5

Asymmetric optic 2 sides 120°
Lengthwise and 40° transversal
Optiques Asymmetric 2 côtés 120°
longueur et 40° transversal

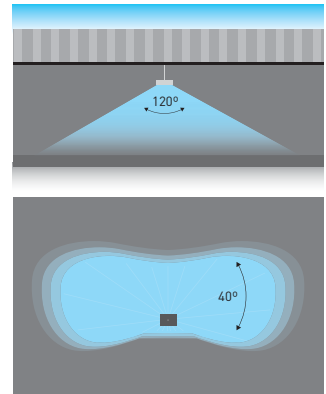

Esdium Pro M4- 600w - Optics 100° opening.
Esdium Pro M4 - 600w - Optique 100° ouverture.



Includes driver and LED lamp / Comprend lampe LED et driver

Ref.	Colour / Couleur	Lumens	Module	W	€
4400 58 60 0 85	Gray / Gris	66240	M4 (4)	600w	2295,12

* Standardly supplied with 5000°K LED lamp. / En standard fourni avec lampe 5000° K LED.
* Standardly supplied optics 100° opening. / En standard fourni avec optique 100° ouverture.

OPTIONS LED		Ref. 83	Ref. 84	Ref. 85
CRI>80 / Colour temperature / Température de couleur	W	3000°K	4000°K	5000°K
Lumens	600w	61200	65160	66240

Rough price increase of optics / Augmentation des prix pour l'optique		600w
Ref. 1	Extensive symmetric optics 41° / Optique symétrique extensifs 41°	317,52
Ref. 2	Medium symmetric optics 32° / Optique symétrique moyenne 32°	317,52
Ref. 3	Intensive symmetric optics 21° / Optique symétrique intensif 21°	317,52
Ref. 4	Frontal asymmetric optics 50° / Optique asymétrique Frontal 50°	378,00
Ref. 5	Asymmetric optic 2 sides 120° Lengthwise and 40° transversal Optiques Asymmetric 2 côtés 120° longueur et 40° transversal	378,00

Rough price increase of accessories / Accessoires		600w
Ref. DR	Dimmable driver 1 - 10v / Driver dimmable 1-10V	540,00
Ref. DRD	Dimmable driver Dali / Driver dimmable Dali	556,00
Ref. DRP	Programmable driver / Driver programmable	660,00





Esdium RGBW LED

Protection degree **IP66** / Impact protection **IK08**

- Material:** Module and bracket made of thermo painted injected aluminum.
- Optics:** LED module include RGBW optics. Includes waterproof methacrylate (PMMA) with UV protection.
- Supply:** Driver with IP67 included for all models. Optionally supplied with RGBW Controlle, wall recessed by DMX.
- Lamps:** Module composed by Oslon SSL LED with a total power of 95w, 190w and 285w. Available in 3000°K, 4000°K and 5000°K. CRI>80. Estimated Average Life span 50.000 hours.
- Life span:** Average Life span 50.000 hours.
- Protections:** The pcb incorporates safety diodes to protect and to guarantee his perfect functioning.
- Installation:** Directly to wall or street furniture not (screws no included). Includes quick connector of 3 or 5 poles IP65.
- Ambient temp.:** -20°C to 40°C.
- Colours:** Luminaire in gray. Opal diffuser closure. It can be supplied in other RAL colours by request.

Esdium RGBW LED

Degré de protection **IP66** / Indice de protection anti-vandalismo **IK08**

- Matériel:** Module et le support, en thermolaqué aluminium injecté.
- Optique:** Modules LED RGBW optique. Comprend le méthacrylate étanche (PMMA) avec protection UV.
- Alimentation:** Driver avec IP67 inclus pour tous les modèles. Fourni en option avec Contrôleur DMX encastré wall DMX.
- Lampes:** Module composé par Oslon SSL LED avec une puissance totale de 95W, 190w et 285w. Disponible en 3000K, 4000K et 5000K. CRI> 80.
- Durée de vie:** Moyenne estimée 50.000 heures.
- Protections:** Le pcb intègre des diodes de sécurité afin de protéger et de garantir son parfait fonctionnement.
- Installation:** Directement au mur, cadre de tête de mât ou passerelle intérieure (vis pas inclus). Comprend un raccord rapide de 3 ou 5 pôles IP65.
- Temp.:** -20°C à 40°C.
- Couleurs:** Luminaire en gris. Fermeture du diffuseur opale. Il peut être fourni dans d'autres couleurs RAL sur demande.

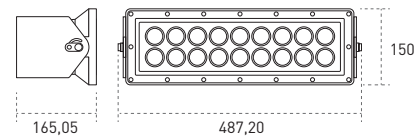

Esdium RGBW LED M1



Drivers box / Boîte drivers

Esdium RGBW M1 - 95w



Includes driver and LED lamp / Comprend lampe LED et driver

Ref.	Colour / Couleur	Lumens	Module	W	€
7300 58 95 0 85 RGBW	Gray / Gris	6136	M1 (1)	95w	1386,45

* Standardly supplied with 5000°K LED lamp. / En standard fourni avec lampe 5000° K LED.
* Standardly supplied optics 100° opening. / En standard fourni avec optique 100° ouverture.

OPTIONS LED		Ref. 83	Ref. 84	Ref. 85
CRI>80 / Colour temperature / Température de couleur	W	3000°K	4000°K	5000°K
LUMENS		6136	6136	6136

Rough price increase of optics / Augmentation des prix pour l'optique			95w
Ref. 8	Intensive symmetric optics 48° / Optique symétrique intensif 48°		178,80
Ref. 9	Symmetric optics 11° / Optique symétrique 11°		192,90

Rough price increase of accessories / Accessoires			95w
Ref. 4500	RGBW Controlle, wall recessed by DMX Contrôleur DMX encastré wall DMX		335,52



Drivers box / Boîte drivers

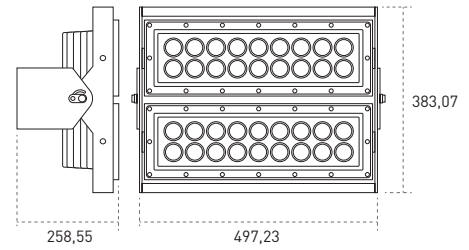

Esdium RGBW LED M2

Esdium RGBW M2 - 190w



Includes driver and LED lamp / Comprend lampe LED et driver

Ref.	Colour / Couleur	Lumens	Module	W	€
7300 58 19 0 85 RGBW	Gray / Gris	12272	M2 (2)	190w	2679,90

* Standardly supplied with 5000°K LED lamp. / En standard fourni avec lampe 5000° K LED.
* Standardly supplied optics 100° opening. / En standard fourni avec optique 100° ouverture.

OPTIONS LED	Ref. 83	Ref. 84	Ref. 85
CRI>80 / Colour temperature / Température de couleur	W 3000°K	4000°K	5000°K
LUMENS	190w 12272	12272	12272

Rough price increase of optics / Augmentation des prix pour l'optique	190w
Ref. 8 Intensive symmetric optics 48° / Optique symétrique intensif 48°	372,90
Ref. 9 Symmetric optics 11° / Optique symétrique 11°	398,60

Rough price increase of accesories / Accessoires	190w
Ref. 4500 Controllo remoto da incasso a parete RGBW DMX / Contrôleur DMX encastré wall DMX	335,52



Drivers box / Boîte drivers

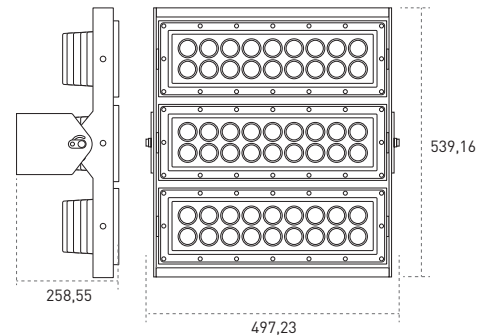

Esdium RGBW LED M3

Esdium RGBW M3 - 285w



Includes driver and LED lamp / Comprend lampe LED et driver

Ref.	Colour / Couleur	Lumens	Module	W	€
7300 58 28 0 85 RGBW	Gray / Gris	18408	M3 (3)	285w	3972,80

* Standardly supplied with 5000°K LED lamp. / En standard fourni avec lampe 5000° K LED.
* Standardly supplied optics 100° opening. / En standard fourni avec optique 100° ouverture.

OPTIONS LED	Ref. 83	Ref. 84	Ref. 85
CRI>80 / Colour temperature / Température de couleur	W 3000°K	4000°K	5000°K
LUMENS	285w 18408	18408	18408

Rough price increase of optics / Augmentation des prix pour l'optique	285w
Ref. 8 Intensive symmetric optics 48° / Optique symétrique intensif 48°	562,90
Ref. 9 Symmetric optics 11° / Optique symétrique 11°	594,60

Ricarico driver / Acrescimo em relação ao driver	285w
Ref. 4500 Controllo remoto da incasso a parete RGBW DMX / Contrôleur DMX encastré wall DMX	335,52





Konak LED

Protection degree IP65 / Impact protection IK08

Konak LED is a luminaire with an innovative design where the esthetic has been optimized for using it both high bay or flood light, getting a high performance in strength and reliability.

With a huge luminous efficiency because of its transparent polycarbonate closing, the body made in aluminum injection and the quality of the electronic components.

This luminaire has the great flexibility to adapt to any surface, with the possibility of been supplied in different powers: 40W, 100W, 150W, 200W and 250W; two different opening angle, 80° and 150° and different types of regulation allowing greater power saving.

Includes protection LEDs ensuring that the remaining string of LEDs keep working if one LED does not. The programmable version it is supplied with NTC sensor to protect the luminaire against occasional overtemperatures.

Material:	Body made of thermo painted injected aluminum.
Optics:	LED lamps include 80° optics. Includes waterproof polycarbonate with UV protection.
Supply:	Driver with IP67 included for all models. Optionally supplied with 1-10V dimmable driver (Ref.- DR), Dali dimmable driver (Ref.- DRD) or programmable dimmable driver (Ref.-DRP) and emergency kit for LED with 1h or 3h autonomy (KE1-KE3).
Lamps:	Module composed by Osram SLL Osram LED with a total power of 40w, 100w and 200w. Available in 3000K, 4000K and 5000K. CRI>80. Includes protector LED to increase the reliability.
Life span:	Estimated Average Life span 50.000 hours.
Protections:	The PCB board incorporates protector diodes to increase the reliability. The programmable version includes NTC sensor for protection against occasional overtemperature, reducing the working power or even turning off the luminaire.
Installation:	Directly hung up on ceiling by a suspension kit (Screw and suspension not included). Includes quick connector of 3 or 5 poles IP65.
Ambient temp.:	-20°C to 40°C.
Colours:	Luminaire in gray. Opal diffuser closure.



Konak LED

IP65 de protection / Protection contre les chocs IK08

Konak LED est un luminaire avec un design innovant où l'esthétique a été optimisée pour l'utilisation à la fois de grande hauteur ou une inondation de lumière, obtenir une haute performance de la force et de la fiabilité.

Avec une grande efficacité lumineuse en raison de sa polycarbonate transparent fermeture, le corps fabriqué en aluminium injecté et la qualité de l'électronique composants.

Ce luminaire a la grande flexibilité pour se adapter à ne importe quelle surface, avec la possibilité d'être fourni dans différentes puissances: 40W, 100W, 150W, 200W et 250W; deux différent angle d'ouverture, 80° et 150° et les différents types de régulation permettant une plus grande économie d'énergie.

Comprend des DEL de protection assurant que le reste de la chaîne de LED garder de travail si une LED ne est pas la version programmable il est fourni avec NTC pour protéger le luminaire contre occasionnelle sur des températures.

Matériel:	Corps en aluminium thermolaqué injecté.
Optique:	lampes LED comprennent 80° optique. Comprend polycarbonate étanche avec protection contre les UV.
Alimentation:	Conducteur avec IP67 inclus pour tous les modèles. Éventuellement fourni avec 1-10V conducteur dimmable (Ref.- DR), Dali pilote dimmable (Ref.- DRD) ou programmable conducteur dimmable (Ref.- DRP) et un kit d'urgence pour LED avec 1h ou 3h d'autonomie (KE1-KE3).
Lampes:	Module composé par Osram SLL Osram LED avec une puissance totale de 40W, 100w et 200w. Disponible en 3000K, 4000K et 5000K. CRI> 80. Comprend Protecteur LED pour augmenter la fiabilité.
Durée de vie estimée:	Durée de vie moyenne estimée 50,000 heures.
Protections:	Le platine incorpore diodes protecteurs pour augmenter la fiabilité. La version programmable comprend capteur NTC pour la protection contre overtemperature occasionnelle, ce qui réduit la puissance de travail ou même tourner extinction du luminaire.
Installation:	Directement raccroché au plafond par un kit de suspension (vis et suspension non inclus). Comprend connecteur rapide de 3 ou 5 pôles IP65.
Temp.:	-20 ° C à 40 ° C.
Couleurs:	Luminaire en gris. Fermeture du diffuseur opale.

Konak optic LED 80° Konak optique LED 80°



Includes driver and LEDs lamp / Comprend driver et lampes Leds

Ref.	Colour / Couleur	Lumens	W	€
4290 58 40 85	Gray / Gris	4725	40w	493,80
4290 58 10 85	Gray / Gris	11287	100w	512,70
4290 58 15 85	Gray / Gris	16800	150w	676,90
4290 58 20 85	Gray / Gris	22575	200w	799,80
4290 58 25 85	Gray / Gris	27562	250w	994,00

* Standardly supplied with 5000°K LED lamp. / En standard fourni avec lampe 5000° K LED.

* Standardly supplied with 80° optics. / En standard fourni avec optic 80°.

OPTIONS LED	Ref. 83	Ref. 84	Ref. 85	
CRI>80 / Colour temperature / Température de couleur	W	3000°K	4000°K	5000°K
Lumens Osram Osram SLL L	40w	4410	4567	4725
	100w	10535	10911	11287
	150w	15680	16240	16800
	200w	21070	21822	22575
	250w	25725	26643	27562

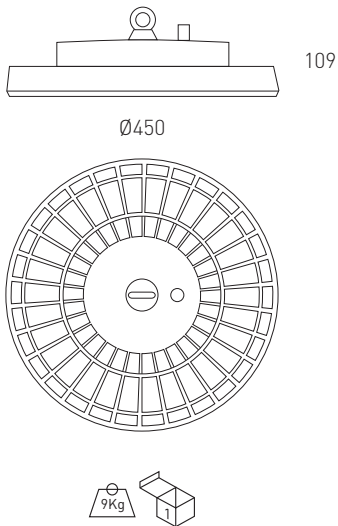

Video Installation
Vidéo d'installation



Rough price increase of accessories / Accessoires

		40w	100w	150w	200w	250w
Ref. DR	Dimmable driver 1 - 10v / Driver dimmable 1-10V	-	51,50	176,40	243,20	352,80
Ref. DRD	Dimmable driver Dali / Driver dimmable Dali	51,30	64,80	182,40	268,50	356,60
Ref. DRP	Programmable driver / Driver programmable	71,30	94,80	183,50	288,50	356,40
Ref. PCFT16	Control flow sensor and prsen. to 10 lum. DRD / Capteur de débit et de la prés. de 10 lum. DRD	268,90	268,90	268,90	268,90	268,90
Ref. KE1	Emergency Kit 1 hour of autonomy / Kit d'urgence de 1 heure d'autonomie	155,60	155,60	155,60	155,60	155,60
Ref. KE3	Emergency Kit 3 hours of autonomy / Kit d'urgence 3 heures d'autonomie	192,60	192,60	192,60	192,60	192,60
Ref. 3409	Leds with optics 48° / LED avec optique symétrique 48°	32,40	72,24	-	140,00	-
Ref. 3421	Leds with optics 150° / LED avec optique symétrique 150°	1,40	3,30	5,50	6,60	7,90
Ref. 4315	Opal diffuser / Diffuseur opale	12,90	12,90	12,90	12,90	12,90
Ref. DM8	Motion detector integrated in the luminaire / Détecteur de mouvement intégré dans le lum.	30,00	30,00	30,00	30,00	30,00





118

CASECO



2928 BML

Kloss LED waterproof screen

Protection degree IP65 / Impact protection IK09

Kloss LED, the waterproof screen of the future in the present.

LED Kloss is the result of combining design, functionality and efficiency as a new lighting concept for car parks, industrial facilities, and places that require a high degree of protection.

We present a compact luminaire equipped with the latest LED technology Duris E3 Osram, which together with its diffuser of PMMA (polymethyl - methacrylate), provides an excellent uniformity and visual comfort.

Kloss Led, luminaire made in injected polycarbonate with high strength and quality, stainless steel closure and accessories, which provide a high degree of protection and high level anti-vandal.

The simple installation system through brackets to ceiling or wall and IP65 power connector allows to work without manipulate the fitting. Also, the incorporation of an anti-theft system and its enormous resistance make it ideal for public lighting or industrial areas.

There are available different color temperatures, dimmable driver protocol DALI or 1-10V, and the option of sun sensors with automatic regulation.

Material:	Body made in polycarbonate.
Optics:	Polycarbonate opal diffuser with UV protection that provides a homogeneous light over the entire surface.
Supply:	All models include equipment. Optionally supplied with Dimmable 1-10V Driver , Dali Dimmable Driver, light control output / and LEDs emergency kit 1h or 3h .
Lamps:	PCB Module with Osram LED Duris E3 with a total power of 41W. CRI > 80 also available in 3000°K , 4000°K and 5700°K colour temperature.
Life span:	Estimated Average Life span 50.000 hours.
Installation:	Directly to ceiling with 2 stainless steel clips . They should be fixed to Ceiling with screws (not supplied). Also available with anti -vandal mounting option. Includes 2 quick electrical connectors with 3 or 5 poles to avoid the opening of the luminaire.
Security Light :	It offers the possibility of establishing a level of security lighting, with a continuous output of 10%, added to the presence control and regulation of the luminous flux (CFPS). This system controls up to 25 Dali Dimmable equipment (DRD).
Colours:	Luminaire in gray. Opal diffuser .

Kloss LED étanche

IP65 de protection / Protection contre les chocs IK09

Kloss LED, l'écran imperméable à l'eau de l'avenir dans le présent.

LED Kloss est le résultat de la combinaison design, la fonctionnalité et l'efficacité que un nouveau concept d'éclairage pour les parkings, les installations industrielles et les lieux qui nécessitent un degré élevé de protection.

Nous présentons un luminaire compact équipé de la dernière technologie LED Osram Duris E3, qui, avec son diffuseur de PMMA (polyméthyl - méthacrylate), fournit une excellente uniformité et le confort visuel.

Kloss Led, luminaire fait en polycarbonate injecté à haute résistance et qualité, de fermeture et accessoires en acier inoxydable, qui offrent un haut degré de protection et de haut niveau anti-vandalisme.

Le système d'installation simple grâce à crochets au plafond ou au mur et IP65 connecteur d'alimentation permet de travailler sans manipuler le raccord. En outre, l'incorporation d'un système anti-vol et son énorme résistance rendre idéal pour l'éclairage public ou les zones industrielles.

Il ya différentes températures de couleur disponibles, le protocole de pilote dimmable DALI ou 1-10V, et l'option de capteurs solaires à régulation automatique.

Matériel:	Corps en en polycarbonate.
Optique:	Diffuseur en polycarbonate opale avec protection UV qui offre une homogène éclairer sur toute la surface.
Alimentation:	Tous les modèles comprennent l'équipement. Éventuellement fourni avec Dimmable 1-10V pilote, Dali Dimmable pilote, la sortie de commande de lumière / LED et d'urgence 1h ou 3h kit.
Lampes:	Module de PCB avec LED Osram Duris E3 avec une puissance totale de 41W. CRI > 80 aussi disponible en 3000 ° K, 4000 ° K et 5700 ° K température de couleur.
Durée de vie estimée:	Durée de vie moyenne estimée 50,000 heures.
Installation:	Directement au plafond avec deux clips en acier inoxydable. Ils doivent être fixés à Plafond avec des vis (non fourni). Egalement disponible avec des anti -vandal option de montage. Comprend deux connecteurs électriques rapides avec 3 ou 5 poteaux pour éviter l'ouverture du luminaire.
Lampe de sécurité:	Il offre la possibilité d'établir un niveau d'éclairage de sécurité, avec un puissance continue de 10%, ajouté à la détection de présence et de la réglementation du flux lumineux (de PFC). Ce système permet de contrôler jusqu'à 25 Dali peut être obscurci équipements (DRD).
Couleurs:	Luminaire en gris. Diffuseur d'Opale.



Kloss waterproof lineal connection
Kloss étanche connexion linéaire



Includes 2 electrical connectors, driver and leds
Comprend 2 connecteurs électriques, driver et leds

Ref.	Colour / Couleur	Lumens	W	€
4100 58 20 84	Gray / Gris	2000	20w	169,40
4100 58 42 84	Gray / Gris	4000	42w	177,80
4100 58 60 84	Gray / Gris	6000	60w	226,40

* Standardly supplied with 4000° K LED lamp. / En standard fourni avec lampe 4000° K LED.

OPTIONS LED	Ref. 83	Ref. 84	Ref. 85
CRI>80 / Colour temperature / Température de couleur	3000°K	4000°K	5700°K
Lum 20w	1900	2000	2100
Lum 42w	3800	4000	4200
Lum 60w	5700	6000	6300

Kloss waterproof separate connection
Kloss étanche connexion séparée



Includes 1 electrical connector, 1 stopper, driver and leds
Comprend 1 connecteur électrique, 1 bouchon, driver et leds

Ref.	Colour / Couleur	Lumens	W	€
4110 58 20 84	Gray / Gris	2000	20w	168,20
4110 58 42 84	Gray / Gris	4000	42w	176,80
4110 58 60 84	Gray / Gris	6000	60w	223,90

* Standardly supplied with 4000° K LED lamp. / En standard fourni avec lampe 4000° K LED.



Video Installation
Vidéo d'installation

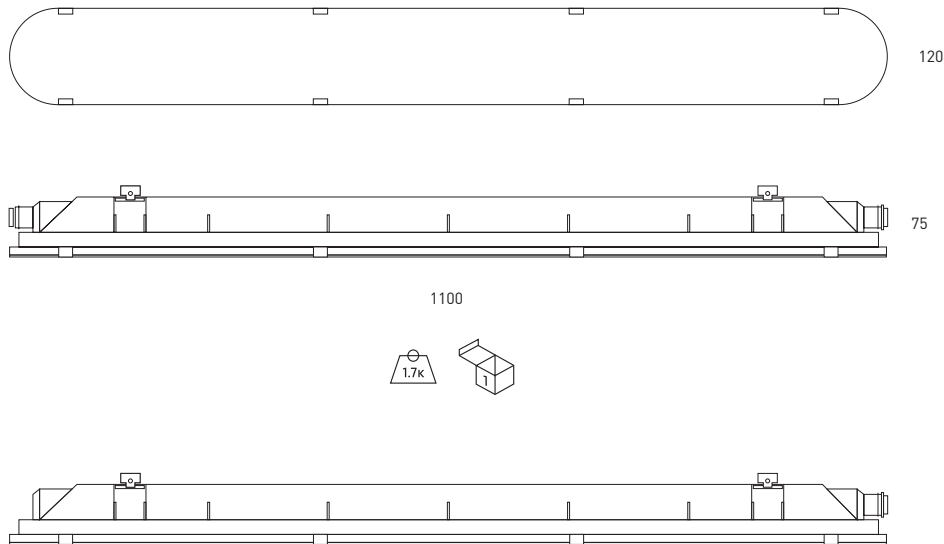

Conexión independiente / Separate connection



Ref. **CFPS**
Lighting control and sensor system
Ligting contrôle et le capteur sytem

Rough price increase of accesories / Accessoires

Ref.	Description	20/40w	60w
Ref. DR	Dimmable driver 1 - 10v / Driver dimmable 1-10V	79,20	90,10
Ref. DRD	Dimmable driver Dali / Dimmable driver Dali	79,82	90,80
Ref. CFPS	Flux control, sensor of light and presence and the possib. of 10% security lighting Contrôle du flux, capteur de lumière et la présence et la possibilité de l'éclairage de sécurité de 10%	216,90	216,90
Ref. CN20	Connector for 20 mm PVC tube / Connecteur pour 20 mm tube de PVC	1,50	1,50
Ref. FA	Anti vandal fixing / Fixation anti-vandalisme	24,40	24,40
Ref. KE1	Emergency Kit 1 hour of autonomy / Kit d'urgence de 1 heure d'autonomie	136,80	136,80
Ref. KE3	Emergency Kit 3 hours of autonomy / Kit d'urgence 3 heures d'autonomie	151,80	151,80
Ref. TPK	Sealing cap for separate connection / Bouchon d'étanchéité pour connexion séparée	1,00	1,00
Ref. DM8	Motion detector integrated in the luminaire / Détecteur de mouvement intégré dans le lum.	30,00	30,00



Berna Eco LED

Protection degree **IP65** / Impact protection **IK08**

Material: Body made in polycarbonate.
Optics: Prismatic diffuser made in polycarbonate.
Supply: All models include control gear and lamps.
Lamps: It uses Osram LEDs Duris E5. Optionally with 3000°k, 4000°k or 5700°k.
Installation: Directly to ceiling with bolts (not supplied).
Colours: Luminaire body made in grey. Diffuser matt.

Berna Eco LED

Degré de protection **IP65** / Indice de protection anti-vandalisme **IK08**

Matériel: Corps en en polycarbonate.
Optique: Diffuseur en polycarbonate opale.
Alimentation: Tous les modèles comprennent l'équipement.
Lampes: Module de PCB avec LED Osram Duris E5. Disponible en 3000 ° K, 4000 ° K et 5700 ° K
Installation: Directement au plafond avec des boulonnerie (non fourni).
Couleurs: Luminaire en gris. Diffuseur d'Opale.

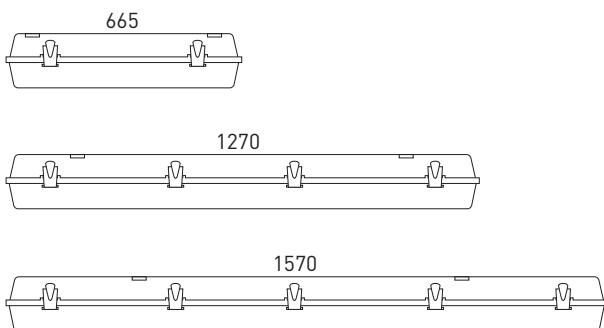

Berna Eco LED waterproof / Berna Eco LED étanche

Includes driver and LEDs lamp
Comprend driver et lampes Leds

Ref.	Colour / Couleur	Measu. / Mesures	Lumens	W	€	RAEE lum.
907 20 85	Gris / Gray	665x100	3047	20w	79,52	0,10
907 40 85	Gris / Gray	1270x100	6094	40w	109,52	0,10
907 60 85	Gris / Gray	1570x100	8802	60w	137,64	0,10

* Standardly supplied with 4000° K LED lamp. / En standard fourni avec lampe 4000° K LED.

OPTIONS LED	Ref. 83	Ref. 84	Ref. 85
CRI>80 / Colour temperature / Température de couleur	3000°K	4000°K	5700°K
Lum 20w	2776	2894	3047
Lum 40w	5552	5788	6094
Lum 60w	8020	8631	8802

Incremento respecto al driver / Rough price increase of accessories	20/40w	60w
Ref. DR Dimmable driver 1 - 10v / Driver dimmable 1-10V	79,20	90,10
Ref. DRD Dimmable driver Dali / Dimmable driver Dali	79,82	90,80
Ref. KE1 Emergency Kit 1 h. of autonomy / Kit d'urgence de 1 h. d'autonomie	136,80	136,80
Ref. KE3 Emergency Kit 3 h. of autonomy / Kit d'urgence 3 h. d'autonomie	151,80	151,80



Flopro Z1 / Z2 / Z3 LED - Recessed floor

Protection degree IP67 / IK10

- Material:** Finished in stainless steel 316. Body of the luminaire made in injected plastic in Z1, injected aluminium in Z2 and Z3. It has an auxiliary box for recessed in building site. It includes a protection tempered glass which have 5000kg resistance.
- Óptica:** Integrated in the lamps, with opening angles of 120° for Z1 and 48 ° or 11 ° for Z2 and Z3.
- Supply:** All models include control gear and lamps.
- Lamps:** LEDs Osram, Duris E5 for Z1 and Oslon SSL for Z2 / Z3.
- Installation:** Floor installation by auxiliary box recessed in concrete work, not used directly on the ground or grass.
- Colours:** Stainless steel.

Flopro Z1 / Z2 / Z3 LED - Encastré de sol

Degré de protection IP67 / IK10

- Matériel:** Fini en acier inoxydable 316. Corps du luminaire fabriqué en plastique injecté dans Z1, aluminium injecté dans Z2 et Z3. Il dispose d'une boîte auxiliaire pour encastré dans le site de construction. Il comprend une protection en verre trempé, qui a une résistance de 5000 kg.
- Optique:** Intégré dans les lampes, avec des angles d'ouverture de 120° pour Z1 et 48 ° ou 11 ° pour Z2 et Z3.
- Alimentation:** Tous les modèles incluent driver et des lampes.
- Lampes:** LED Osram, Duris E5 pour Z1 et Oslon SSL pour Z2 / Z3.
- Installation:** Installation au sol par boîte auxiliaire encastré, non utilisé directement sur le sol ou de l'herbe.
- Couleurs:** Acier inoxydable.

Flopro Z1 LED circular - Recessed floor / Flopro Z1 LED circulaire - Encastré de sol



Flopro Z1 LED circular / Flopro Z1 LED circulaire

Includes driver and LED Duris E5 lamp 2w
Comprend driver et LED Duris E5 lampe 2w

Ref.	Colour / Couleur	Lamp.	W	€
6100 00 02 84	Stainless steel / Acier inoxydable / 316	LED	2w	99,90

- * Standardly supplied with maximum lamp opening angle [120°]
- * En standard fourni avec angle d'ouverture maximale de la lampe [120°]
- * Standardly supplied with 4000°K lamp.
- * En standard fourni avec 4000°K lampe.

OPTIONS LED	Ref. 83	Ref. 84	Ref. 85
CRI>80 / Colour temperature / Température de couleur	3000°K	4000°K	5700°K
Lum 2w	140	150	150

Rough increase of LED / Augmenter LED

Ref.	Lamp	Colour / Couleur / LED	W	€
6100 00 02 R	LED	Red / Rouge ●	2w	8,20
6100 00 02 G	LED	Green / Vert ●	2w	8,20
6100 00 02 B	LED	Blue / Bleu ●	2w	8,20

Rough price increase accesories / Rough price increase accesories			€
Ref. CMZ1	Matt glass / Verre mat		6,90



Protection tempered glass.
Protection en verre trempé.

Flopro Z2 LED circular - Recessed floor / Flopro Z2 LED circulaire - Encastré de sol



Flopro Z2 LED adjustable circular / orientable circulaire



Includes driver and LED lamp Oslon SSL
Comprend driver et lampe LED Oslon SSL

Ref.	Colour / Couleur	Lamp.	W	€	lum.
6120 00 06 84	Stainless steel / Acier inoxydable / 316	LED	6w	305,53	650
6120 00 10 84	Stainless steel / Acier inoxydable / 316	LED	10w	321,58	1170

- * Standardly supplied with maximum lamp opening angle (48°)
- * En standard fourni avec angle d'ouverture maximale de la lampe (48°)
- * Standardly supplied with 4000°K lamp.
- * En standard fourni avec 4000°K lampe.

Rough increase of LED / Augmenter LED

Ref.	Lamp	Colour / Couleur LED.	W	€
6120 00 06 R	LED	Red / Rouge ●	6w	9,90
6120 00 06 G	LED	Green / Vert ●	6w	9,90
6120 00 06 B	LED	Blue / Bleu ●	6w	9,90
6120 00 10 R	LED	Red / Rouge ●	10w	16,80
6120 00 10 G	LED	Green / Vert ●	10w	16,80
6120 00 10 B	LED	Blue / Bleu ●	10w	16,80

OPTIONS LED	Ref. 83	Ref. 84	Ref. 85
CRI>80 / Colour temperature / Température de couleur	3000°K	4000°K	5000°K
Lum 6w	605	650	700
Lum 7w asymmetric / asymétrique	726	780	840
Lum 10w	1089	1170	1260

Incremento di prezzo per accessori / Acessórios	6w	7w	10w
Ref. 11 Opening angle 11° / Angle d'ouverture 11°	3,20	3,60	4,20

Flopro Z2 LED asymmetric adjustable cir. / asymétrique orientable cir.



Includes driver and LED lamp Oslon SSL
Comprend driver et lampe LED Oslon SSL

Ref.	Colour / Couleur	Lamp.	W	€	lum.
6110 00 07 84	Stainless steel / Acier inoxydable / 316	LED	7w	323,82	780

- * Standardly supplied with maximum lamp opening angle (48°)
- * En standard fourni avec angle d'ouverture maximale de la lampe (48°)
- * Standardly supplied with 4000°K lamp.
- * En standard fourni avec 4000°K lampe.

Rough increase of LED / Augmenter LED

Ref.	Lamp	Colour / Couleur LED.	W	€
6110 00 07 R	LED	Red / Rouge ●	7w	12,20
6110 00 07 G	LED	Green / Vert ●	7w	12,20
6110 00 07 B	LED	Blue / Bleu ●	7w	12,20

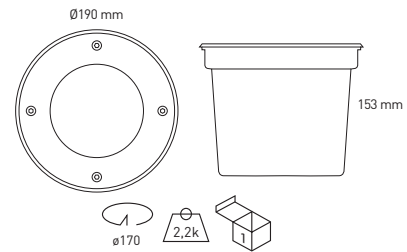

Adjustable pressing module or turning on the LED board.
Module pression orientable ou tourner sur la planche LED.

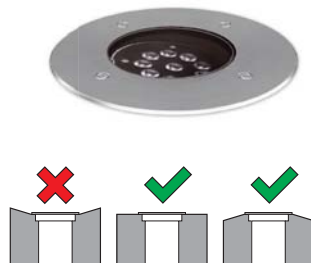

Body Corp

Flush box
Boîtier d'encastrement



Anti-condensation valve.
Valve anti-condensation.

2 connectors IP67, one input and one output.
2 connecteurs IP67, une entrée et une sortie.



Protection tempered glass.
Protection en verre trempé.



Symmetric / Symétrique



Asymmetric / Asymétrique

Flopro Z2 LED square - Recessed floor / Flopro Z2 LED carré - Encastré de sol



Flopro Z2 LED adjustable square / orientable carré

Includes driver and LED lamp Oslon SSL
Comprend driver et lampe LED Oslon SSL

Ref.	Colour / Couleur	Lamp.	W	€	lum.
6130 00 06 84	Stainless steel / Acier inoxydable / 316	LED	6w	359,15	650
6130 00 10 84	Stainless steel / Acier inoxydable / 316	LED	10w	375,48	1170

- * Standardly supplied with maximum lamp opening angle (48°)
- * En standard fourni avec angle d'ouverture maximale de la lampe (48°)
- * Standardly supplied with 4000°K lamp.
- * En standard fourni avec 4000°K lampe.

Rough increase of LED / Augmenter LED

Ref.	Lamp	Colour / Couleur LED.		W	€
6130 00 06 R	LED	Red / Rouge	●	6w	9,90
6130 00 06 G	LED	Green / Vert	●	6w	9,90
6130 00 06 B	LED	Blue / Bleu	●	6w	9,90
6130 00 10 R	LED	Red / Rouge	●	10w	16,80
6130 00 10 G	LED	Green / Vert	●	10w	16,80
6130 00 10 B	LED	Blue / Bleu	●	10w	16,80

OPTIONS LED	Ref. 83	Ref. 84	Ref. 85
CRI>80 / Colour temperature / Température de couleur	3000°K	4000°K	5000°K
Lum 6w	605	650	700
Lum 7w asymmetric / asymétrique	726	780	840
Lum 10w	1089	1170	1260

Incremento di prezzo per accessori / Acessórios	6w	7w	10w
Ref. 11 Opening angle 11° / Angle d'ouverture 11°	3,20	3,60	4,20

Flopro Z2 LED asymmetric adjustable sq. / asymétrique orientable carré

Includes driver and LED lamp Oslon SSL
Comprend driver et lampe LED Oslon SSL

Ref.	Colour / Couleur	Lamp.	W	€	lum.
6140 00 07 84	Stainless steel / Acier inoxydable / 316	LED	7w	377,78	780

- * Standardly supplied with maximum lamp opening angle (48°)
- * En standard fourni avec angle d'ouverture maximale de la lampe (48°)
- * Standardly supplied with 4000°K lamp.
- * En standard fourni avec 4000°K lampe.

Rough increase of LED / Augmenter LED

Ref.	Lamp	Colour / Couleur LED.		W	€
6140 00 07 R	LED	Red / Rouge	●	7w	12,20
6140 00 07 G	LED	Green / Vert	●	7w	12,20
6140 00 07 B	LED	Blue / Bleu	●	7w	12,20

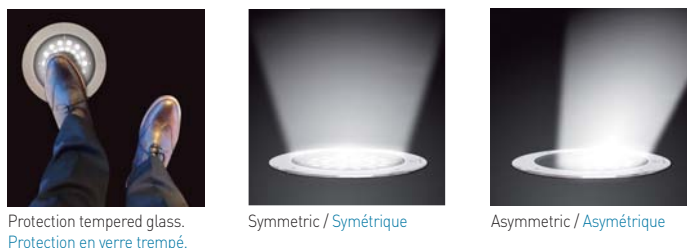
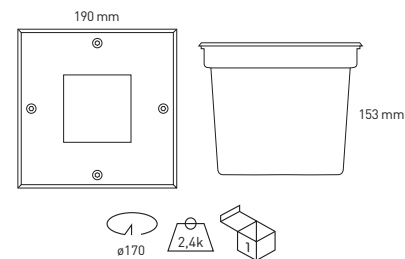

Flopro Z3 LED circular - Recessed floor / Flopro Z3 LED circulaire - Encastré de sol



Flopro Z3 LED adjustable circular / orientable circulaire

Includes driver and LED lamp Oslon SSL
Comprend driver et lampe LED Oslon SSL

Ref.	Colour / Couleur	Lamp.	W	€	lum.
6150 00 20 84	Stainless steel / Acier inoxydable / 316	LED	20w	549,82	2340
6150 00 30 84	Stainless steel / Acier inoxydable / 316	LED	28w	596,12	3315

- * Standardly supplied with maximum lamp opening angle [48°]
- * En standard fourni avec angle d'ouverture maximale de la lampe [48°]
- * Standardly supplied with 4000°K lamp.
- * En standard fourni avec 4000°K lampe.

Rough increase of LED / Augmenter LED

Ref.	Lamp	Colour / Couleur LED.	W	€
6150 00 20 R	LED	Red / Rouge ●	20w	34,90
6150 00 20 G	LED	Green / Vert ●	20w	34,90
6150 00 20 B	LED	Blu / Azul ●	20w	34,90
6150 00 30 R	LED	Red / Rouge ●	28w	69,90
6150 00 30 G	LED	Green / Vert ●	28w	69,90
6150 00 30 B	LED	Blu / Azul ●	28w	69,90

OPTIONS LED	Ref. 83	Ref. 84	Ref. 85
CRI>80 / Colour temperature / Température de couleur	3000°K	4000°K	5000°K
Lum 20w	2178	2340	2520
Lum 22w asymmetric / asymétrique	2420	2600	2800
Lum 28w	3085	3315	3570

Incremento di prezzo per accessori / Acessórios	20w	22w	28w
Ref. 11 Opening angle 11° / Angle d'ouverture 11°	8,20	8,90	16,90

Flopro Z3 LED asymmetric adjustable cir. / asymétrique orientable cir.

Includes driver and LED lamp Oslon SSL
Comprend driver et lampe LED Oslon SSL

Ref.	Colour / Couleur	Lamp.	W	€	lum.
6180 00 22 84	Stainless steel / Acier inoxydable / 316	LED	22w	598,20	2600

- * Somministrato di serie con angolo di massima apertura [48°].
- * Por defeito com ângulo de abertura máximo [48°].
- * Di serie fornito con LED 4000° K.
- * Por defeito fornecido com módulos LED 4000° K.

Rough increase of LED / Augmenter LED

Ref.	Lamp	Colour / Couleur LED.	W	€
6180 00 22 R	LED	Red / Rouge ●	22w	36,90
6180 00 22 G	LED	Green / Vert ●	22w	36,90
6180 00 22 B	LED	Blu / Azul ●	22w	36,90

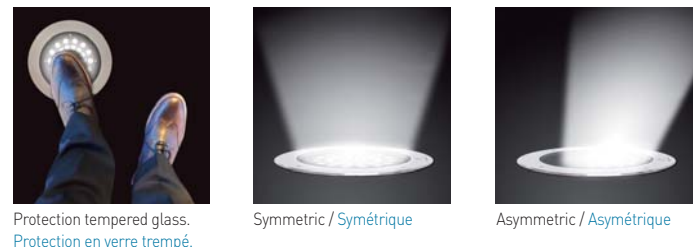
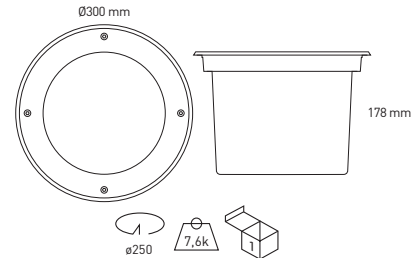

Flopro Z3 LED square - Recessed floor / Flopro Z3 LED carré - Encastré de sol



Flopro Z3 LED adjustable square / orientable carré

Includes driver and LED lamp Oslon SSL
Comprend driver et lampe LED Oslon SSL

Ref.	Colour / Couleur	Lamp.	W	€	lum.
6160 00 18 84	Stainless steel / Acier inoxydable / 316	LED	18w	582,52	2080
6160 00 30 84	Stainless steel / Acier inoxydable / 316	LED	30w	675,20	3510

- * Standardly supplied with maximum lamp opening angle (48°)
- * En standard fourni avec angle d'ouverture maximale de la lampe (48°)
- * Standardly supplied with 4000°K lamp.
- * En standard fourni avec 4000°K lampe.

Rough increase of LED / Augmenter LED

Ref.	Lamp	Colour / Couleur LED.	W	€
6160 00 18 R	LED	Red / Rouge	18w	31,42
6160 00 18 G	LED	Green / Vert	18w	31,42
6160 00 18 B	LED	Blu / Azul	18w	31,42
6160 00 30 R	LED	Red / Rouge	30w	69,90
6160 00 30 G	LED	Green / Vert	30w	69,90
6160 00 30 B	LED	Blu / Azul	30w	69,90

OPTIONS LED	Ref. 83	Ref. 84	Ref. 85
CRI>80 / Colour temperature / Température de couleur	3000°K	4000°K	5000°K
Lum 18w	1936	2080	2240
Lum 20w asymmetric / asymétrique	2178	2340	2520
Lum 30w	3267	3510	3780

Incremento di prezzo per accessori / Acessórios	18w	20w	30w
Ref. 11 Opening angle 11° / Angle d'ouverture 11°	7,90	8,90	16,90

Flopro Z3 LED asymmetric adjustable sq. / asymétrique orientable carré

Includes driver and LED lamp Oslon SSL
Comprend driver et lampe LED Oslon SSL

Ref.	Colour / Couleur	Lamp.	W	€	lum.
6170 00 20 84	Stainless steel / Acier inoxydable / 316	LED	20w	678,60	2340

- * Somministrato di serie con angolo di massima apertura (48°).
- * Por defeito com ângulo de abertura máximo (48°).
- * Di serie fornito con LED 4000° K.
- * Por defeito fornecido com módulos LED 4000° K.

Rough increase of LED / Augmenter LED

Ref.	Lamp	Colour / Couleur LED.	W	€
6170 00 20 R	LED	Red / Rouge	20w	34,90
6170 00 20 G	LED	Green / Vert	20w	34,90
6170 00 20 B	LED	Blu / Azul	20w	34,90

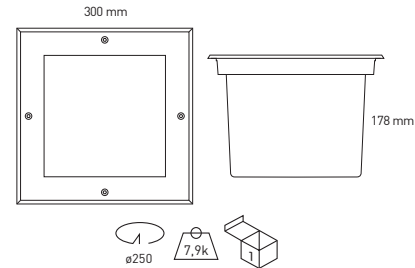

Adjustable pressing module or turning on the LED board.
Module pression orientable ou tourner sur la planche LED.

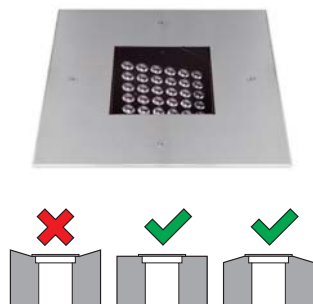

Body Corp

Flush box
Boîtier d'encastrement



Anti-condensation valve.
Valve anti-condensation.

2 connectors IP67, one input and one output.
2 connecteurs IP67, une entrée et une sortie.



Protection tempered glass.
Protection en verre trempé.



Symmetric / Symétrique



Asymmetric / Asymétrique



Ceipro C1 / C2 / C3 LED - Recessed f ceiling or wall

Protection degree IP67 / IK10

- Material:** Finished in stainless steel 316. Body of the luminaire made in injected plastic in C1, injected aluminium in C2 and C3. It includes a protection tempered glass which have 5000kg resistance.
- Óptica:** Integrated in the lamps, with opening angles of 120° for C1 and 48 ° or 11 ° for C2 and C3.
- Supply:** All models include control gear and lamps.
- Lamps:** LEDs Osram, Duris E5 for C1 and Oslon SSL for C2 / C3.
- Installation:** Circular ceiling cut. For recessed ceiling, adaptable to all kind of modular ceilings and plaster. Clamps included.
Auxiliary flush housing option for recessing in cement or concrete work.
- Colours:** Stainless steel.

Ceipro C1 / C2 / C3 LED - Encastré mur ou plafond

Degré de protection IP67 / IK10

- Matériel:** Fini en acier inoxydable 316. Corps du luminaire fabriqué en plastique injecté dans C1, aluminium injecté dans C2 et C3. Il comprend une protection en verre trempé, qui a une résistance de 5000 kg.
- Optique:** Intégré dans les lampes, avec des angles d'ouverture de 120° pour C1 et 48 ° ou 11 ° pour C2 et C3.
- Alimentation:** Tous les modèles incluent driver et des lampes.
- Lampes:** LED Osram, Duris E5 pour C1 et Oslon SSL pour C2 / C3.
- Installation:** Circulaire coupe au plafond. Pour plafond encastrable, adaptable à tous les types de plafonds modulaires et en plâtre. Pincés inclus.
- Couleurs:** Acier inoxydable.

Ceipro C1 LED circular - Recessed ceiling or wall / Ceipro C1 LED circulaire - Encastré mu ou plafond



Ceipro C1 LED circular / Ceipro C1 LED circulaire

Includes driver and LED Duris E5 lamp 2w
Comprend driver et LED Duris E5 lampe 2w

Ref.	Colour / Couleur	Lamp.	W	€
5100 00 02 84	Stainless steel / Acier inoxydable / 316	LED	2w	98,68

- * Standardly supplied with maximum lamp opening angle [120°]
- * En standard fourni avec angle d'ouverture maximale de la lampe [120°]
- * Standardly supplied with 4000°K lamp.
- * En standard fourni avec 4000°K lampe.

OPTIONS LED	Ref. 83	Ref. 84	Ref. 85
CRI>80 / Colour temperature / Température de couleur	3000°K	4000°K	5700°K
Lum 2w	140	150	150

Rough increase of LED / Augmenter LED

Ref.	Lamp	Colour / Couleur / LED	W	€
5100 00 02 R	LED	Red / Rouge ●	2w	8,20
5100 00 02 G	LED	Green / Vert ●	2w	8,20
5100 00 02 B	LED	Blue / Bleu ●	2w	8,20

Incremento di prezzo per accessori / Acessórios	€
Ref. CMZ1 Matt glass / Verre mat	6,90
Ref. 51C1 Caja empotrable en obra / Boîte encastré sur place	5,52

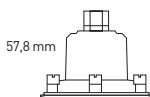

1 connector IP67.
1 connecteur IP67.



Clamps.
Pincés.



Ref. 51C1
Recessed auxiliary box on site.
Boîte auxiliaire encastré sur place



Ceipro C2 LED circular - Recessed ceiling or wall / Ceipro C2 LED circulaire - Encastré mu ou plafond



Ceipro C2 LED adjustable circular / orientable circulaire



Includes driver and LED lamp Oslon SSL
Comprend driver et lampe LED Oslon SSL

Ref.	Colour / Couleur	Lamp.	W	€	lum.
5120 00 06 84	Stainless steel / Acier inoxydable / 316	LED	6w	298,70	650
5120 00 10 84	Stainless steel / Acier inoxydable / 316	LED	10w	312,90	1170

- * Standardly supplied with maximum lamp opening angle (48°)
- * En standard fourni avec angle d'ouverture maximale de la lampe (48°)
- * Standardly supplied with 4000°K lamp.
- * En standard fourni avec 4000°K lampe.

Rough increase of LED / Augmenter LED

Ref.	Lamp	Colour / Couleur LED.	W	€
5120 00 06 R	LED	Red / Rouge ●	6w	9,90
5120 00 06 G	LED	Green / Vert ●	6w	9,90
5120 00 06 B	LED	Blue / Bleu ●	6w	9,90
5120 00 10 R	LED	Red / Rouge ●	10w	16,80
5120 00 10 G	LED	Green / Vert ●	10w	16,80
5120 00 10 B	LED	Blue / Bleu ●	10w	16,80

OPTIONS LED	Ref. 83	Ref. 84	Ref. 85
CRI>80 / Colour temperature / Température de couleur	3000°K	4000°K	5000°K
Lum 6w	605	650	700
Lum 7w asymmetric / asymétrique	726	780	840
Lum 10w	1089	1170	1260

Incremento di prezzo per accessori / Acessórios	6w	7w	10w
Ref. 11 Opening angle 11° / Angle d'ouverture 11°	3,20	3,60	4,20

Incremento di prezzo per accessori / Acessórios	€
Ref. 51C2 Caja empotrable en obra / Boîte encastré sur place	6,94

Ceipro C2 LED asymmetric adjustable cir. / asymétrique orientable cir.



Includes driver and LED lamp Oslon SSL
Comprend driver et lampe LED Oslon SSL

Ref.	Colour / Couleur	Lamp.	W	€	lum.
5110 00 07 84	Stainless steel / Acier inoxydable / 316	LED	7w	317,60	780

- * Standardly supplied with maximum lamp opening angle (48°)
- * En standard fourni avec angle d'ouverture maximale de la lampe (48°)
- * Standardly supplied with 4000°K lamp.
- * En standard fourni avec 4000°K lampe.

Rough increase of LED / Augmenter LED

Ref.	Lamp	Colour / Couleur LED.	W	€
5110 00 07 R	LED	Red / Rouge ●	7w	12,20
5110 00 07 G	LED	Green / Vert ●	7w	12,20
5110 00 07 B	LED	Blue / Bleu ●	7w	12,20

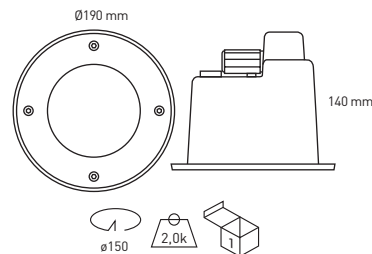

Adjustable pressing module or turning on the LED board.
Module pression orientable ou tourner sur la planche LED.



Ref. 51C2
Recessed auxiliary box on site.
Boîte auxiliaire encastré sur place.



Symmetric / Symétrique



Asymmetric / Asymétrique

Ceipro C2 LED square - Recessed ceiling or wall / Ceipro C2 LED carré - Encastré mu ou plafond



Ceipro C2 LED adjustable square / orientable carré



Includes driver and LED lamp Oslon SSL
Comprend driver et lampe LED Oslon SSL

Ref.	Colour / Couleur	Lamp.	W	€	lum.
5130 00 06 84	Stainless steel / Acier inoxydable / 316	LED	6w	349,90	650
5130 00 10 84	Stainless steel / Acier inoxydable / 316	LED	10w	367,90	1170

- * Standardly supplied with maximum lamp opening angle (48°)
- * En standard fourni avec angle d'ouverture maximale de la lampe (48°)
- * Standardly supplied with 4000°K lamp.
- * En standard fourni avec 4000°K lampe.

Rough increase of LED / Augmenter LED

Ref.	Lamp	Colour / Couleur LED.		W	€
5130 00 06 R	LED	Red / Rouge	●	6w	9,90
5130 00 06 G	LED	Green / Vert	●	6w	9,90
5130 00 06 B	LED	Blue / Bleu	●	6w	9,90
5130 00 10 R	LED	Red / Rouge	●	10w	16,80
5130 00 10 G	LED	Green / Vert	●	10w	16,80
5130 00 10 B	LED	Blue / Bleu	●	10w	16,80

OPTIONS LED	Ref. 83	Ref. 84	Ref. 85
CRI>80 / Colour temperature / Température de couleur	3000°K	4000°K	5000°K
Lum 6w	605	650	700
Lum 7w asymmetric / asymétrique	726	780	840
Lum 10w	1089	1170	1260

Incremento di prezzo per accessori / Acessórios	6w	7w	10w
Ref. 11 Opening angle 11° / Angle d'ouverture 11°	3,20	3,60	4,20

Incremento di prezzo per accessori / Acessórios	€
Ref. 51C2 Caja empotrable en obra / Boîte encastré sur place	6,94

Adjustable pressing module or turning on the LED board.
Module pression orientable ou tourner sur la planche LED.



Ref. 51C2
Recessed auxiliary box on site.
Boîte auxiliaire encastré sur place.

Ceipro C2 LED asymmetric adjustable sq. / asymétrique orientable carré



Includes driver and LED lamp Oslon SSL
Comprend driver et lampe LED Oslon SSL

Ref.	Colour / Couleur	Lamp.	W	€	lum.
5140 00 07 84	Stainless steel / Acier inoxydable / 316	LED	7w	370,20	780

- * Standardly supplied with maximum lamp opening angle (48°)
- * En standard fourni avec angle d'ouverture maximale de la lampe (48°)
- * Standardly supplied with 4000°K lamp.
- * En standard fourni avec 4000°K lampe.

Rough increase of LED / Augmenter LED

Ref.	Lamp	Colour / Couleur LED.		W	€
5140 00 07 R	LED	Red / Rouge	●	7w	12,20
5140 00 07 G	LED	Green / Vert	●	7w	12,20
5140 00 07 B	LED	Blue / Bleu	●	7w	12,20

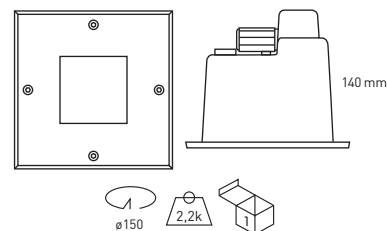

Body Corp
2 connectors IP67, one input and one output.
2 connecteurs IP67, une entrée et une sortie.

Clamps.
Pincés.

Anti-condensation valve.
Valve anti-condensation.



Symmetric / Symétrique



Asymmetric / Asymétrique

Ceipro C3 LED circular - Recessed ceiling or wall / Ceipro C3 LED circulaire - Encastré mu ou plafond



Ceipro C3 LED adjustable circular / orientable circulaire

Includes driver and LED lamp Oslon SSL
Comprend driver et lampe LED Oslon SSL

Ref.	Colour / Couleur	Lamp.	W	€	lum.
5150 00 20 84	Stainless steel / Acier inoxydable / 316	LED	20w	547,32	2340
5150 00 30 84	Stainless steel / Acier inoxydable / 316	LED	28w	589,90	3315

- * Standardly supplied with maximun lamp opening angle [48°]
- * En standard fourni avec angle d'ouverture maximale de la lampe [48°]
- * Standardly supplied with 4000°K lamp.
- * En standard fourni avec 4000°K lampe.

Rough increase of LED / Augmenter LED

Ref.	Lamp	Colour / Couleur LED.		W	€
5150 00 20 R	LED	Red / Rouge ●		20w	34,90
5150 00 20 G	LED	Green / Vert ●		20w	34,90
5150 00 20 B	LED	Blu / Azul ●		20w	34,90
5150 00 30 R	LED	Red / Rouge ●		28w	69,90
5150 00 30 G	LED	Green / Vert ●		28w	69,90
5150 00 30 B	LED	Blu / Azul ●		28w	69,90

OPTIONS LED	Ref. 83	Ref. 84	Ref. 85
CRI>80 / Colour temperature / Température de couleur	3000°K	4000°K	5000°K
Lum 20w	2178	2340	2520
Lum 22w asymmetric / asymétrique	2420	2600	2800
Lum 28w	3085	3315	3570

Incremento di prezzo per accessori / Acessórios	20w	22w	28w
Ref. 11 Opening angle 11° / Angle d'ouverture 11°	8,20	8,90	16,90

Incremento di prezzo per accessori / Acessórios	€
Ref. 51C3 Caja empotrable en obra / Boîte encastré sur place	12,90

Adjustable pressing module or turning on the LED board.
Module pression orientable ou tourner sur la planche LED.



Ref. 51C3 Recessed auxiliary box on site.
Boîte auxiliaire encastré sur place.



CEIPRO C3 LED asymmetric adjustable cir. / asymétrique orientable cir.

Includes driver and LED lamp Oslon SSL
Comprend driver et lampe LED Oslon SSL

Ref.	Colour / Couleur	Lamp.	W	€	lum.
5180 00 22 84	Stainless steel / Acier inoxydable / 316	LED	22w	599,90	2600

- * Somministrato di serie con angolo di massima apertura [48°].
- * Por defeito com ângulo de abertura máximo [48°].
- * Di serie fornito con LED 4000° K.
- * Por defeito fornecido com módulos LED 4000° K.

Rough increase of LED / Augmenter LED

Ref.	Lamp	Colour / Couleur LED.		W	€
5180 00 22 R	LED	Red / Rouge ●		22w	36,90
5180 00 22 G	LED	Green / Vert ●		22w	36,90
5180 00 22 B	LED	Blu / Azul ●		22w	36,90

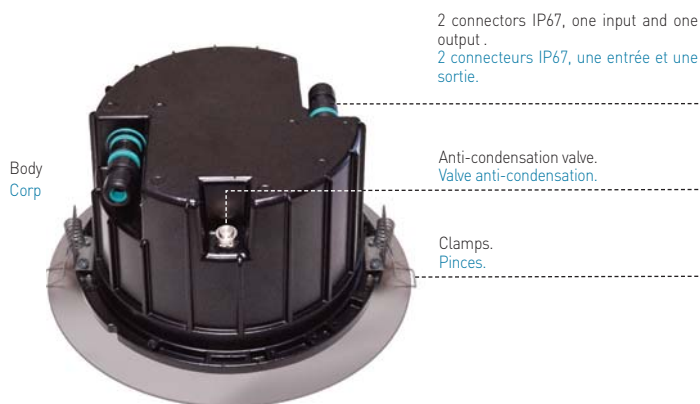
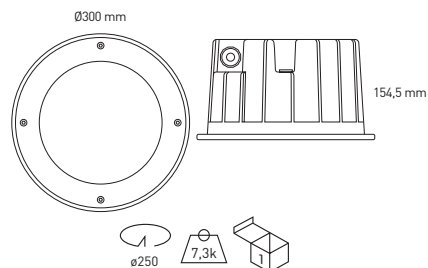

2 connectors IP67, one input and one output.
2 connecteurs IP67, une entrée et une sortie.

Anti-condensation valve.
Valve anti-condensation.

Clamps.
Pincés.



Symmetric / Symétrique



Asymmetric / Asymétrique

Ceipro C3 LED square - Recessed ceiling or wall / Ceipro C3 LED carré - Encastré mu ou plafond



Ceipro C3 LED adjustable square / orientable carré

Includes driver and LED lamp Oslon SSL
Comprend driver et lampe LED Oslon SSL

Ref.	Colour / Couleur	Lamp.	W	€	lum.
5160 00 18 84	Stainless steel / Acier inoxydable / 316	LED	18w	578,10	2080
5160 00 30 84	Stainless steel / Acier inoxydable / 316	LED	30w	630,20	3510

- * Standardly supplied with maximum lamp opening angle (48°)
- * En standard fourni avec angle d'ouverture maximale de la lampe (48°)
- * Standardly supplied with 4000°K lamp.
- * En standard fourni avec 4000°K lampe.

Rough increase of LED / Augmenter LED

Ref.	Lamp	Colour / Couleur LED.		W	€
5160 00 18 R	LED	Red / Rouge	●	18w	31,42
5160 00 18 G	LED	Green / Vert	●	18w	31,42
5160 00 18 B	LED	Blu / Azul	●	18w	31,42
5160 00 30 R	LED	Red / Rouge	●	30w	69,90
5160 00 30 G	LED	Green / Vert	●	30w	69,90
5160 00 30 B	LED	Blu / Azul	●	30w	69,90

OPTIONS LED	Ref. 83	Ref. 84	Ref. 85
CRI>80 / Colour temperature / Température de couleur	3000°K	4000°K	5000°K
Lum 18w	1936	2080	2240
Lum 20w asymmetric / asymétrique	2178	2340	2520
Lum 30w	3267	3510	3780

Incremento di prezzo per accessori / Acessórios	18w	20w	30w
Ref. 11 Opening angle 11° / Angle d'ouverture 11°	7,90	8,90	16,90

Incremento di prezzo per accessori / Acessórios	€
Ref. 51C3 Caja empotrable en obra / Boîte encastré sur place	12,90

Adjustable pressing module or turning on the LED board.
Module pression orientable ou tourner sur la planche LED.



Ref. 51C3 Recessed auxiliary box on site.
Boîte auxiliaire encastré sur place.



Ceipro C3 LED asymmetric adjustable sq. / asymétrique orientable carré

Includes driver and LED lamp Oslon SSL
Comprend driver et lampe LED Oslon SSL

Ref.	Colour / Couleur	Lamp.	W	€	lum.
5170 00 20 84	Stainless steel / Acier inoxydable / 316	LED	20w	653,50	2340

- * Somministrato di serie con angolo di massima apertura (48°).
- * Por defeito com ângulo de abertura máximo (48°).
- * Di serie fornito con LED 4000° K.
- * Por defeito fornecido com módulos LED 4000° K.

Rough increase of LED / Augmenter LED

Ref.	Lamp	Colour / Couleur LED.		W	€
5170 00 20 R	LED	Red / Rouge	●	20w	34,90
5170 00 20 G	LED	Green / Vert	●	20w	34,90
5170 00 20 B	LED	Blu / Azul	●	20w	34,90

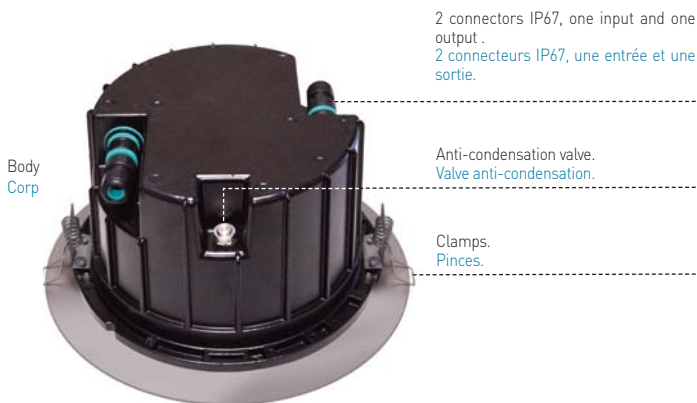
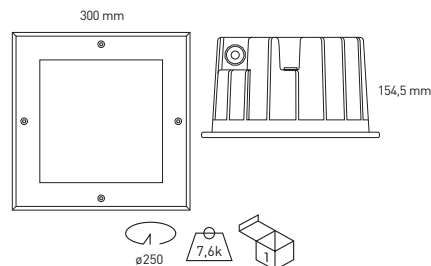

2 connectors IP67, one input and one output.
2 connecteurs IP67, une entrée et une sortie.

Anti-condensation valve.
Valve anti-condensation.

Clamps.
Pincés.



Symmetric / Symétrique



Asymmetric / Asymétrique

Protek City LED

Protection degree **IP65** / Impact protection index **IK08**

- Material:** Body made of injected aluminum, thermo painted.
- Optics:** Optic included in the LED lamps. Includes waterproof polycarbonate protection with UV protection.
- Supply:** Driver included for all models. Can be supplied with dimmable driver 1-10V (DR) and double level dimmable (DN).
- Lamps:** Osram Leds Module composed Duris E5 with 16/25/50W power. CRI > 80 and available 3000K, 4000K and 5700K.
- Life span:** Estimated Average Life span 50.000 hours.
- Installation:** Column or crossier of $\varnothing 60$ mm. It can be supplied in other dimension by request. One quick connector of 3 or 5 poles allows the installation without opening the luminaire.
- Colours:** White, black and grey. It can be supplied in other RAL colours by request.

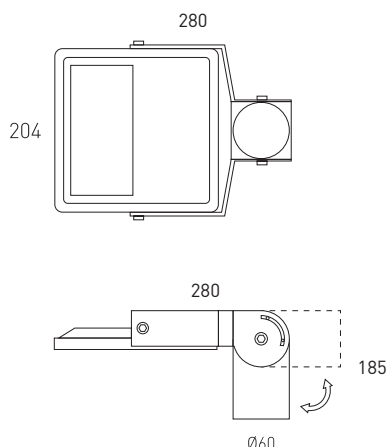

Protek City LED

Degré de protection **IP65**/ Indice de protection anti-vandalisme **IK08**

- Matériel:** Corps fabriqué en aluminium injecté avec un recouvrement en époxy polycarbonate cuit au four.
- Optique:** Optique avec lampes incluses. Incluant un diffuseur protecteur polycarbonate, étanche, traité avec une protection contre les UV.
- Alimentation:** Tous les modèles sont équipés de leur appareillage. En option, il peut être fournie avec un DRIVER 1-10V, DRIVER DALI, régulation double niveau.
- Lampes:** Modèle équipé de LED OSRAM DURIS E5 avec une puissance total de 16/25/50w. CRI 80. Disponible en 3000K, 4000K, 5700K.
- Durée de vie estimée:** Longévité moyenne estimée à 50 000 heures.
- Installation:** Installation sur colonne ou mat de 60mm de diamètre. Autres dimensions sur demande. Un connecteur rapide de 3 ou 5 pôles permet d'installer le luminaire sans avoir besoin de l'ouvrir. IP65
- Couleurs:** Blanc, noir ou gris. Disponible dans d'autres couleurs sur demande.



Protek City LED Protek City LED



Includes driver and LED lamp
Comprend lampe LED et drive

Ref.	Colour / Couleur	Lamp.	Lumens	W	€
4179 58 16 85	Gray / Gris	LED	2110	16w	216,50
4179 58 25 85	Gray / Gris	LED	3162	25w	221,00
4179 58 50 85	Gray / Gris	LED	6332	50w	259,20

* Standardly supplied with 5700°K LED lamp.
* En standard fourni avec lampe 5700° K LED.

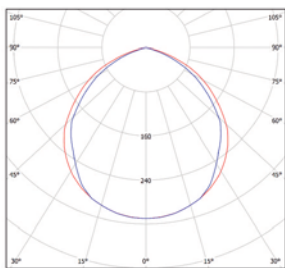

Transparent diffuser
Diffuseur transparent

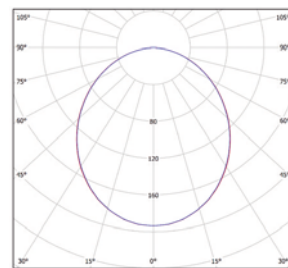

Ref. 4131 Opal diffuser
Diffuseur Opal

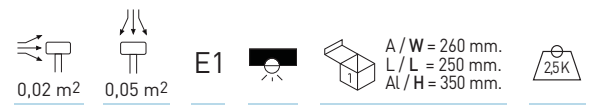

OPTIONS LED		Ref. 83	Ref. 84	Ref. 85
CRI>80 / Colour temp. / Température de couleur	W	3000°K	4000°K	5700°K
Lumens Osram Duris E5	16w	1939	2110	2110
	25w	2909	3162	3162
	50w	5818	6332	6332

OPTIONS

Rough price increase of drivers / Accessoires		16w	25w	50w
Ref. DR	Dimmable driver 1 - 10v / Driver dimmable 1-10V	31,20	31,20	80,00
Ref. DN	Double level dimmable / Double dimmable de niveau	40,00	40,00	42,00
Ref. DRP	Programmable driver / Driver programmable	71,30	71,30	-
Ref. DRPNTC	Prog. driver & NTC control / Driver prom. et sonde NTC	110,60	110,60	-
Ref. 4160	Driver 12V lighting / Driver 12V éclairage	15,00	15,00	-

Rough price increase of accessories / Accessoires		€
Ref. 4131	Opal diffuser / Diffuseur opale	9,90
Ref. AM	Special paint marine environment / Peinture spéciale environnement marin	60,00
Ref. IK10	Impact protection index / Indice de protection anti-vandalismo	12,50

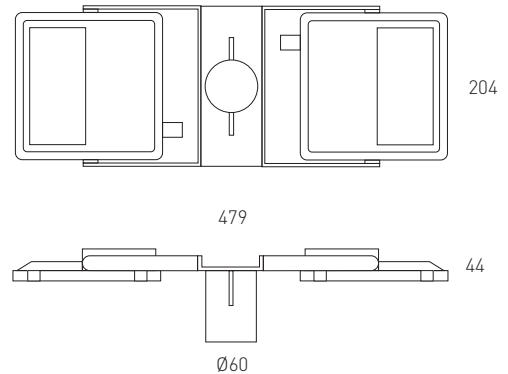

Protek City LED Duo

Includes two Protek City LED and Duo support.
 Protek City LED comprend deux unités et support Duo.

Ref.	Colour / Couleur	Lamp.	Lumens	W	€
4177 58 16 85	Gray / Gris	LED	4220	2x16w	388,90
4177 58 25 85	Gray / Gris	LED	6324	2x25w	399,80
4177 58 50 85	Gray / Gris	LED	12664	2x50w	483,60

* Standardly supplied with 5700°K LED lamp.
 * En standard fourni avec lampe 5700° K LED.

OPTIONS LED		Ref. 83	Ref. 84	Ref. 85
CRI>80 / Colour temp. / Température de couleur	W	3000°K	4000°K	5700°K
Lumens Osram Duris E5	16w	1939	2110	2110
	25w	2909	3162	3162
	50w	5818	6332	6332

OPCIONES / OPTIONS

Rough price increase of drivers / Accesories		16w	25w	50w
Ref. DR	Dimmable driver 1 - 10v / Driver dimmable 1-10V	31,20	31,20	80,00
Ref. DN	Double level dimmable / Double dimmable de niveau	40,00	40,00	42,00
Ref. DRP	Programmable driver / Driver programmable	105,00	105,00	-
Ref. DRPNTC	Prog. driver & NTC control / Driver prom. et sonde NTC	110,60	110,60	-
Ref. 4160	Driver 12V lighting / Driver 12V éclairage	15,00	15,00	-

Rough price increase of accessories / Accessoires		€
Ref. 4131	Opal diffuser / Diffuseur opale	9,90
Ref. AM	Special paint marine environment / Peinture spéciale environnement marin	90,00
Ref. IK10	Impact protection index / Indice de protection anti-vandalismo	25,00

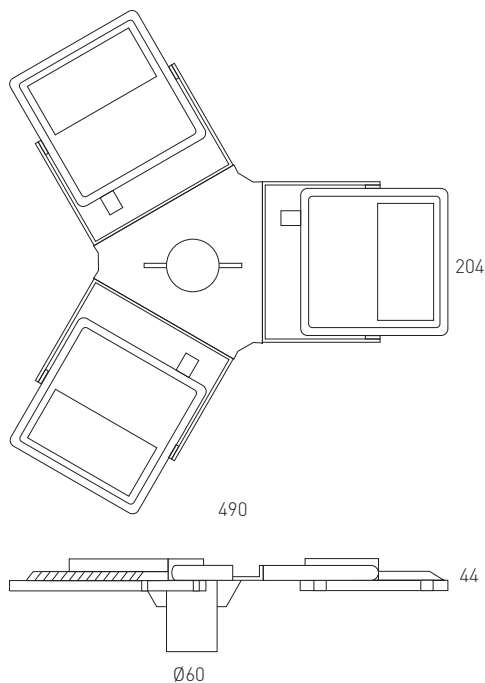

Protek City LED Trio

Includes three Protek City LED and trio support.
Protek City LED comprend trois unités et support trio.

Ref.	Colour / Couleur	Lamp.	Lumens	W	€
4178 58 16 85	Gray / Gris	LED	6330	3x16w	530,80
4178 58 25 85	Gray / Gris	LED	9486	3x25w	545,60
4178 58 50 85	Gray / Gris	LED	19000	3x50w	665,80

* Standardly supplied with 5700°K LED lamp.
* En standard fourni avec lampe 5700° K LED.

Rough price increase of accessories / Accessoires					€
Ref. AM	Special paint marine environment / Peinture spéciale environnement marin				110,00
Ref. IK10	Impact protection index / Indice de protection anti-vandalismo				37,50

Protek Q2 City LED

Protection degree **IP65** / Impact protection index **IK08**

Material:	Body made of injected aluminum, thermo painted
Optics:	Optic included in the LED lamps. Includes waterproof polycarbonate protection with UV protection.
Supply:	Driver included for all models. Can be supplied with dimmable driver 1-10V (DR) and double level dimmable (DN).
Lamps:	Module composed by Osram SLL Osram LED with a total power of 100w, 150w and 200w. Standardly supplied with a temperature of 5700°k. It can be optionally supplied with temperatures of 3000°K and 4000°k. Colour rendering index superior than 80 (CRI> 80).
Life span:	Estimated Average Life span 50.000 hours.
Installation:	Column or crossbar of ø60mm. It can be supplied in other dimension by request. One quick connector of 3 or 5 poles allows the installation without opening the luminaire.
Colours:	White, black and grey. It can be supplied in other RAL colours by request.

Protek Q2 City LED

Degré de protection **IP65**/ Indice de protection anti-vandalisme **IK08**

Matériel:	Corps fabriqué en aluminium injecté avec une couverture de peinture au four.
Optique:	Optique incluse dans des lampes LED. Inclue polycarbonate protecteur étanché avec protection UV.
Alimentation:	Driver inclus dans tous les modèles. Peut être fourni optionnellement avec driver réglable 1-10V (DR), réglage double niveau (DN).
Lampes:	Module composé par LEDs Osram Osram SLL de avec une puissance totale de 100w, 150w et 200w. Il est fourni de manière standard avec une température de 5700°K. Il peut être fourni optionnellement avec températures de 3000°K et 4000°K. Indice de reproduction chromatique supérieure à 80 (CRI>80).
Durée de vie estimée:	Longévité moyenne estimée à 50 000 heures.
Installation:	Sur colonne ou crosse de 60mm de diamètre. Autres dimensions à basse demande. Un connecteur rapide de 3 à 5 pôles permet d'installer l'éclairage sans nécessité de l'ouvrir. IP65.
Couleurs:	Blanc, noir et gris. Disponible en autres couleurs RAL à basse demande.

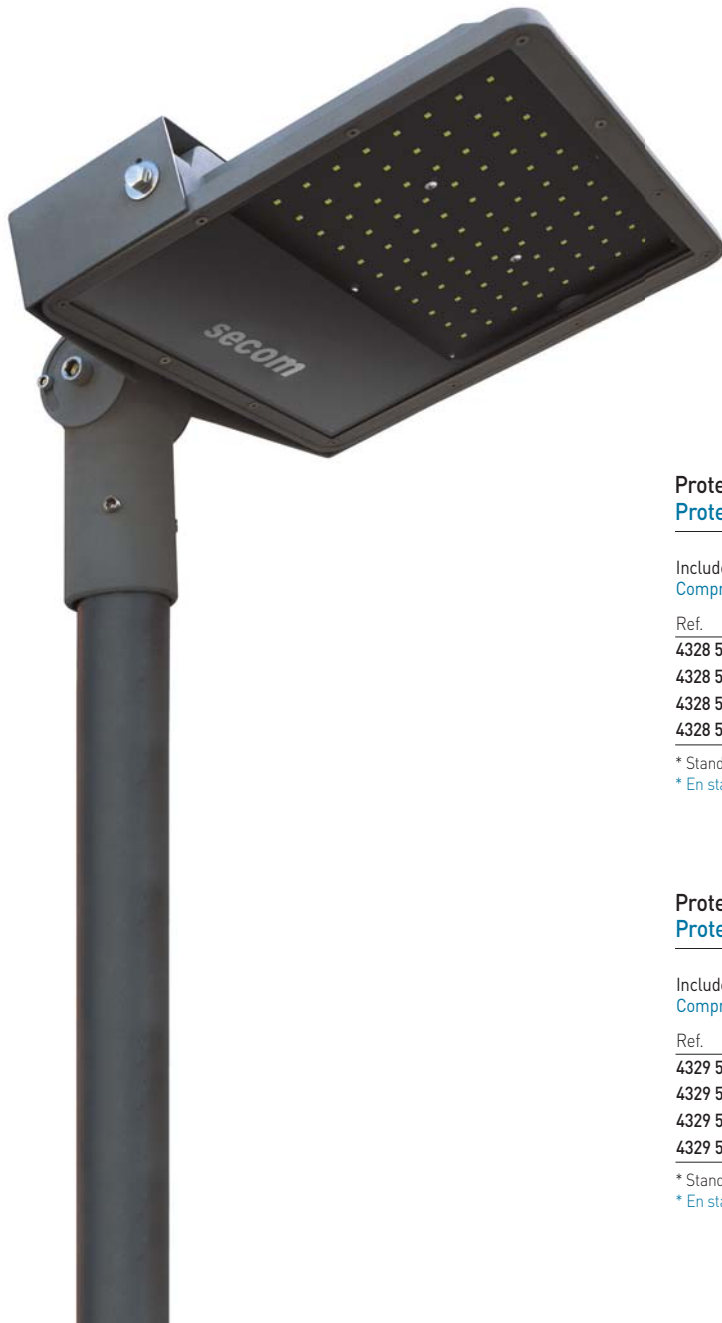

Protek Q2 City LED - Symmetric optical 150° Protek Q2 City LED - Symétrique optical 150°



Includes driver and LED lamp
Comprend lampe LED et drive

Ref.	Colour / Couleur	Lamp.	Lumens	W	€
4328 58 60 85	Gray / Gris	LED	8820	60w	524,10
4328 58 10 85	Gray / Gris	LED	13545	100w	554,20
4328 58 15 85	Gray / Gris	LED	20160	150w	672,40
4328 58 20 85	Gray / Gris	LED	27090	200w	820,40

* Standardly supplied with 5700°K LED lamp.
* En standard fourni avec lampe 5700° K LED.

Protek Q2 City LED - Symmetric optical 80° Protek Q2 City LED - Symétrique optical 80°



Includes driver and LED lamp
Comprend lampe LED et drive

Ref.	Colour / Couleur	Lamp.	Lumens	W	€
4329 58 60 85	Gray / Gris	LED	7350	60w	526,20
4329 58 10 85	Gray / Gris	LED	11287	100w	562,80
4329 58 15 85	Gray / Gris	LED	16800	150w	674,20
4329 58 20 85	Gray / Gris	LED	22575	200w	822,50

* Standardly supplied with 5700°K LED lamp.
* En standard fourni avec lampe 5700° K LED.

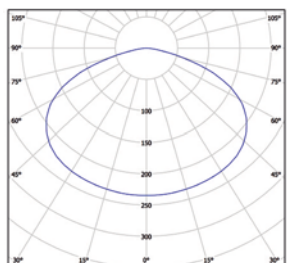
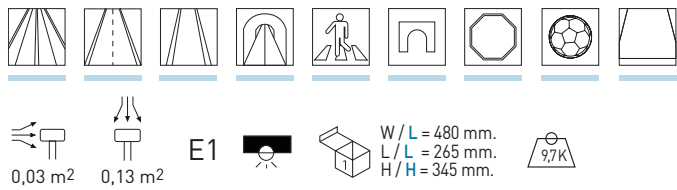
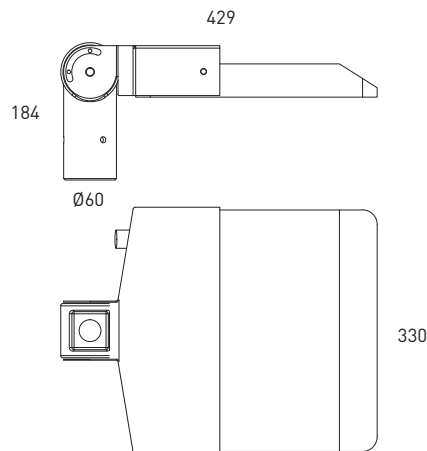

Symmetric optical 150°
Optique symmetric 150°

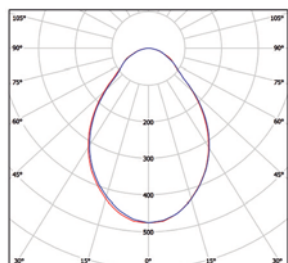

Symmetric optical 80°
Optique symmetric 80°

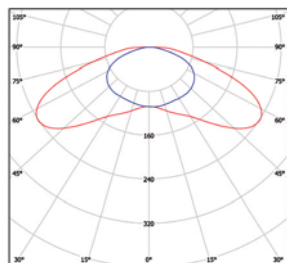

Ref. 3407 Asymmetric optical 150°
Optique Asymmetric 150°

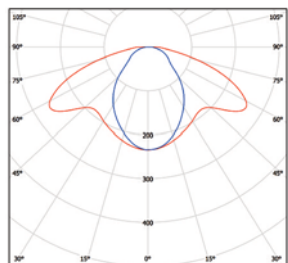

Ref. 3407 Asymmetric optical 80°
Optique asymmetric 80°

OPTIONS LED		Ref. 83	Ref. 84	Ref. 85
CRI>80 / Colour temp. / Temp. de couleur	Amber/Ambre	3000°K	4000°K	5000°K
Lum 60w	5488	6860	7105	7350
Lum 100w	8232	10535	10911	11287
Lum 150w	12544	15680	16240	16800
Lum 200w	17248	21070	21822	22575

Rough price increase of driver / Accessoires	60w	100w	150w	200w
Ref. DR Dimmable driver 1 - 10v / Driver dimmable 1-10V	90,00	90,00	95,00	50,00
Ref. DRD Driver dimmable Dali / Dimmable driver Dali	90,00	90,00	95,00	90,00
Ref. DRP Programmable driver / Programmable driver	90,00	90,00	95,00	-
Ref. DRPNTC Prog. driver & NTC control / Driver prom. et sonde NTC	110,60	110,60	110,60	-
Ref. DRM8 Motion detector / Détecteur de mouvement	137,00	137,00	152,00	-
Ref. DRC Regulación en the head / Règlement tête	90,00	90,00	95,00	-

Rough price increase of accessories / Accesories	60w	100w	150w	200w
Ref. 3407 LEDs with asym. optics / LED avec optique asymétrique	39,90	55,60	93,50	117,30
Ref. 3409 LEDs with sym. optics 48° / LED avec optique symétrique 48°	72,24	72,24	112,60	140,00
Ref. 3390 Surge protector / Protection contre les surtensions	19,00	19,00	19,00	-
Ref. AMB Amber LED / Ambre LED	39,80	76,60	119,40	159,20

Rough price increase of accessories / Accessoires	€
Ref. AM Special paint marine environment / Peinture spéciale environnement marin	90,00
Ref. IK10 Impact protection index / Indice de protection anti-vandalismo	12,50

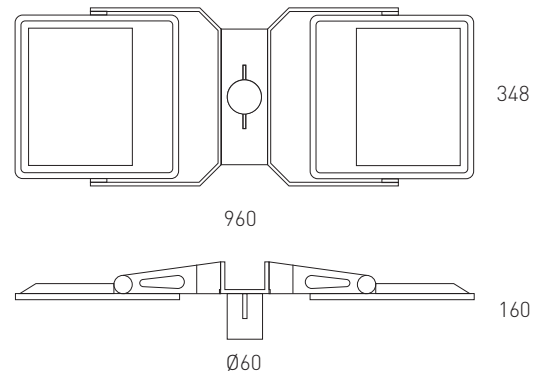
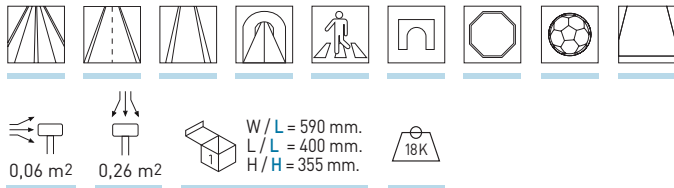

Protek Q2 City LED Duo - Symmetric optical 150° Protek Q2 City LED Duo - Symétrique optical 150°



Includes driver and LED lamp
Comprend lampe LED et drive

Ref.	Colour / Couleur	Lamp.	Lumens	W	€
4324 58 10 85	Gray / Gris	LED	17640	2x60w	1027,80
4324 58 10 85	Gray / Gris	LED	27090	2x100w	1114,40
4324 58 15 85	Gray / Gris	LED	40320	2x150w	1484,20
4324 58 20 85	Gray / Gris	LED	54180	2x200w	1779,60

* Standardly supplied with 5700°K LED lamp.
* En standard fourni avec lampe 5700° K LED.

Protek Q2 City LED Duo - Symmetric optical 80° Protek Q2 City LED Duo - Symétrique optical 80°



Includes driver and LED lamp
Comprend lampe LED et drive

Ref.	Colour / Couleur	Lamp.	Lumens	W	€
4325 58 10 85	Gray / Gris	LED	14700	2x60w	1033,20
4325 58 10 85	Gray / Gris	LED	22574	2x100w	1118,30
4325 58 15 85	Gray / Gris	LED	33600	2x150w	1488,80
4325 58 20 85	Gray / Gris	LED	45150	2x200w	1783,80

* Standardly supplied with 5700°K LED lamp.
* En standard fourni avec lampe 5700° K LED.

Rough price increase of accessories / Accessoires		€
Ref. AM	Special paint marine environment / Peinture spéciale environnement marin	120,00
Ref. IK10	Impact protection index / Indice de protection anti-vandalismo	25,00

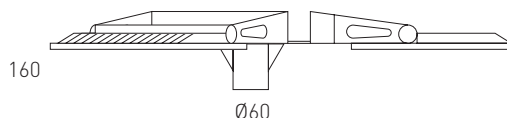
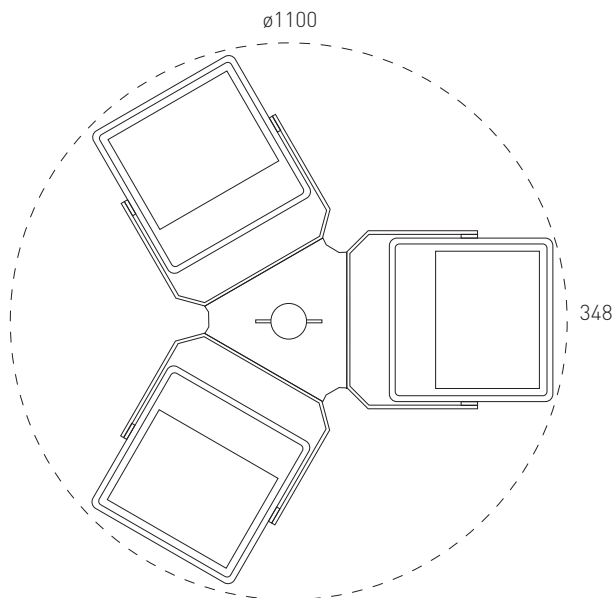

Protek Q2 City LED Trio - Symmetric optical 150°
Protek Q2 City LED Trio - Symétrique optical 150°



Includes driver and LED lamp
 Comprend lampe LED et drive

Ref.	Colour / Couleur	Lamp.	Lumens	W	€
4326 58 60 85	Gray / Gris	LED	26460	3x60w	1526,10
4326 58 10 85	Gray / Gris	LED	40635	3x100w	1656,10
4326 58 15 85	Gray / Gris	LED	60480	3x150w	2209,60
4326 58 20 85	Gray / Gris	LED	81270	3x200w	2658,10

* Standardly supplied with 5700°K LED lamp.
 * En standard fourni avec lampe 5700° K LED.

Protek Q2 City LED Trio - Symmetric optical 80°
Protek Q2 City LED Trio - Symétrique optical 80°



Includes driver and LED lamp
 Comprend lampe LED et drive

Ref.	Colour / Couleur	Lamp.	Lumens	W	€
4327 58 60 85	Gray / Gris	LED	22050	3x60w	1534,10
4327 58 10 85	Gray / Gris	LED	33861	3x100w	1663,00
4327 58 15 85	Gray / Gris	LED	50400	3x150w	2216,50
4327 58 20 85	Gray / Gris	LED	67725	3x200w	2664,40

* Standardly supplied with 5700°K LED lamp.
 * En standard fourni avec lampe 5700° K LED.

Rough price increase of accessories / Accessoires €

Ref. AM Special paint marine environment / Peinture spéciale environnement marin 150,00

Ref. IK10 Impact protection index / Indice de protection anti-vandalismo 37,50

Ecodut K1 LED

Protection degree **IP66** / Impact protection index **IK08**

- Material:** Body made of injected aluminum, blasting and polyester thermo painted without TGIC. Outdoor resistance. Optionally it can be supplied with special paint resistant to marine environment.
- Optics:** 80° / 150° optics included in LED lamps. Available several asymmetric optics LEDIL brand (Finland). Closure in methacrylate (PMMA) for good light path LEDs and UV resistance.
- Supply:** Driver included for all models, power factor > 0.95. It can be provided optionally with 1-10V dimmable driver, Dali dimmable driver, programmable dimmable driver with 5 levels without control line, double power level with no line of command, header regulation, regulation with motion sensor and driver to work with 12Vdc.
- Lamps:** Osram LEDs module composed by Oslon SSL with a total power of 25w, 50w or 75w. Available in 3000°K, 4000°K or 5700°K. High purity aluminium PCB from 1,6 mm. lacquered in white colour with quick connectors.
- Protections:** Internal protection with individual diode for each LED. Standard Surge protector of 4KV driver. Available 10KV surge on request.
- Lifespan:** L70B50 60.000 hours.
- Installation:** To mount on column or crosier. Luminaire adjustable in several orientation degrees. Ø 60mm. [Other dimensions on request]. A quick connector of 3 or 5 poles, IP66, it allows the installation without opening the luminaire.
- Ambient temp.:** -20° C to 40° C. Optionally supplied with NTC temperature probe.
- Colours:** Gray colour similar to RAL 7012. Available in other RAL colours on request.

Ecodut K1 LED

Degré de protection **IP66** / Indice de protection anti-vandalisme **IK08**

- Matériel:** Corps fabriqué en aluminium injecté, grenailé et revêtement de peinture polyester cuite au four (sans TGIC), avec une résistance élevée à l'extérieur. En option, il peut être fourni avec peinture spéciale résistant à l'environnement marin.
- Optique:** Optiques 80 °/150 ° inclus dans les lampes LED. Plusieurs optiques asymétriques disponibles – Ledil (Finlande). Fermeture en méthacrylate (PMMA) pour une grande longueur de trajet de LED et de résistance aux UV.
- Alimentation:** Driver inclus sur tous les modèles, facteur de puissance > 0,95. Optionnellement disponible avec driver 1-10V, Dali, driver réglable 5 niveaux sans ligne de commande, double niveau sans ligne de commande, régulation de tête, régulation du mouvement ou driver pour fonctionner à 12VDC.
- Lampes:** Module Osram composé par LED Osram Oslon SSL avec une puissance 25w, 50w et 75w LED. Disponible en 3000°K, 4000°K ou 5700°K. PCB 1.6mm aluminium de haute pureté, peint en blanc et avec des connecteurs rapides.
- Protections** Diode de protection individuelle interne pour chaque LED. Protecteur contre les surtensions 4KV en standard et 10KV sur demande.
- Durée de vie estimée:** L70B50 60.000 heures.
- Installation:** Sur la colonne ou le poteau, luminaire réglable. Ø 60mm. (Autres dimensions sur demande). Un connecteur électrique rapide de 3 ou 5 pôles, IP66, nous permet installer le luminaire sans ouverture.
- Temp. Ambient.:** -20 À 40 ° C. Il peut être commandé avec sonde de température NTC.
- Colours:** RAL 7012 (gris). Autres couleurs RAL disponibles sur demande.



Ecodut K1 - Symmetric optics 150° Ecodut K1 - Symétrique optical 150°



Includes driver and LED lamp
Comprend lampe LED et drive

Ref.	Colour / Couleur	Lum.	W	€	RAEE lum.
3380 58 25 85	Gray / Gris	3444	25W	384,90	0,60
3380 58 50 85	Gray / Gris	6314	50W	414,90	0,60
3380 58 75 85	Gray / Gris	9184	75W	473,90	0,60

* Standardly supplied with 5700°K LED lamp.
* En standard fourni avec lampe 5700° K LED.

OPTIONS LED

	Ref. AMB	Ref. 83	Ref. 84	Ref. 85
CRI>70 / Colour temp. / Temp. de couleur	Amber/Ambre	3000°K	4000°K	5700°K
Lum 25w	2352	2940	3150	3444
Lum 50w	4312	5390	5775	6314
Lum 75w	6272	7840	8400	9184

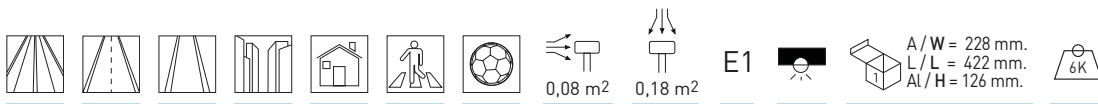
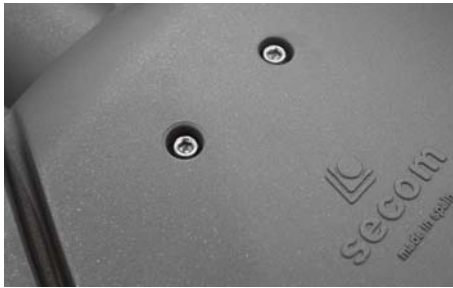

OPTIONS

Rough price increase over the driver / Accessoires		25w	50w	75w
Ref. DR	Dimmable driver 1 - 10v / Driver dimmable 1-10V	31,20	80,00	90,00
Ref. DRD	Dimmable driver Dali / Dimmable driver Dali	82,00	80,00	90,00
Ref. DRPR	Programmable driver / Programmable driver	105,00	80,00	90,00
Ref. DRPNTC	Prog. driver & NTC control / Driver prom. et sonde NTC	110,60	110,60	110,60
Ref. DN	Double level dimmable / Double dimmable de niveau	40,00	42,00	160,00
Ref. DRC	Regulation at the head / Règlement en tête	105,00	80,00	90,37
Ref. DMR8	Regulation at the head / Règlement en tête	75,00	137,00	137,00
Ref. 4160	Driver for 12Vdc operation / Driver pour la fonction. 12Vdc	15,00	25,00	-

Rough price increase of optics / Augmentation par optique		25w	50w	75w
Ref. 3408	Symmetric optics 80° / Optique symétrique 80°	3,20	4,80	4,90
Ref. 3407	Asymmetric optics 150° / Optique asymétrique 150°	38,90	38,90	38,90
Ref. 3407 3408	Asymmetric optics 80° / Optique asymétrique 80°	38,90	38,90	38,90
Ref. 3405	Asymmetric optics Street / Optique asymétrique Street	78,10	78,10	78,10
Ref. AMB	Amber LED / Ambre LED	19,90	39,80	59,70

Rough price increase of accessories / Accessoires		€
Ref. IK10	Impact protection index / Indice de protection anti-vandalismo	8,00
Ref. II	Class II / Classe II	48,00
Ref. AM	Special paint marine environment / Peinture spéciale environnement marin	45,00
Ref. 3390	Surge protector / Protection contre les surtensions	19,00
Ref. 6033	Reducing adapter from 60mm. to 33mm. / Réduire l'adaptateur de 60 mm. à 33mm.	38,00
Ref. 6048	Reducing adapter from 60mm. to 48mm. / Réduire l'adaptateur de 60 mm. à 48mm.	41,00
Ref. 6076	Reducing adapter from 60mm. to 76mm. / Réduire l'adaptateur de 60 mm. à 76mm.	43,00

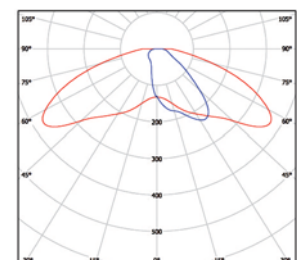
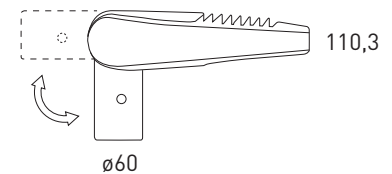
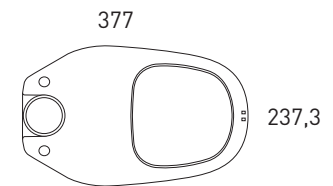

Ref. 3405 Asymmetric optical Street
Optique Asymétrique Street

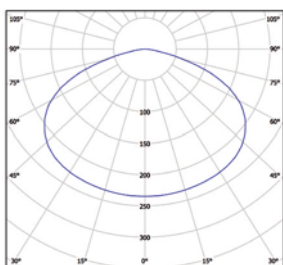

Symmetric optical 150°
Optique symétrique 150°

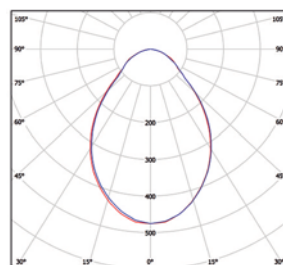

Ref. 3408 Symmetric optical 80°
Optique symétrique 80°

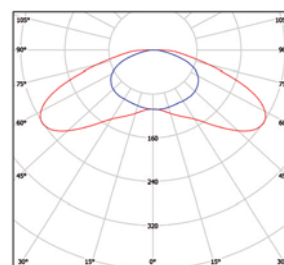

Ref. 3407 Asymmetric optical 150°
Optique asymétrique 150°

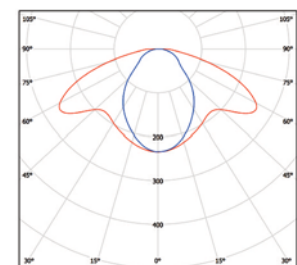

Ref. 3408 3407 Asymmetric optical 80°
Optique Asymétrique 80°

Ecodut K2 LED

Protection degree **IP66** / Impact protection index **IK08**

Material:	Body made of injected aluminum, thermo painted
Optics:	LED lamps include 80°/150° optics. Included waterproof polycarbonate with UV protection.
Supply:	Driver included for all models. Optionally supplied with 1-10V dimmable driver, Dali dimmable driver or programmable dimmable driver.
Lamps:	Module composed by Oslon SLL Osram LED with a total power of 30w, 50w, 70w, 100w, 150w and 200w. Standardly supplied with a temperature of 5700°k. It can be optionally supplied with temperatures of 3000°K and 4000°k. Colour rendering index superior than 80 (CRI> 80).
Lifespan:	Estimated Average Life span 60.000 hours.
Installation:	Column, crossier or intermediet of ø60mm. One quick connector of 3 or 5 poles allows the installation without opening the luminaire.
Ambient temp.:	-20 to 40°C.
Colours:	Sable gray. It can be supplied in other RAL colours by request.

Ecodut K2 LED

Degré de protection **IP66**/ Indice de protection anti-vandalisme **IK08**

Matériel:	Corps en aluminium injecté, thermo peint.
Optique:	Les lampes LED comprennent 80° / 150 ° optique options. Inclus polycarbonate étanche avec protection UV.
Alimentation:	Driver inclus pour tous les modèles. Éventuellement fourni avec 1-10V dimmable pilote, Dali conducteur dimmable ou le conducteur dimmable programmable
Lampes:	Module composé par Oslon SLL Osram LED avec une puissance totale de 30w, 50w, 70w, 100w, 150w et 200w. En standard fourni avec une température de 5700 ° K. Il peut être éventuellement fournie avec des températures de 3000 ° K et 4000 ° K. Couleur indice supérieur à 80 (CRI> 80) de rendu.
Durée de vie estimée:	Longévité moyenne estimée à 60 000 heures.
Installation:	Colonne, crosse ou intermediet du Ø60mm. Un connecteur rapide de 3 ou 5 pôles permet l'installation sans ouvrir le luminaire.
Temp. Ambient.:	-20 À 40 ° C.
Colours:	Sable gris. Il peut être livré dans d'autres couleurs RAL sur demande.



Ecodut K2 - Symmetric optics 150° Ecodut K2 - Symétrique optical 150°



Includes driver and LED lamp
Comprend lampe LED et drive

Ref.	Colour / Couleur	Lum.	W	€
3370 58 30 85	Gray / Gris	5040	30W	459,90
3370 58 50 85	Gray / Gris	6446	50W	479,90
3370 58 70 85	Gray / Gris	8820	70W	510,90
3370 58 10 85	Gray / Gris	13545	100W	587,70
3370 58 15 85	Gray / Gris	20160	150W	677,70
3370 58 20 85	Gray / Gris	27090	200W	782,70

* Standardly supplied with 5700°K LED lamp.
* En standard fourni avec lampe 5700° K LED.

OPTIONS LED	Ref. 83	Ref. 84	Ref. 85	
CRI>80 / Colour temp. / Temp. de couleur	Amber/Ambre	3000°K	4000°K	5700°K
Lum 30w	2744	4200	4592	5040
Lum 50w	3920	5660	6030	6446
Lum 70w	5488	7350	8036	8820
Lum 100w	8232	11287	12341	13545
Lum 150w	12544	16800	18368	20160
Lum 200w	20384	22575	24682	27090

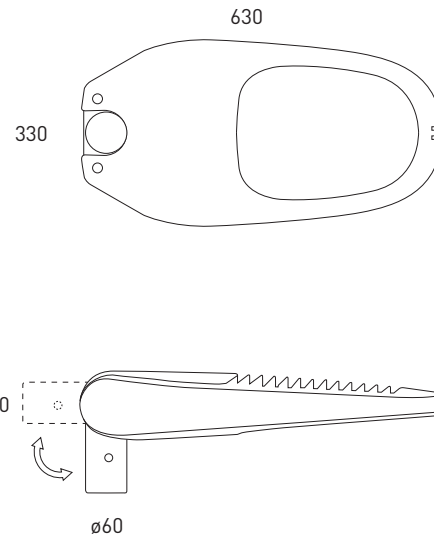

Video Installation
Vidéo d'installation

W/L = 340 mm.
L/L = 780 mm.
H/H = 140 mm.

OPTIONS

Rough price increase over the driver / Accessoires		30w	50w	70w	100w	150w	200w
Ref. DR	Dimmable driver 1 - 10v / Driver dimmable 1-10V	31,20	80,00	90,00	90,00	95,00	50,00
Ref. DRD	Dimmable driver Dali / Dimmable driver Dali	82,00	80,00	90,00	90,00	95,00	90,00
Ref. DRP	Programmable driver / Programmable driver	105,00	80,00	90,00	90,00	95,00	225,00
Ref. DRPNTC	Prog. driver & NTC control / Driver prom. et sonde NTC	110,60	110,60	110,60	110,60	110,60	240,80
Ref. DN	Double level dimmable / Double dimmable de niveau	40,00	42,00	160,00	-	-	-
Ref. DRC	Regulation at the head / Règlement en tête	105,00	80,00	90,00	90,00	95,00	225,00
Ref. DMR8	Motion detector / Détecteur de mouvement	75,00	137,00	137,00	137,00	152,00	120,00
Ref. 4160	Driver for 12Vdc operation / Driver pour la fonction. 12Vdc	15,00	-	25,00	-	-	-



Rough price increase of accessories / Accessoires		€
Ref. IK10	Impact protection index / Indice de protection anti-vandalismo	12,00
Ref. II	Class II / Classe II	48,00
Ref. AM	Special paint marine environment / Peinture spéciale environnement marin	90,00
Ref. 3390	Surge protector / Protection contre les surtensions	19,00
Ref. 6033	Reducing adapter from 60mm. to 33mm. / Réduire l'adaptateur de 60 mm. à 33mm.	38,00
Ref. 6048	Reducing adapter from 60mm. to 48mm. / Réduire l'adaptateur de 60 mm. à 48mm.	41,00
Ref. 6076	Reducing adapter from 60mm. to 76mm. / Réduire l'adaptateur de 60 mm. à 76mm.	43,00

Rough price increase of optics / Augmentation par optique		30w	50w	70w	100w	150w	200w
Ref. 3408	Symmetric optics 80° / Optique symétrique 80°	3,20	4,80	4,90	5,00	5,10	5,20
Ref. 3407	Asymmetric optics 150° / Optique asymétrique 150°	38,90	38,90	38,90	55,60	89,50	122,60
Ref. 3407 3408	Asymmetric optics 80° / Optique asymétrique 80°	38,90	38,90	38,90	55,60	89,50	122,60
Ref. 3405	Asymmetric optics Street / Optique asymétrique Street	78,10	78,10	78,10	105,60	149,90	198,60
Ref. AMB	Amber LED / Ambre LED	19,90	39,80	59,70	79,60	119,40	159,20

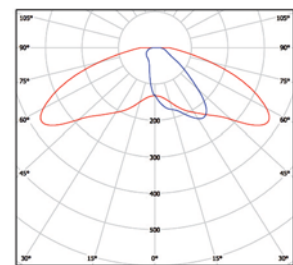

Ref. 3405 Asymmetric optical Street
Optique Asymétrique Street

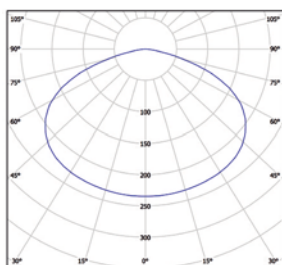

Symmetric optical 150°
Optique symétrique 150°

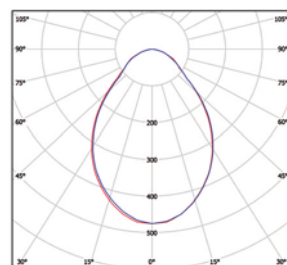

Ref. 3408 Symmetric optical 80°
Optique symétrique 80°

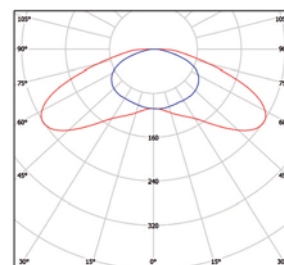

Ref. 3407 Asymmetric optical 150°
Optique asymétrique 150°

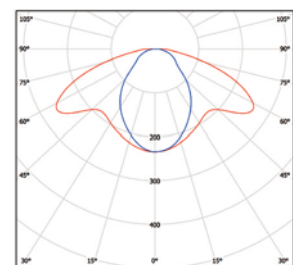

Ref. 3408 3407 Asymmetric optical 80°
Optique Asymétrique 80°

Auris LED

Protection degree **IP65** / Impact protection index **IK08**

Material:	Body made of injected aluminum, thermo painted.
Optics:	Opal polycarbonate diffuser that provides UV protection Uniform illumination over the entire surface.
Supply:	Driver with IP65 included for all models. Optionally supplied with 1-10V dimmable driver, Dali dimmable driver or programmable dimmable driver.
Lamps:	Osram LEDs Module composed by Duris E5 with a total power of 30W, 40W and 60W. Comes standard with a temperature of 5700°K. It can be optionally supplied with temperatures of 3000°K and 4000°K. Chromatic reproduction index higher to 80 (CRI > 80).
Lifespan:	Estimated Average Life span 50.000 hours.
Installation:	To mount on post or column of Ø60mm. One quick connector of 3 or 5 poles allows the installation without opening the luminaire.
Ambient temp.:	-20 to 40°C.
Colours:	Luminaire in gray. It can be supplied in other RAL colours by request.



Auriss LED

Includes driver and LEDs lamp / [Comprend driver et lampes Leds](#)

Ref.	Colour / Couleur	Lumens	W	€
4190 58 30 85	Gray / Gris	3000	30w	449,80
4190 58 40 85	Gray / Gris	4000	40w	469,90
4190 58 60 85	Gray / Gris	6000	60w	528,60

* Standardly supplied with 5700° K LED lamp.

* En standard fourni avec lampe 5700° K LED.

OPTIONS LED	Ref. 83	Ref. 84	Ref. 85
CRI>80 / Colour temperature / Température de couleur	3000°K	4000°K	5700°K
Lum 30w	2850	3000	3000
Lum 40w	3800	4000	4000
Lum 60w	5700	6000	6000

Rough price increase of accessories / Accessoires		€
Ref. AM	Special paint marine environment / Peinture spéciale environnement marin	90,00
Ref. 3390	Surge protector / Protection contre les surtensions	19,00
Ref. 6033	Reducing adapter from 60mm. to 33mm. / Réduire l'adaptateur de 60 mm. à 33mm.	38,00
Ref. 6048	Reducing adapter from 60mm. to 48mm. / Réduire l'adaptateur de 60 mm. à 48mm.	41,00
Ref. 6076	Reducing adapter from 60mm. to 76mm. / Réduire l'adaptateur de 60 mm. à 76mm.	43,00

Auriss LED

Degré de protection **IP65** / Indice de protection anti-vandalisme **IK08**

Matériel:	Corps fabriqué en aluminium injecté avec une couverture de peinture au four.
Optique:	Diffuseur opale de polycarbonate avec protection UV qui proportionne un éclairage homogène de toute la superficie.
Alimentation:	Driver IP65 inclus dans tous les modèles. Il peut être fourni optionnellement avec driver réglable 1-10V, driver réglable Dali ou driver réglable programmable.
Lampes:	Modules composés par LEDs Osram Duris E5, avec une puissance totale de 30W, 40W et 60W. Il est fourni de manière standard avec une température de 5700°K. Il peut être fourni optionnellement avec des températures de 3000°K et 4000°K. Indice de reproduction chromatique supérieur à 80 (CRI>80).
Durée de vie estimée:	Vie utile moyenne de 50.000 heures.
Installation:	Sur colonne ou crosse de 60mm de diamètre. Un connecteur rapide de 3 ou 5 pôles permet d'installer l'éclairage sans nécessité de l'ouvrir. IP65.
Temp. Ambient.:	-20°C à 40°C.
Colours:	Corps de l'éclairage en couleur gris. Disponible en d'autres couleurs RAL basse demande.

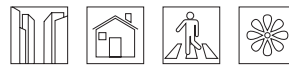

Rough price increase over the driver / [Accessoires](#)

		30w	40w	60w
Ref. DR	Dimmable driver 1 - 10v / Driver dimmable 1-10V	31,20	80,00	90,00
Ref. DRD	Dimmable driver Dali / Dimmable driver Dali	82,00	80,00	90,00
Ref. DRP	Programmable driver / Programmable driver	105,00	80,00	-
Ref. DRPNTC	Prog. driver & NTC control / Driver prom. et sonde NTC	110,60	110,60	-
Ref. DN	Double level dimmable / Double dimmable de niveau	40,00	42,00	160,00

Auris LED suspension

Protection degree **IP65** / Impact protection index **IK08**

Material:	Body made of injected aluminum, thermo painted.
Optics:	Opal polycarbonate diffuser that provides UV protection Uniform illumination over the entire surface.
Supply:	Driver with IP65 included for all models. Optionally supplied with 1-10V dimmable driver, Dali dimmable driver or programmable dimmable driver.
Lamps:	Osram LEDs Module composed by Duris E5 with a total power of 30W, 40W and 60W. Comes standard with a temperature of 5700°K. It can be optionally supplied with temperatures of 3000°K and 4000°K. Chromatic reproduction index higher to 80 (CRI > 80)
Lifespan:	Estimated Average Life span 50.000 hours.
Installation:	To mount on post or column of Ø60mm. One quick connector of 3 or 5 poles allows the installation without opening the luminaire.
Ambient temp.:	-20 to 40°C
Colours:	Luminaire in gray. It can be supplied in other RAL colours by request.

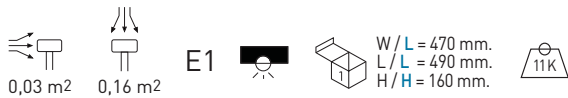
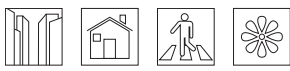

Auris LED

Includes driver and LEDs lamp / *Comprend driver et lampes Leds*

Ref.	Colour / Couleur	Lumens	W	€
4190 58 30 85	Gray / Gris	3000	30w	469,40
4190 58 40 85	Gray / Gris	4000	40w	489,20
4190 58 60 85	Gray / Gris	6000	60w	569,90

* Standardly supplied with 5700° K LED lamp.
* En standard fourni avec lampe 5700° K LED.

OPTIONS LED	Ref. 83	Ref. 84	Ref. 85
CRI>80 / Colour temperature / <i>Température de couleur</i>	3000°K	4000°K	5700°K
Lum 30w	2850	3000	3000
Lum 40w	3800	4000	4000
Lum 60w	5700	6000	6000

Auris LED suspension

Degré de protection **IP65** / Indice de protection anti-vandalisme **IK08**

Matériel:	Corps fabriqué en aluminium injecté avec une couverture de peinture au four.
Optique:	Diffuseur opale de polycarbonate avec protection UV qui proportionne un éclairage homogène de toute la superficie.
Alimentation:	Driver IP65 inclus dans tous les modèles. Il peut être fourni optionnellement avec driver réglable 1-10V, driver réglable Dali ou driver réglable programmable.
Lampes:	Modules composés par LEDs Osram Duris E5, avec une puissance totale de 30W, 40W et 60W. Il est fourni de manière standard avec une température de 5700°K. Il peut être fourni optionnellement avec des températures de 3000°K et 4000°K. Indice de reproduction chromatique supérieur à 80 (CRI>80).
Vie utile:	Vie utile moyenne de 50.000 heures.
Installation:	Sur colonne ou crose de 60mm de diamètre. Un connecteur rapide de 3 ou 5 pôles permet d'installer l'éclairage sans nécessité de l'ouvrir. IP65.
Temp. Ambient.:	-20°C à 40°C.
Colours:	Corps de l'éclairage en couleur gris. Disponible en d'autres couleurs RAL basse demande.



ACCESSORIES

Rough price increase of accessories / <i>Accessoires</i>	€
Ref. 3390 Surge protector / <i>Protection contre les surtensions</i>	19,00
Ref. AM Special paint marine environment / <i>Peinture spéciale environnement marin</i>	90,00

Rough price increase over the driver / *Accessoires*

		30w	40w	60w
Ref. DR	Dimmable driver 1 - 10v / <i>Driver dimmable 1-10V</i>	31,20	80,00	80,00
Ref. DRD	Dimmable driver Dali / <i>Dimmable driver Dali</i>	82,00	80,00	90,00
Ref. DRP	Programmable driver / <i>Programmable driver</i>	105,00	80,00	90,00
Ref. DRPNTC	Prog. driver & NTC control / <i>Driver prom. et sonde NTC</i>	110,60	110,60	-
Ref. DN	Double level dimmable / <i>Double dimmable de niveau</i>	40,00	42,00	-
Ref. DMR8	Motion detector / <i>Détecteur de mouvement</i>	75,00	137,00	137,00

Kloss City LED

Protection degree **IP65** / Impact protection index **IK09**

- Material:** Body made of polycarbonate. Support in thermo painted Steel sheet.
- Optics:** Opal polycarbonate diffuser that provides UV protection
Uniform illumination over the entire surface.
- Supply:** Driver included in all models. Can be supplied with Dimmable driver 1-10V, Dali Dimmable Driver, surface control of light output and /or presence detector and double level dimmable.
- Lamps:** Osram LEDs Module composed by Duris E5 with a total power of 20W, 42W and 60W. Comes standard with a temperature of 5700°K. It can be optionally supplied with temperatures of 3000°K and 4000°K. Chromatic reproduction index higher to 80 (CRI > 80).
- Lifespan:** Estimated Average Life span 50.000 hours.
- Installation:** Directly to ceiling or pole (not supplied). One quick connector of 3 or 5 poles allows the installation without opening the luminaire.
- Colours:** Luminaire in gray.

Kloss City LED

Degré de protection **IP65**/ Indice de protection anti-vandalisme **IK09**

- Matériel:** Corps fabriqué en polycarbonate y crosse fabriquée en acier avec un recouvrement en époxy polycarbonate cuit au four.
- Optique:** Diffuseur opale méthacrylate avec protection UV qui diffuse un éclairage homogène sur toute sa surface.
- Supply:** Tous les modèles sont équipés de leur appareillage . En option, il peut être fournie avec un DRIVER 1-10V, DRIVER DALI, tête multi-capteur de contrôle de flux lumineux et/ou de présence et kit secours pour LED autonomie de 1h à 3h.
- Lampes:** Modèle équipé de LED OSRAM DURIS E3 avec une puissance total de 20W, 40W et 60W. Composé de manière standard avec une température de 5700°k. En option, il peut être fournie avec une température de 3000°k et 4000°k. Indice de reproduction chromatique supérieur a 80 (CRI 80).
- Lifespan:** Longévité moyenne estimée à 50 000 heures.
- Installation:** Installé directement au plafonds au moyen de 2 clips en acier inoxydable. Ceux ci se fixent au plafonds au moyen de vis (non incluses). Fixation anti-vandalisme en option. Deux connecteurs électriques rapides de 3 ou 5 pôles intégrés pour installation en câblage traversant sans à avoir à ouvrir l'appareil.
- Colours:** Corps du luminaire gris.



Kloss City LED

Includes driver and LED lamp / [Comprend lampe LED et drive](#)

Ref.	Color / Colour	Lumens	W	€
4165 58 20 85	Gray / Gris	2100	20w	255,40
4165 58 42 85	Gray / Gris	4200	42w	284,90
4165 58 60 85	Gray / Gris	6300	60w	308,90

* Standardly supplied with 5700°K LED lamp.

* En standard fourni avec lampe 5700° K LED.

OPTIONS LED	Ref. 83	Ref. 84	Ref. 85
CRI>80 / Colour temperature / Température de couleur	3000°K	4000°K	5700°K
Lum 20w	1900	2000	2100
Lum 42w	3800	4000	4200
Lum 60w	5700	6000	6300

ACCESSORIES

Rough price increase of accesories / Accessoires	€
Ref. 3390 Surge protector / Protection contre les surtensions	19,00
Ref. AM Special paint marine environment / Peinture spéciale environnement marin	70,00

Rough price increase over the driver / Accessoires	20/40w	60w
Ref. DR Dimmable driver 1 - 10v / Driver dimmable 1-10V	80,00	90,00
Ref. DRD Dimmable driver Dali / Dimmable driver Dali	80,00	90,00
Ref. DRP Programmable driver / Programmable drive	80,00	-
Ref. DRDNTC Prog. driver & NTC control / Driver prom. et sonde NTC	110,60	-

INSTALLATION RECOMMENDATIONS RECOMMANDATIONS D'INSTALLATION

FUNCTIONAL SIMBOLOGY FONCTIONNELLE DU SYMBOLOGIE

STREET LIGHTING / L'ÉCLAIRAGE DES RUES



Highways / **Autoroutes**



Roads / **Routes**



Service ways / **Façons de services**



Tunnels / **Tunnels**

URBAN LIGHTING / ECLAIRAGE URBAIN



Streets and Avenues / **Rues et Avenues**



Residential / **Résidentiel**



Pedestrian ways / **Des chemins piétonniers**



Parks and gardens / **Parcs et jardins**



Monumental illumination / **Illumination Monumental**



Sign lighting / **Sign lighting**

BIG AREAS LIGHTING ÉCLAIRAGE DE GRANDS DOMAINES



Outdoor sports zones / **Sports éclairage intérieur**



Big surfaces / **Grandes surfaces**



Sports indoor lighting / **Sports éclairage intérieur**



Parking zones / **Zones de stationnement**



Industrial / **Industriel**



Departments stores / **Grands magasins**



Shopping malla / **Commercial**

SIMBOLOS TÉCNICOS TECHNICAL SIMBOLOGY



Surface exposed to wind (horizontal)
Surface exposée au vent (horizontal)



Surface exposed to wind (vertical)
Surface exposed to wind (vertical)



Short light pollution
Short light pollution

FHS

Upper hemisphere flow from total effective flow

L'écoulement dans l'hémisphère supérieur de l' effectif global.

Light percentage produced produced in the focus that is projected to the sky from the horizon level, which is lost light.

Pourcentage de la lumière produite produite dans l'orientation qui est projetée dans le ciel du niveau de l'horizon, la lumière qui est perdue.

E1	<1%
E2	1% - 5%
E3	5% - 15%
E4	15% - 25%



Width - **Largeur** = W / L
Length - **Longueur** = L / L
Height - **Hauteu** = H / H



Weight
Poids

LCS LIGHT CONTROL SOLUTION

Bluetooth 4.0

Smart lighting control device with Bluetooth 4.0 via smartphone or tablet.

Dispositif intelligente d'éclairage contrôlé par Bluetooth 4.0 depuis votre smartphone ou tablette.

With LCS device you can control your lights for different types of lighting. Regulate light intensity, adjust color (RGB), set it through a simple and intuitive application. Enjoy a new experience generating different types of environments and achieving greater savings through your smartphone or tablet.

Avec le dispositif LCS vous pouvez contrôler vos lumières pour différents types d'éclairage. Réglementer l'intensité lumineuse, ajuster la couleur (pour RGB), configuration selon vos besoins avec une application simple et intuitive. Profitez d'une nouvelle expérience en générant différents types d'environnements et en obtenant des grandes économies grâce à votre smartphone ou tablette.



Casambi is an application of wireless control for LED lighting. Free download app, available for Android and Apple.

Casambi est une application de contrôle sans fil pour lumières LED. Téléchargement gratuit, disponible pour Android et Apple.

Visual and intuitive application.

Control your lights through your smartphone or tablet.



Application Visuelle et intuitive.

Contrôler vos lumières avec votre smartphone ou votre tablette.

Everyday practical use.

You can still using your conventional switches.

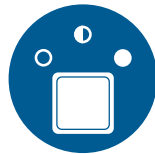

Utilisation quotidienne pratique.

Vous pouvez toujours utiliser vos commutateurs conventionnels.

New experience.

Custom configuration.



Nouvelle expérience.

Configuration personnalisée.

Easy to install.

No need new wiring and switches.



Facile à installer.

Pas besoin de nouveau câblage et de commutateurs.

Security

Password protected so nobody can access to the fixtures.



Sécurité

Protégé par mot de passe pour afin que personne ne puisse y accéder sans votre permission.



LCS Light Control Solution

Bluetooth 4.0

- Device:** Wireless Controller for LED lighting with Dali control. (The lamp has to be equipped with dimmable driver DALI).
Luminaires equipped with LCS technology, allow control multiple luminaires and create or change between scenes. This technology allows a conventional wall switch without the Casambi app if necessary.
- Installation:** Each LCS works as a Bluetooth repeater. You can place a single LCS device for luminaire if you want an individual control, while allowing to bunch in zones or place an LCS device to control up to 10 fixtures by connecting wires for DRD (Ref. 3420).
Input voltage: 220-240V.
Maximum power: 100W per luminaire with an LCS device and up to 500w with LCS device and 9 connecting wires (3420 Ref.).
- Alcance:** Indoor: maximum 30 m.
Outdoor: maximum 50 m.

LCS Light Control Solution

Bluetooth 4.0

- Dispositif:** Wireless Controller pour éclairage LED avec régulation DALI. (La lampe doit être équipée avec un DRIVER DALI).
Les luminaires équipés de LCS régulent et contrôlent plusieurs luminaires, et créent ou modifient entre les scènes.
Cette technologie permet un interrupteur mural classique sans l'application Casambi si nécessaire.
- Installation:** Chaque LCS agit comme un répéteur Bluetooth. Vous pouvez placer un dispositif LCS par luminaire, pour un contrôle individuel. Ce dispositif nous permet aussi de grouper en zones ou de placer un dispositif LCS pour contrôler jusqu'à 10 appareils par câbles de raccordement pour DRD (Ref. 3420).
Tension d'alimentation: 220-240V.
Puissance maximale: 100W par luminaire avec un dispositif de LCS et jusqu'à 500W avec un dispositif LCS plus 9 câbles de connexion (3420 Réf.).
- Champ d'application:** Intérieur : 30m max. ; Extérieur: 50m max.

LCS Bluetooth 4.0 device

LCS Bluetooth 4.0 dispositif

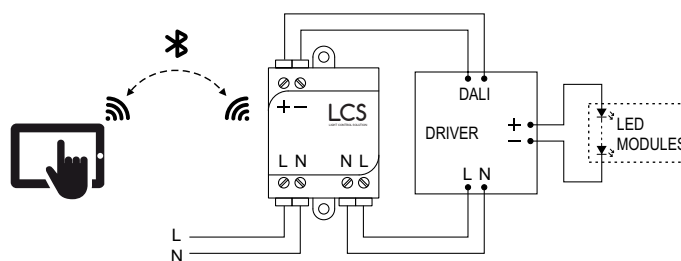
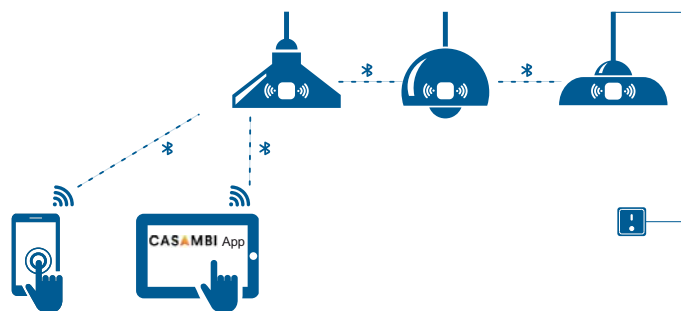
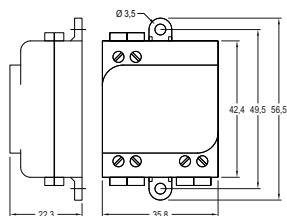

LCS Light Control Solution

Bluetooth 4.0 Device / Bluetooth 4.0 dispositif

Ref.	Description	Power/Puissance	Dimmable/Règlement	€
LCS	LCS Device/Dispositif/ Bluetooth	5-100w	DALI	199,90

- * Available for all SECOM LED luminaires from 5w to 100 w.
* Luminaire must be equipped with dimmable driver Dali (DRD).

- * Disponible pour tous les luminaires SECOM LED 5-100 w.
* Le luminaire doit être équipé d'un Driver réglable Dali (DRD).

ACCESSORIES /ACCESSOIRES

Ref.	Description	€
3420	Wire connector for DRD / Câble de connexion pour DRD	9,60

- * Connection wires (Ref. 3420) allow perfect synchronization of LED lights (master can control up to nine slaves, each slave can have a maximum power of 50W).

- * Les câbles de connexion (Ref. 3420) permet une parfaite synchronisation de lumières LED (un maître peut contrôler jusqu'à neuf esclaves, chaque esclave ne peut pas avoir une puissance supérieure à 50W).

Download your free application and begins to control your lighting.

Téléchargez votre application gratuite et commence à contrôler votre éclairage.

App **CASAMBI**

User manual
Manuel de l'utilisation



Terms and conditions of sale / Conditions de Vente

1. General.

SECOM S.L. reserves the right to perform modifications on the measures and characteristics of the fittings, improvements on his models, and to eliminate the supply of any of them without previous notice.

SECOM S.L. is not responsible of any problems caused by possible mistakes in the pictures, measures and/or data which appear in the catalogue.

2. Guarantees.

Guarantees are valid from the date of receipt of the product. You must show the commercial invoice as proof and reception document where appropriate.

SECOM S.L. is responsible for the quality of its luminaires provided the above recommendations are followed and declines all responsibility for:

- Inappropriate storage or installation.
- Incorrect use.
- Modifications in the products after the sale.
- Incorrect power supply.
- Conditions due to the use of cleaning products contradictory with the indicated ones.
- Logical Deterioration by the passage of time, cuts, scratches or damage caused by impacts or accidents.
- External agents.

All cases of claims for hidden defects be attended in accordance with Real Decreto Legislativo 1/2007 of 16 November, approving the revised text of the Ley General para la Defensa de los Consumidores y Usuarios and other complementary laws (RDL 1/2007 from now on).

Luminaires are subject to the guarantee period established in RDL 1/2007, all products have a 2 year manufacturer's guarantee from date of delivery of the product unless a longer period of time is established.

The durability of the luminaries depends on:

Stainless Steel Products: Stainless steel products of this catalog are made of high quality material.

On stainless steel small stains resulting from contact with marine atmosphere, humid environments, as well as lime water from irrigation may occur. This type of contamination on steel will be removed with an application of cleaning products containing phosphoric acid.

Aluminium products: Our products have been protected with chromate and finished with polyester paints and deterioration can occur by:

Ongoing contact with water with high percentage of salt or acidified water contaminated by fertilizers or insecticides.
Electrolysis produced by the contact of aluminium with screws if they are iron made (stainless steel are recommended).
The existing current in the ground, only avoidable with proper earth connection.
Non fast protection of aluminium in the event of the painting has been torned by abrasion or shock.

The responsibility of SECOM S.L. it is limited to the delivery of the components that have suffered a malfunction (PCB Led plates, driver, etc.), not being extensible to other expenses such liability that may result from the replacement of components that have suffered a malfunction, such as transport costs, accommodation, travel, cost of the labor hours, trucks, cranes, machinery, diets, etc., or any other direct or indirect damage or injury such as loss of profits.

In the event the customer prefers that the components that have suffered malfunctions are repaired by SECOM LIGHTING, S.L. luminaires must send prepaid. SECOM LIGHTING, S.L. proceed to the replacement of components as quickly as possible and the manufacturer will deliver the luminaires in perfect running order with customer freight collect conditions.

1. Généralités.

SECOM S.L. se réserve le droit d'effectuer des modifications sur les mesures et les caractéristiques des raccords, des améliorations sur ses modèles, et d'éliminer la fourniture de l'un d'eux sans préavis.

SECOM S.L. ne est pas responsable de tous les problèmes causés par les erreurs possibles dans les photos, mesures et / ou des données qui figurent dans le catalogue.

2. Garanties.

Les garanties sont valables à partir de la date de réception du produit. Vous devez montrer la facture comme preuve et le document réception de celui-ci, dans son cas.

SECOM.S.L. est responsable de la qualité de ses luminaire à condition que les recommandations ci-dessus sont suivies et décline toute responsabilité pour:

- Stockage ou installation incorrecte.
- Faire Une mauvaise utilisation du luminaire.
- Modification des produits après-vente.
- Alimentation incorrecte.
- Conditions pour l'utilisation de produits de nettoyage non indiqué.
- La détérioration logique dans le temps, des coupures, des éraflures ou des dommages causés par les impacts ou les accidents.
- Agents externes.

Tous les cas de réclamations pour des défauts cachés seront répondues en conformité avec le décret royal législatif 1/2007 du 16 Novembre, où il est approuvé le texte de la loi générale pour la protection des consommateurs et des utilisateurs et d'autres lois complémentaires (ci-après RDL 1 / 2007).

Les luminaires sont soumis à la période de garantie établie à RDL 1/2007, tous les produits ont une garantie du fabricant de 2 ans à partir de la date de livraison du produit, sauf si une période de temps plus longue est établie et venu.

La durabilité des luminaires dépend:

Produits en acier inoxydable: produits de ce catalogue en acier inoxydable sont faits de matériaux de haute qualité.

Sur l'acier inoxydable l'irrigation peut se produire de petites taches, à la suite de contact avec l'atmosphère marine, les milieux humides, ainsi que l'eau de chaux de. Ce type de contamination sur l'acier sera supprimé avec l'application de produits de nettoyage contenant de l'acide phosphorique.

Produits d'aluminium: Nos produits ont été protégées avec chromate et finis avec des peintures de polyester et la détérioration peut se produire par:

- Un contact régulier avec des eaux pourcentage élevé de sel ou de l'eau acide contaminés par les engrais ou insecticides.
- Électrolyse produit par le contact de l'aluminium avec des vis si elles sont le fer (acier inoxydable sont recommandés).
- Le courant existant dans le sol, seulement évitable avec la prise de terre appropriée.
- Non protéger rapidement l'aluminium dans le cas d'être déchirée par la peinture par le toucher ou de choc.

La responsabilité de SECOM S.L. est limitée à l'envoi des composants qui ont souffert d'un dysfonctionnement (PCB plaques LED, driver, etc.), ne pas être extensible, cette responsabilité, les autres charges qui pourraient résulter du remplacement des composants qui ont souffert d'un dysfonctionnement, tels que le transport, l'hébergement, Voyage, coût des heures de travail, les camions, les grues, les machines, les régimes alimentaires etc., ou tout autre dommage ou dommage direct ou indirect tel que; perte de profits.

Dans le cas où le client préfère que les composants qui ont subi des dysfonctionnements sont réparés par SECOM ÉCLAIRAGE, S.L. vous devez envoyer luminaires pour leurs moyens. SECOM ÉCLAIRAGE, S.L. procédera au remplacement des composants le plus rapidement possible et enverra les lumières dans parfait état de fonctionnement.

3. Delivery time.

The delivery time will be confirmed at the time of placing the order and will always be as orientative guide, so delays that may exist not imply the cancellation of the order or the imputation of penalties.

4. Transport.

In the case of abroad delivery the transport will be charged to SECOM S.L. for orders upper to 800 € for Italy, 1.000 € for France, 400 € for Portugal. (For other destinations ask conditions) However the customer can choose to nominate his agency, but in that case, even if the total amount of the order is upper to the minimum, the client will be totally responsible for the amount of transport.

5. Claims.

Claims for difference in quantity, quality or other types of defect/fault of the delivered goods will not be accepted after 24 hours from the delivery date.

Claims for breakages of the material due to the transport agency will not be admitted alter 24 hours, as it is the maximum time allowed for the insurance companies.

6. Returns.

SECOM S. L. not accept any return of goods that has not previously been reported and accepted in writing by SECOM SL.

All returns must have included the following documentation:

- List of material or product returned
- Cause or reason for return
- A copy of the invoice for the purchase of material or product

No standard items returns will not be accepted.

The final decision will be taken after checking the returned goods.

The returns of material in good condition, will be accepted under the following conditions:

- Antiquity of the material less than 30 days - 20% depreciation
- Between 30 days and 3 months - 30 % depreciation.
- Between 3 and 12 months - 50% depreciation.
- More than 12 months no refunds.

Transport costs for returns will be paid by the customer, except those which may result from causes of defects in quality or errors attributed to SECOM SL, in which case it will be sent by the agency indicated by the area's commercial agent.

7. Cancellation of orders.

Once we receive the Purchase Order, and it's related to customized luminaires or NOT LED fittings and after 48 hours after sending the confirmation, the order could not be cancelled unless written authorization by SECOM.

In case of this authorization, we'll charge 20% of the total amount as depreciation value.

8. Entry into force.

1st of March 2017.

This catalogue/price list nullifies any previous price list.

3. Délai de livraison.

Le délai de livraison sera confirmé au moment de la passation de la commande et de la volonté toujours de guides indicatifs, de sorte retards qui peuvent exister ne implique pas l'annulation de la commande ou l'imputation de pénalités.

4. Transport.

Dans le cas de livraison à l'étranger le transport sera facturé au SECOM SL pour les commandes supérieure à 800 € pour l'Italie, 1,000 € pour la France, 400 € pour le Portugal. (Pour les autres destinations demander conditions) Toutefois, le client peut choisir de nommer son agence, mais dans ce cas, même si le montant total de la commande est supérieure au minimum, le client être totalement responsable de la quantité de transport.

5. Les réclamations.

Les demandes de différence de quantité, la qualité ou d'autres types de défauts / faute de la marchandises livrées ne seront pas acceptées après 24 heures à partir de la date de livraison.

Les demandes de ruptures du matériau en raison de l'agence de transport ne seront pas admis modifier 24 heures, comme ce est le temps maximum autorisé pour les assurances entreprises.

6. Retours.

SECOM SL décline toute restitution des biens qui n'a pas déjà été signalé et accepté par écrit par SECOM SL.

Tous les retours doivent avoir compris la documentation suivante:

- Liste des matériel ou produit retourné
- Cause ou la raison du retour
- Une copie de la facture pour l'achat de matériel ou d'un produit.

Aucun retour de produits standards ne seront pas acceptées.

La décision finale sera prise après avoir vérifié les marchandises retournées.

Les retours de matériel en bon état, seront acceptées en vertu de la suivante conditions:

- Antiquité de la matière à moins de 30 jours - 20% de dépréciation
- Entre 30 jours et 3 mois - 30% de dépréciation.
- Entre 3 et 12 mois - 50% de dépréciation.
- Plus de 12 mois aucun remboursement.

Les coûts de transport pour les retours seront payés par le client, sauf celles qui peut résulter de causes de défauts de qualité ou des erreurs attribuées à SECOM SL, dans ce cas, il sera envoyé par l'agence indiquée par le commercial de la zone l'agent.

7. Annulation de commandes.

Après la réception d'un bon de commande chez nous, soit lumières spéciales ou soit lumières non LED, 48 heures après sa réception, aucune commande pourra être annulé sans autorisation écrite de la société Secom.

Dans le cas où l'annulation soit approuvée, cela occasionnera une pénalité de 20% du total de la commande.

8. Entrée en vigueur.

Le 1 Mars 2017.

Ce tarif, annule et remplace toutes les informations précédentes.

67

According to Art.12 of the Law 11/1997 on packaging and packaging waste, the final holder of packaging waste and used packaging, will be responsible for delivering in an adequate separation conditions for its correct environmental management to a recovery, recycling or authorized valuer.

Selon Art.12 de la loi n ° 11/1997 relative aux emballages et aux déchets d'emballages, le détenteur final des déchets d'emballage et de conditionnement utilisé, sera responsable de fournir à une des conditions de séparation adéquates pour sa bonne gestion environnementale à une récupération, le recyclage ou évaluateur agréé.

© SECOM ILUMINACION S.L.

All rights reserved. Total or partial reproduction without the prior written consent of the copyright owner is prohibited.

Tous les droits sont réservés. La reproduction totale ou partielle, faite sans le autorisation écrite préalable du propriétaire du droit de l'auteur est interdite.

secom
here comes the light



Indoor lighting / Industrial lighting / Outdoor lighting
Eclairage intérieur / Eclairage industriel / Eclairage extérieur

Polígono Industrial La Estrella C/ Marte 18-21
30500 Molina de Segura (Murcia) Spain
Tlf.: 968 801 211 - Fax 968 891 048
Buzón de Correos nº 11
secom@secom.es

Dpto. Exportación
Tlf.: ++34-968 801 688 - Fax: ++34-968 891 048



www.secom.es

