

secom  
here comes the light



# ESDIUM TUNNEL HE

PROYECTOR ALTA EFICIENCIA  
HIGH EFFICIENCY FLOOD LIGHT

[www.secom.es](http://www.secom.es)



# SOLUCIÓN INTEGRAL DE ILUMINACIÓN LIGHTING COMPLETE SOLUTION



Esdium Tunnel LED es una luminaria con un gran rendimiento que garantiza a los conductores, tanto de día como de noche, que sus percepciones visuales no se vean mermadas, haciendo que el nivel lumínico en la entrada o la salida del túnel no varíe demasiado. Esto lo logra gracias a su diseño flexible, a sus diferentes ópticas y a una gran variedad de potencias. De gran robustez y resistencia, fabricado en aluminio inyectado, con cierre de metacrilato transparente (PMMA).

Esdium Tunnel LED is a luminaire with great performance that ensures drivers, at day and night, their visual perceptions are not reduced, causing the light level at the entrance or exit of the tunnel does not change excessively. This is achieved thanks to its versatile design, its different optical and a variety of powers. High strength and resistance, made of cast aluminum, transparent methacrylate closure (PMMA).

## ESDIUM TUNNEL HE

LUMINARIAS PARA TUNEL / LUMINAIRES FOR TUNNEL

Color Base  
Base Colour



58



Disponible en otros colores RAL bajo pedido.  
It can be supplied in other RAL colours by request.

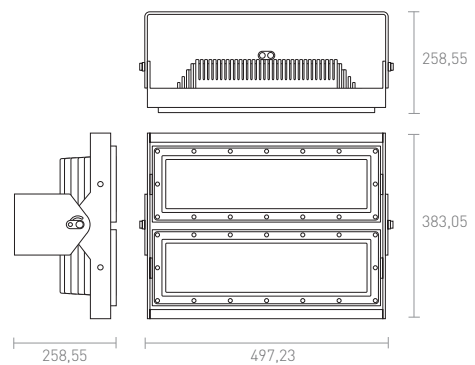
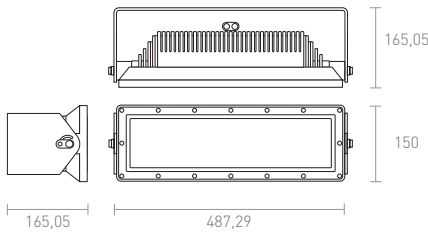
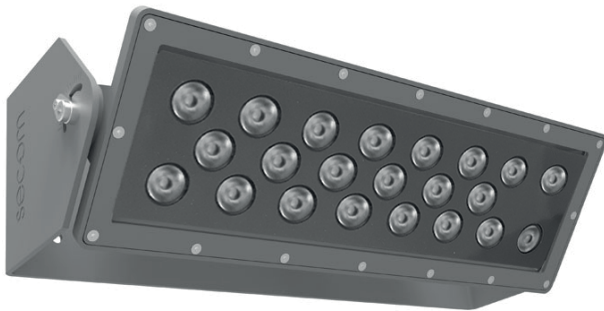
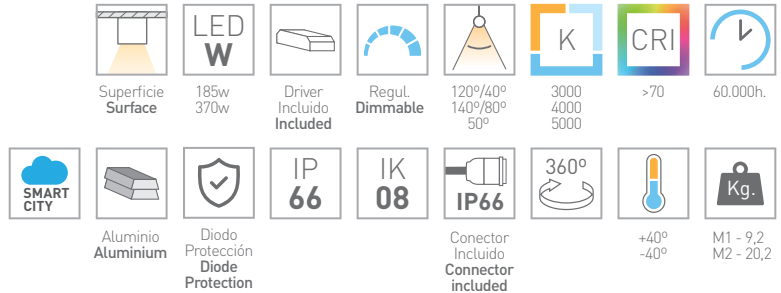

### ESDIUM TUNNEL / ÓPTICA ASIMÉTRICA 2 LADOS / ASYMMETRIC OPTIC 2 SIDES

Ref.	Color / Colour	W	Módulos / Modulo	(83) lm 3000k	(84) lm 4000k	*[85] lm 5000k
3300 58 18 0 85	Gris / Gray	185	M1 (1)	28842	30233	30233
3300 58 37 0 85	Gris / Gray	370	M2 (2)	57684	60466	60466

\*Estándar / \*Standard



Ref. 5

Óptica asimétrica 2 lados 120° log. y 40° transversal a 25°.  
Asymmetric optics 2 sides lengthwise and 40° transversal.

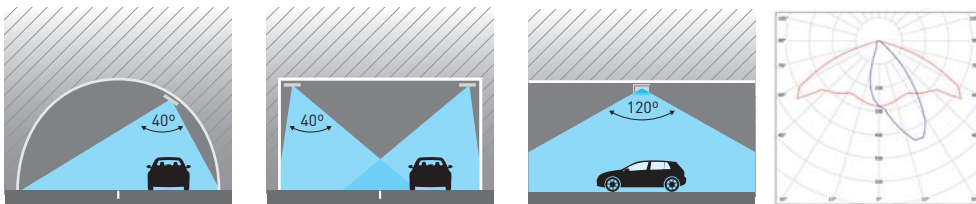

Ref. 6

Óptica asimétrica cenital 140° longitudinal y 80° transversal.  
Aerial asymmetric optic 140° lengthwise and 80° Cross.

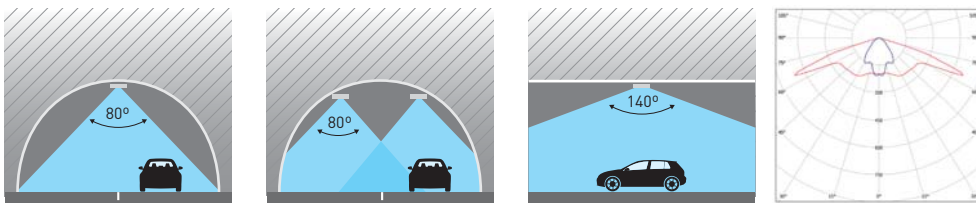

Ref. 7

Óptica asimétrica 50° Counter-beam  
Asymmetric optics 50° Counter-beam

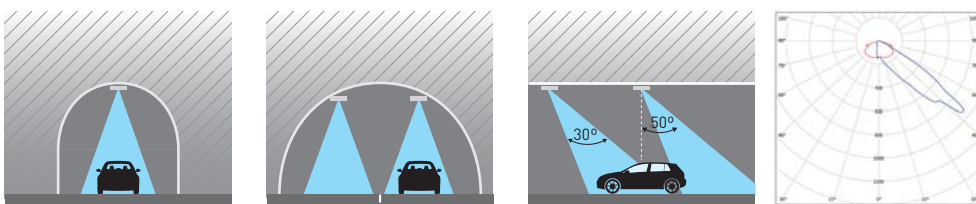

## OPCIONES / OPTIONS

### D ÓPTICAS / OPTICS

Ref.	Descripción / Description
5	Óptica asimétrica 2 lados 120° log. y 40° transversal a 25° Asymmetric optic 2 sides 120° Lengthwise and 40° transversal
6	Óptica asimétrica cenital 140° longitudinal y 80° transversal Aerial asymmetric optic 140° lengthwise and 80° cross
7	Óptica asimétrica 50° Counter-beam Asymmetric optics 50° Counter-beam

### A ACCESORIOS / ACCESSORIES

Ref.	Descripción / Description
AM	Pintura especial ambiente marino / Special marine environment paint
IK10	Índice de protección antivandálico / Special marine environment paint

### D DRIVER

Ref.	Descripción / Description
DR	Driver regulable 1-10 / Driver dimmable 1-10v
DRD	Driver regulable Dali / Driver dimmable Dali
DRPR	Driver programable / Driver dimmable

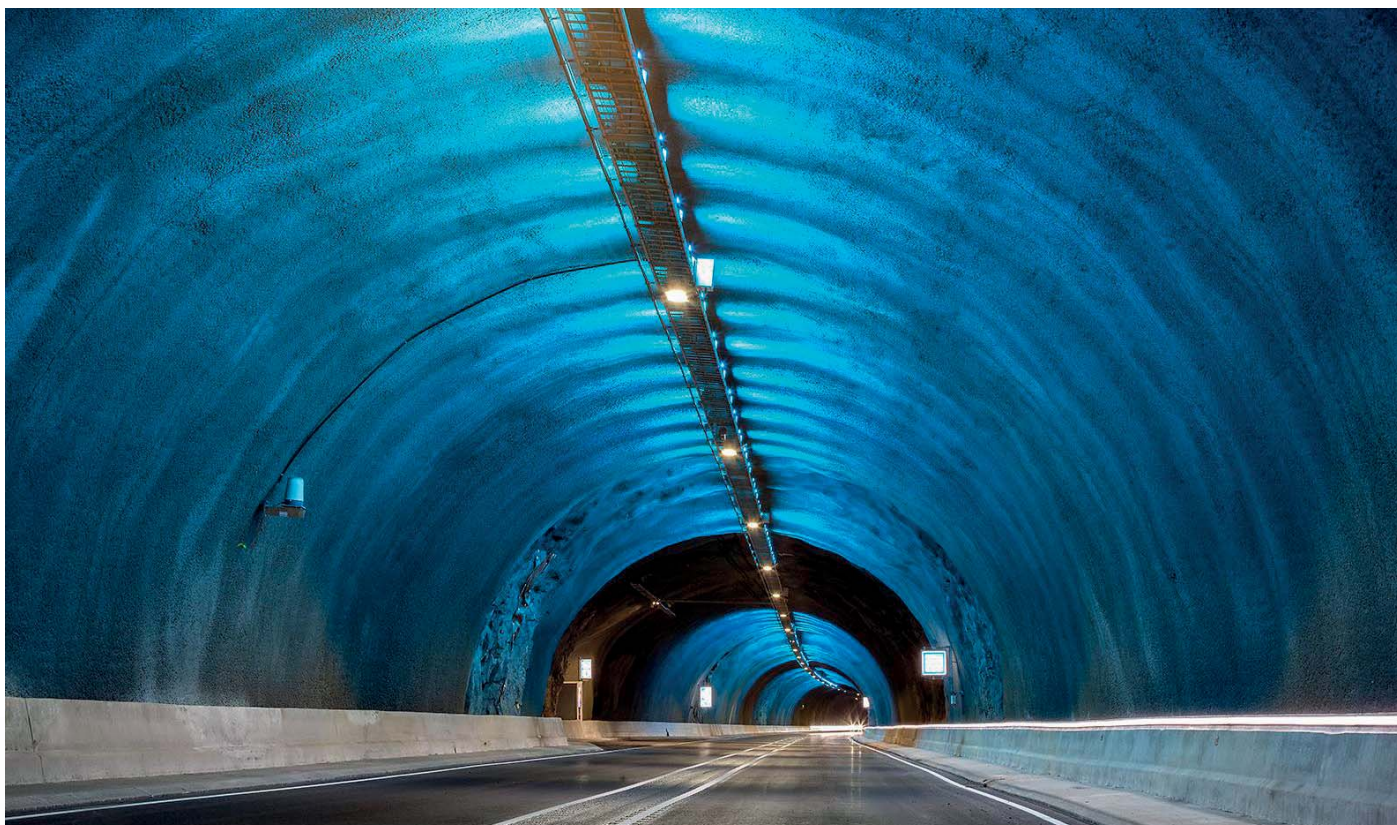

Los beneficios de las luminarias de LEDs de secom.

Ahorro energético por su alta eficiencia.

Ahorro en mantenimiento de luminarias.

Reproducción cromática (IRC) 80.

Amplia gama en temperaturas de color.

Amplia gama de medidas y de colores.

Posibilidad de regular las luminarias.

Ópticas de alto rendimiento.

Fácil montaje e instalación.

¿Por qué trabajar con secom?

Fabricación nacional de todas sus luminarias de LEDs.

Disponibilidad de todos los componentes de las luminarias de LEDs (disipadores, LEDs, circuitos, drivers, etc) para reposición.

El mejor servicio en luminarias de LEDs, debido a la fabricación nacional y al gran stocks de componentes.

Gran versatilidad en diseño, posibilidad de personalizar luminarias.

Productos que cumplen la normativa europea vigente.

LEDs Osram / Samsung.

Estricto control de calidad.

Gran inversión en I+D+i para el desarrollo de flujos lumínicos y tecnologías de disipación de temperatura.

PCB con fechador para verificar la vida media útil garantizada.

The benefits of secom LED lighting fittings.

Energy-saving because of his high efficiency.

Saving in maintenance.

Cromatic reproduction (ICR) 80.

Wide range of colour temperature.

Wide range of measures and colours.

Possibility of dimming the lighting fitting.

High output optics.

Easy installation.

Why should you work with secom?

Own production of all our LED light fitting.

Availability of all components of LEDs fittings (heat sink, LEDs, drivers, etc.) for replacement.

The best service in the LEDs fitting due to the production in our own production plants of and a large stock of components.

Flexibility in design and possibility of customize the fittings.

The products comply with European standards.

Components are Osram / Samsung.

Strict quality control.

Big investment in R&D on development of luminus fluxes and temperature dissipation technologies.

PCB with its production date for life span control.



**secom**

here comes the light

Polígono Industrial La Estrella. C/ Marte 18-21.  
30500 Molina de Segura. Murcia. Spain  
Tlf. 968 80 12 11 / Fax 968 89 10 48  
secom@secom.es

Dpto. Exportación.  
Tlf. +34-968-80 18 00  
Fax. +34-968-89 10 48  
export@secom.es



www.secom.es

