

secom
here comes the light

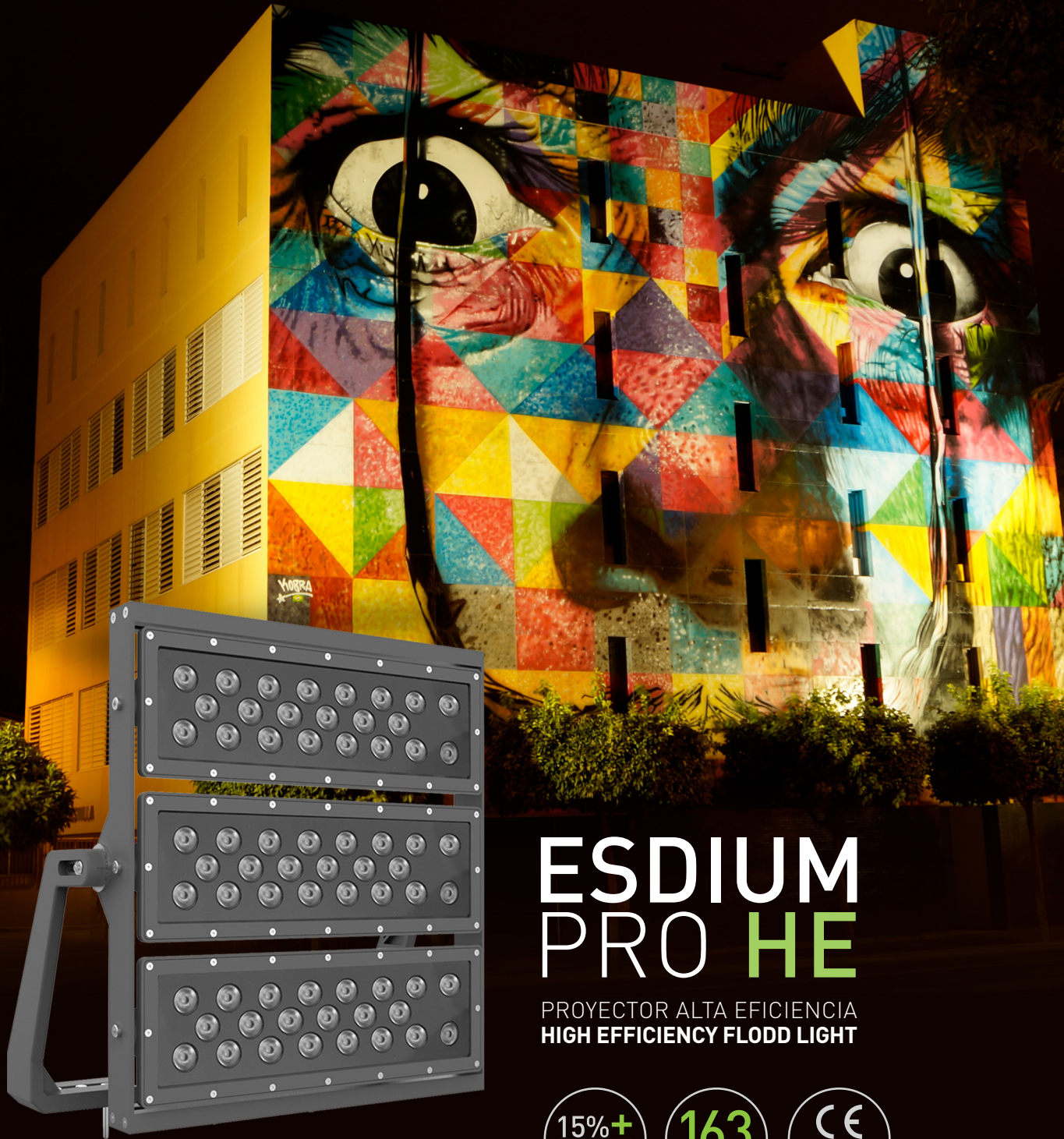

ESDIUM PRO HE

PROYECTOR ALTA EFICIENCIA
HIGH EFFICIENCY FLOOD LIGHT

15%+
EFICIENTE
EFFICIENT

163
lm./w

CE
MADE IN
SPAIN

www.secom.es



ESDIUM PRO HE

PROYECTOR ALTA EFICIENCIA

ESDIUM PRO HE LED, LUMINARIA DE ALTA EFICIENCIA que ofrece un gran rendimiento para cualquier tipo de instalaciones.

Su gran desarrollo y versatilidad, nos permite la colocación en espacios que se requieran grandes paquetes lumínicos, a la vez que bajas pérdidas de luminosidad gracias a sus diferentes lentes.

La innovación de Esdium Sport HE LED le permite ser orientada de una manera muy precisa, con marcador de ángulo y módulos orientables individuales.

Fabricado en aluminio inyectado de alto rendimiento, con cierre de metacrilato (PMMA), LEDs de alto rendimiento y ópticas adecuadas para cada uno de los proyectos necesarios, convirtiéndola en una luminaria de gran robustez y resistencia.

HIGH EFFICIENCY FLODD LIGHT

ESDIUM PRO HE LED, LUMINARIA DE ALTA EFICIENCIA que ofrece un gran rendimiento para cualquier tipo de instalaciones.

Su gran desarrollo y versatilidad, nos permite la colocación en espacios que se requieran grandes paquetes lumínicos, a la vez que bajas pérdidas de luminosidad gracias a sus diferentes lentes.

La innovación de Esdium Sport HE LED le permite ser orientada de una manera muy precisa, con marcador de ángulo y módulos orientables individuales.

Fabricado en aluminio inyectado de alto rendimiento, con cierre de metacrilato (PMMA), LEDs de alto rendimiento y ópticas adecuadas para cada uno de los proyectos necesarios, convirtiéndola en una luminaria de gran robustez y resistencia.



ESDIUM PRO HE

PROYECTOR ALTA EFICIENCIA
HIGH EFFICIENCY FLOOD LIGHT

SOLUCIÓN
INTEGRAL DE
ILUMINACIÓN
LIGHTING
COMPLETE
SOLUTION

15%+
EFICIENTE
EFFICIENT

163
lm./w

CE
MADE IN
SPAIN



Hasta / Up to / 1110w

Fácil instalación y puesta en marcha.
Easy installation and start up.



Regulación / Regulation

Efectos lumínicos y adaptación a las condiciones lumínicas de cada proyecto.
Regulation, different luminic effects and adaptation to different luminics conditions on each Project.



6 ópticas / optics

Para hacer llegar la luz a grandes distancias evitando el deslumbramiento.
6 optics for making come up the light to large distance avoiding the glare.



IP66 - IK08/10

Robusta, se puede pedir opcionalmente con IK10 si la luminaria puede ser golpeada.
Robust, can be ordered with IK10 in case of the luminaire could be hit.



IRC 70-90

Reproducción perfecta de colores.
Perfect color reproduction.



Iluminación para todo tipo de instalaciones
Lighting for all types of installations



Marcador de ángulos para una orientación precisa.

Angle marker for an accurate orientation.



LEDs Osram: 185w, 370w, 555w, 740w, 925w y 1110w. LEDs específicos para retransmisión por TV (5700°K CRI>90).

LEDs Osram 185w, 370w, 555w, 740w, 925w y 1110w. TV broadcasting LED (5700°K CRI>90).



Diseño innovador para una mejor disipación del calor. Drivers integrados en luminaria.

Innovate design for a better heat dissipation. Drivers inside luminaire.



Conector / Distribuidor IP67.

Connector IP67.



Módulos orientables individualmente para un mejor posicionamiento.

Adjustable individual modules for a better positioning.

Ref. 0

Sin óptica secundaria 100°. Without secondary optics 100°.

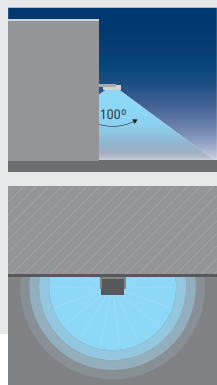

Ref. 1

Óptica simétrica extensiva 41°. Extensive symmetric optics 41°.

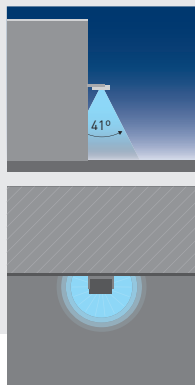

Ref. 2

Óptica simétrica media 32°. Medium symmetric optics 32°.

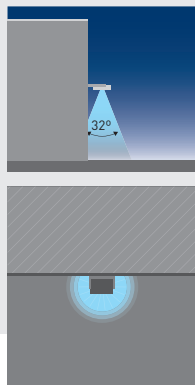

Ref. 3

Óptica simétrica intensiva 21°. Intensive symmetric optics 21°.

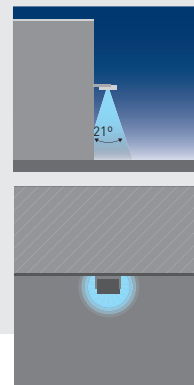

Ref. 4

Óptica asimétrica 2 lados 90° y frontal 50°. Asymmetric optics 2 sides 90° and frontal 50°.

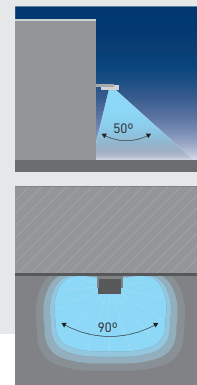

Ref. 5

Óptica asimétrica 2 lados 120° log. y 40° transversal a 25°. Asymmetric optic 2 sides 120° lengthwise and 40° transversal.

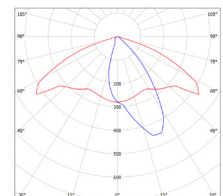
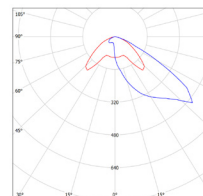
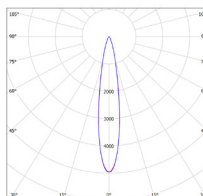
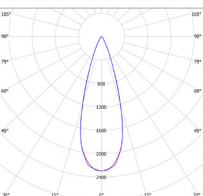
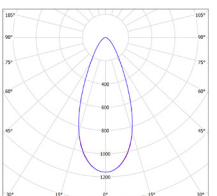
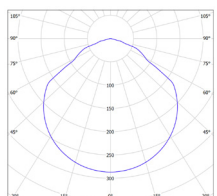
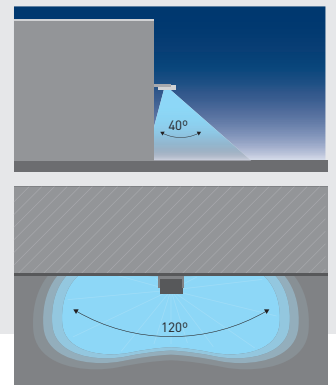

ESDIUM PRO HE

PROYECTOR SUPERFICIE / SURFACE FLOOD LIGHT



Color Base
Base Colour



58



C2424

Disponible en otros colores RAL bajo pedido.
It can be supplied in other RAL colours by request.



Superficie
Surface



185w 740w
370w 925w
555w 1110w



Driver
Incluido
Included



Regul.
Dimmable



21° 50°
32° 110°
41° 120°



3000
4000
5700



>70



60.000h.
L80B10



Aluminio
Aluminium



Diode
Protección
Diode
Protection



IP
66



IK
08/10



Conector
Incluido
Connector
included



+40°
-20°



M1 - 9,8



M2 - 20,2



M3 - 26,3



M4 - 37,4



M5 - 42,5



M6 - 49,5

M1 HORIZONTAL



M2 HORIZONTAL

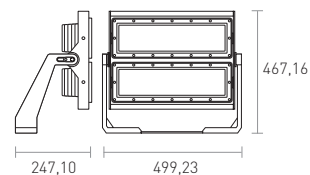
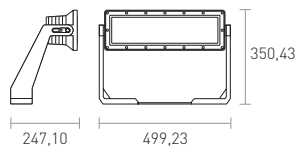

ESDIUM PRO HE / ÓPTICA SIMÉTRICA 110° / SYMMETRIC OPTICS 110°

Ref.	Color / Colour	Módulo / Module	W	[83] lm 3000k	[84] lm 4000k	*[85] lm 5700k
5300 58 18 0 85 HE	Gris / Grey	M1 (1 Un.) Horizontal	185	28842	30233	30233
5300 58 37 0 85 HE	Gris / Grey	M2 (2 Un.) Horizontal	370	57684	60466	60466
5300 58 55 0 85 HE	Gris / Grey	M3 (3 Un.) Horizontal	555	86796	90699	90699
5301 58 55 0 85 HE	Gris / Grey	M3 (3 Un.) Vertical	555	86796	90699	90699
5301 58 74 0 85 HE	Gris / Grey	M4 (4 Un.) Vertical	740	115728	120932	120932
5301 58 92 0 85 HE	Gris / Grey	M5 (5 Un.) Vertical	925	144660	151165	151165
5301 58 11 0 85 HE	Gris / Grey	M6 (6 Un.) Vertical	1110	173592	181398	181398

*Estándar / *Standard

M3 HORIZONTAL

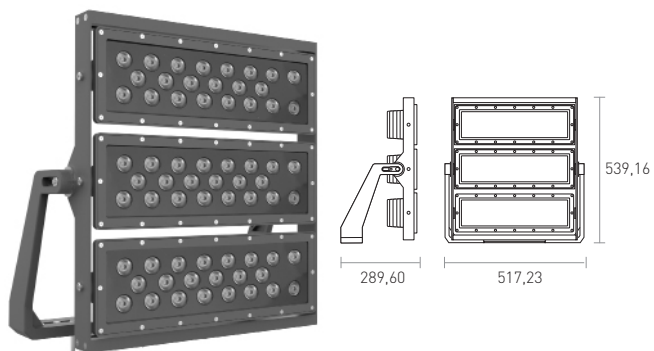

M3 VERTICAL

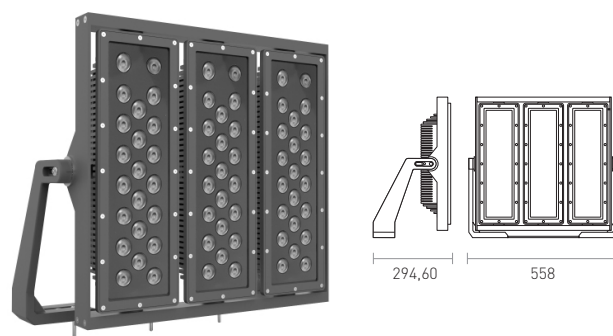

M4 VERTICAL



M5 VERTICAL

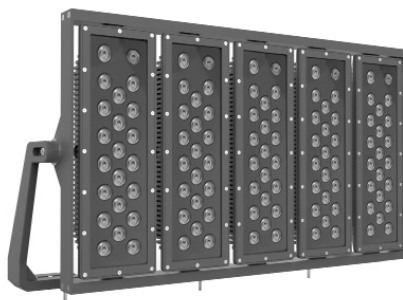

M6 VERTICAL

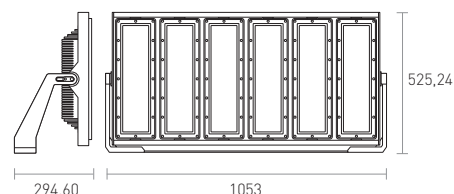
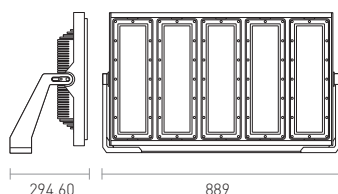
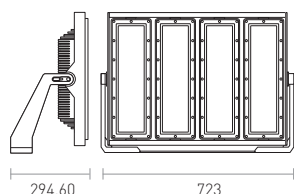

OPCIONES / OPTIONS

O ÓPTICAS / OPTICS

Ref.	Descripción / Description
1	Óptica simétrica extensiva 41° / Extensive symmetric optics 41°
2	Óptica simétrica media 32° / Medium symmetric optics 32°
3	Óptica simétrica intensiva 21° / Intensive symmetric optics 21°
4	Óptica asimétrica 2 lados 90° y frontal 50° Asymmetric optic 2 sides 90° and front 50°
5	Óptica asimétrica 2 lados 120° log. y 40° transversal a 25° Asymmetric optic 2 sides 120° Lengthwise and 40° transversal

D DRIVER

Ref.	Descripción / Description
DR	Driver regulable 1-10 / Driver dimmable 1-10v
DRD	Driver regulable Dali / Driver dimmable Dali
DRPR	Driver programable / Programmable driver

A ACCESORIOS / ACCESSORIES

Ref.	Descripción / Description
IK10	Índice de protección antivandálico / Impact protection index
AM	Pintura especial ambi. marino / Special marine environment paint
ACL	Pintura especial ambi. cloro / Special chlorine environment paint

Los beneficios de las luminarias de LEDs de secom.

- Ahorro energético por su alta eficiencia.
- Ahorro en mantenimiento de luminarias.
- Reproducción cromática (IRC) 80.
- Amplia gama en temperaturas de color.
- Amplia gama de medidas y de colores.
- Posibilidad de regular las luminarias.
- Ópticas de alto rendimiento.
- Fácil montaje e instalación.

¿Por qué trabajar con secom?

- Fabricación nacional de todas sus luminarias de LEDs.
- Disponibilidad de todos los componentes de las luminarias de LEDs (disipadores, LEDs, circuitos, drivers, etc) para reposición.
- El mejor servicio en luminarias de LEDs, debido a la fabricación nacional y al gran stocks de componentes.
- Gran versatilidad en diseño, posibilidad de personalizar luminarias.
- Productos que cumplen la normativa europea vigente.
- LEDs Osram / Samsung.
- Estricto control de calidad.
- Gran inversión en I+D+i para el desarrollo de flujos lumínicos y tecnologías de disipación de temperatura.
- PCB con fechador para verificar la vida media útil garantizada.

The benefits of secom LED lighting fittings.

- Energy-saving because of his high efficiency.
- Saving in maintenance.
- Cromatic reproduction (ICR) 80.
- Wide range of colour temperature.
- Wide range of measures and colours.
- Possibility of dimming the lighting fitting.
- High output optics.
- Easy installation.

Why should you work with secom?

- Own production of all our LED light fitting.
- Availability of all components of LEDs fittings (heat sink, LEDs, drivers, etc.) for replacement.
- The best service in the LEDs fitting due to the production in our own production plants of and a large stock of components.
- Flexibility in design and possibility of customize the fittings.
- The products comply with European standards.
- Components are Osram / Samsung.
- Strict quality control.
- Big investment in R&D on development of luminus fluxes and temperature dissipation technologies.
- PCB with its production date for life span control.



secom

here comes the light

Polígono Industrial La Estrella. C/ Marte 18-21.
30500 Molina de Segura. Murcia. Spain
Tlf. 968 80 12 11 / Fax 968 89 10 48
secom@secom.es

Dpto. Exportación.
Tlf. +34-968-80 18 00
Fax. +34-968-89 10 48
export@secom.es



www.secom.es

