



Konak City LED

luminaria para vial
street luminaires

secom
here comes the light



Konak City LED

Konak City LED es una luminaria con un innovador diseño y una estética optimizada para su uso como luminaria para vial, que consigue altas prestaciones de robustez y fiabilidad.

La calidad de los componentes electrónicos usados para su fabricación, el cierre de policarbonato transparente y un cuerpo de inyección de aluminio que favorece la disipación del calor, han dado lugar a una luminaria de gran rendimiento lumínico, robustez y durabilidad.

Esta luminaria tiene la flexibilidad suficiente para adaptarse a cualquier superficie a iluminar, con posibilidad de suministrarse en potencias de 40W, 100W, 150W, 200W y 250W; dos ángulos de apertura 80° y 150° y varios tipos de regulación que permiten un mayor ahorro de consumo.

Incorpora LEDs de protección que aseguran que la cadena restante de LEDs continuará funcionando si un solo LED no lo hace. La versión programable se suministra con sonda NTC para proteger la luminaria de sobre temperaturas puntuales.

Konak City LED is a luminaire with an innovative design where the esthetic has been optimized for using street luminaire, getting a high performance in strength and reliability.

With a huge luminous efficiency because of its transparent polycarbonate closing, the body made in aluminum injection and the quality of the electronic components.

This luminaire has the great flexibility to adapt to any surface, with the possibility of been supplied in different powers: 40W, 100W, 150W, 200W and 250W; two different opening angle, 80° and 150° and different types of regulation allowing greater power saving.

Includes protection LEDs ensuring that the remaining string of LEDs keep working if one LED does not. The programmable version it is supplied with NTC sensor to protect the luminaire against occasional overtemperatures.

Grado de protección **IP65** / Índice de protección antivandálico **IK08**
 Protection degree **IP65** / Impact protection index **IK08**



Konak city LED vertical - Óptica simétrica 150°
 Konak city LED vertical - Symmetric optics 150°

Incluye driver y lámparas LEDs / Includes driver and LEDs lamp

Ref.	Color / Colour	Lumens	W
4174 58 40 85	Gris / Gray	5832	40w
4174 58 10 85	Gris / Gray	13608	100w
4174 58 15 85	Gris / Gray	21384	150w
4174 58 20 85	Gris / Gray	28512	200w
4174 58 25 85	Gris / Gray	34020	250w

* Se suministra de manera estándar con LED 5700°K.
 * Standardly supplied with 5700°K LED lamp.

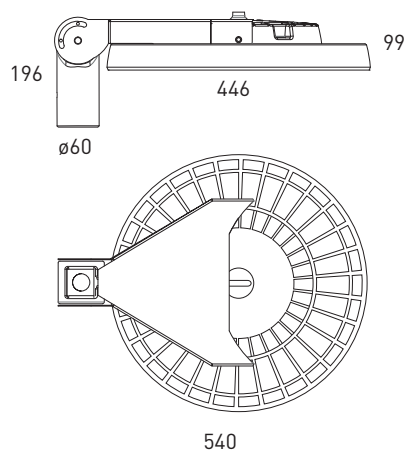

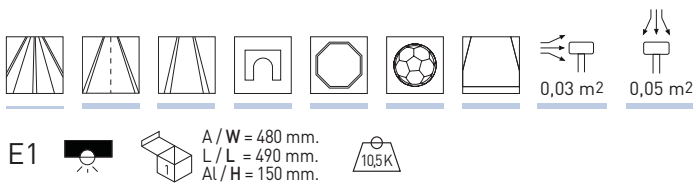

OPCIONES / OPTIONS

Incremento respecto al driver / Rough price increase of accessories

Ref. DR	Driver regulable 1 - 10v / Dimmable driver 1 - 10v
Ref. DRD	Driver regulable Dali / Dimmable driver Dali
Ref. DRPR	Driver programable / Programmable driver
Ref. DRPNTC	Driver prog. y sonda Tª NTC / Prog. driver & NTC control
Ref. DRC	Regulación en cabecera / Regulation at the head
Ref. 3409	Leds con óptica simétrica 48° / LEDs with symmetric optics 48°
Ref. 3407	LEDs con óptica asimétrica / LEDs with asymmetrical optics

Incremento por óptica / Rough price increase of optics

Ref. 3408	Óptica simétrica 80° / Symmetric optics 80°
Ref. 3409	Leds con óptica simétrica 48° / LEDs with symmetric optics 48°
Ref. 3407	LEDs con óptica asimétrica / LEDs with asymmetrical optics
Ref. AMB	LED Ámbar / Amber LED

Incremento por accesorios / Rough price increase of accessories

Ref. AM	Pintura especial ambiente marino / Special marine environment paint
Ref. IK10	Índice de protección antivandálico / Impact protection index

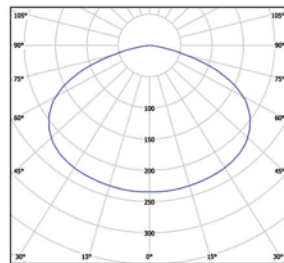

Óptica simétrica de 150°
Symmetric optical 150°

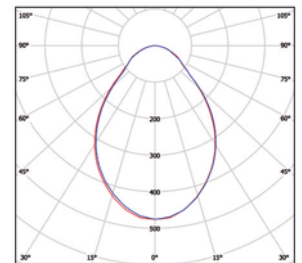

Óptica simétrica de 80°
Symmetric optical 80°

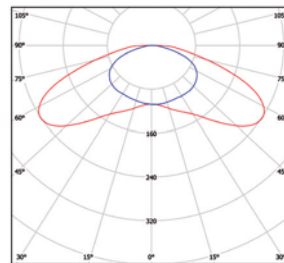

Ref. 3407 Óptica asimétrica de 150°
Asymmetrical optical 150°

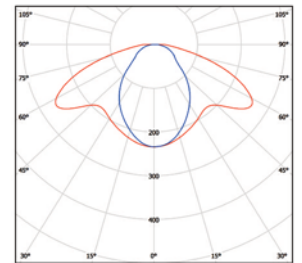

Ref. 3407 Óptica asimétrica de 80°
Asymmetrical optical 80°

OPCIONES LED / OPTIONS LED

		Ref. 83	Ref. 84	Ref. 85
CRI>80 / Temp. de color / Colour temperature	W	3000°K	4000°K	5000°K
Lúmenes / Lumens Osram Oslon SSL	40w	4860	5313	5832
	100w	11340	12399	13608
	150w	17820	19484	21384
	200w	23760	25978	28512
	250w	28350	30996	34020

Los beneficios de las luminarias de LEDs de secom.

- Ahorro energético por su alta eficiencia.
- Ahorro en mantenimiento de luminarias.
- Reproducción cromática (IRC) 80.
- Amplia gama en temperaturas de color.
- Amplia gama de medidas y de colores.
- Posibilidad de regular las luminarias.
- Ópticas de alto rendimiento.
- Fácil montaje e instalación.

¿Por qué trabajar con secom?

- Fabricación nacional de todas sus luminarias de LEDs.
- Disponibilidad de todos los componentes de las luminarias de LEDs (disipadores, LEDs, circuitos, drivers, etc) para reposición.
- El mejor servicio en luminarias de LEDs, debido a la fabricación nacional y al gran stocks de componentes.
- Gran versatilidad en diseño, posibilidad de personalizar luminarias.
- Productos que cumplen la normativa europea vigente.
- Componentes Osram Duris E5.
- Estricto control de calidad.
- Gran inversión en I+D+i para el desarrollo de flujos lumínicos y tecnologías de disipación de temperatura.
- PCB con fechador para verificar la vida media útil garantizada.

The benefits of secom LED lighting fittings.

- Energy-saving because of his high efficiency.
- Saving in maintenance.
- Cromatic reproduction (ICR) 80.
- Wide range of colour temperture.
- Wide range of measures and colours.
- Possibility of dimming the lighting fitting.
- High output optics.
- Easy installation.

Why should you work with secom?

- Own production of all our LED light fitting.
- Availability of all components of LEDs fittings (heat sink, LEDs, drivers, etc.) for replacement.
- The best service in the LEDs fitting due to the production in our own production plants of and a large stock of components.
- Flexibility in design and possibility of customize the fittings.
- The products comply with European standards.
- Components are Osram Duris E5.
- Strict quality control.
- Big investment in R&D on development of luminus fluxes and temperature dissipation technologies.
- PCB with its production date for life span control.

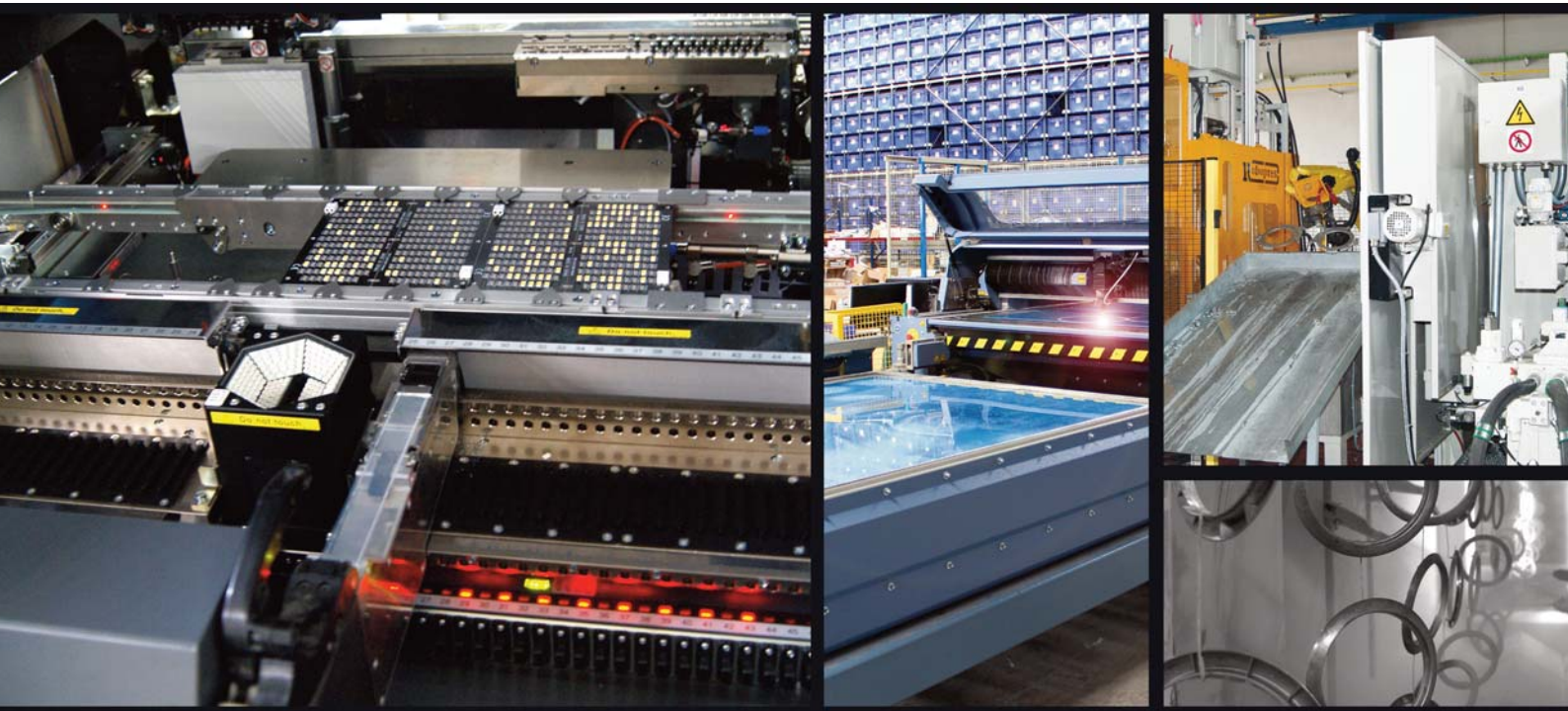

secom
here comes the light

Polígono Industrial la Estrella. C/ Marte 18-21
0500 Molina de Segura (Murcia) Spain - Buzón de correos nº11
Tlf.: 968 80 12 11 - Fax.:968 89 10 48 - secom@secom.es
Dpto.Exportación. Tlf.: ++34-968-80 18 00. Fax.: ++34-968-89 10 48
export@secom.es



www.secom.es

