

**secom**  
here comes the light

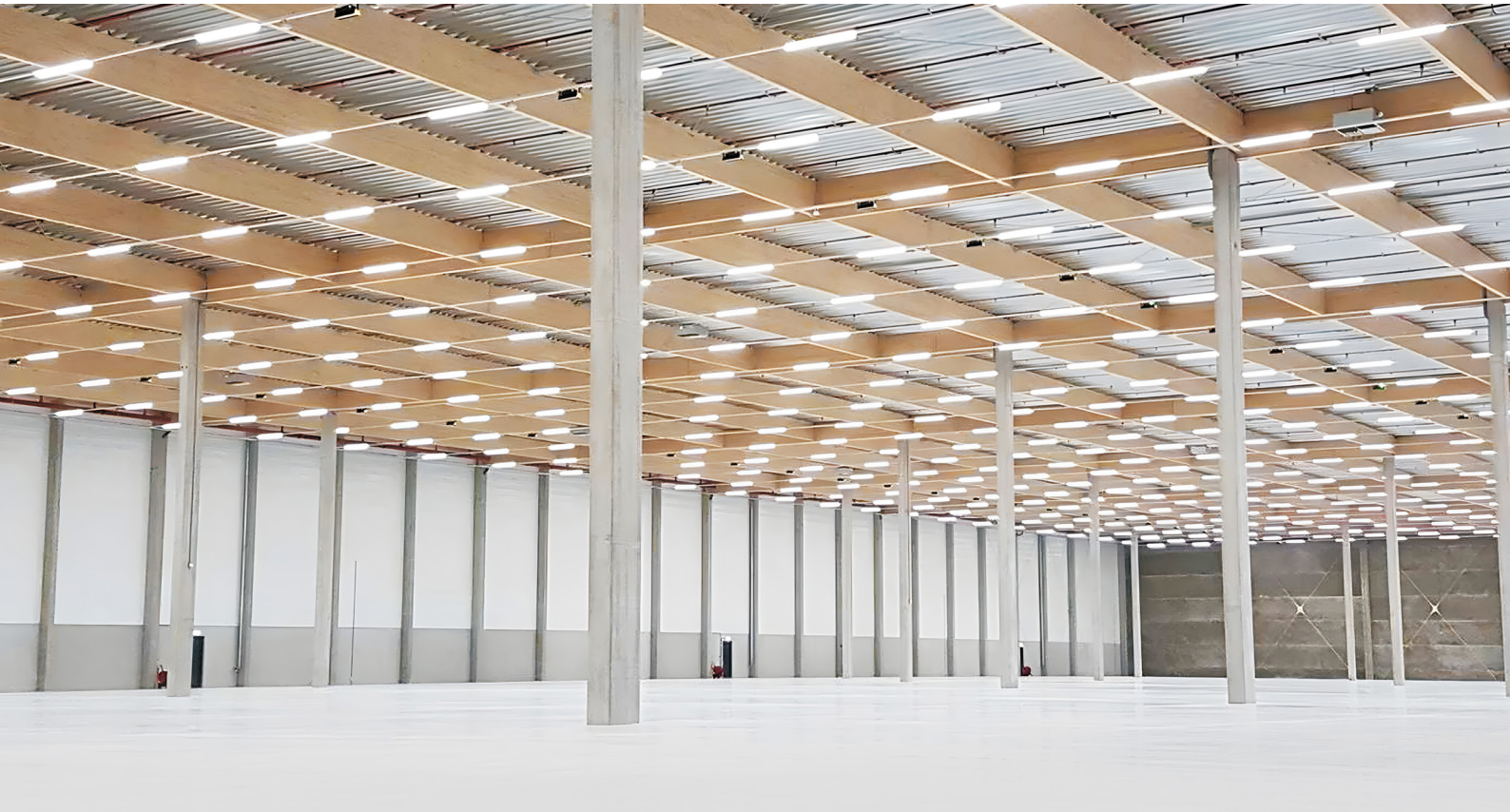

# TECLINE

TRACK

HIGH EFFICIENCY  
LIGHTING SYSTEM



[www.secom.es](http://www.secom.es)

# TECLINE TRACK



HIGH LIGHTING LIGHTING SYSTEM EFFICIENCY

**TECLINE TRACK** is a highly efficient continuous in-line lighting system, a system developed by the Secom Iluminación team with the aim of minimising installation time.

Its careful design makes installation and maintenance extremely easy and tool-free.

LED	⚡	Hz	W	✓	Optional DALI CASAMBI	IP	IK	°K	CRI	👁️	🌡️	⚙️	🕒	📦	PF
2835 MID POWER	230V ac	50/60	66 System 69 System	✓	Optional DALI CASAMBI	20	06	3000K 4000K	>80	<19 Optic 30°	0° +35°	30° 60° 90° 120° A25 DA25	50,000h. (L80B10) 50°C	1,68 for 1.437mm.	0,97

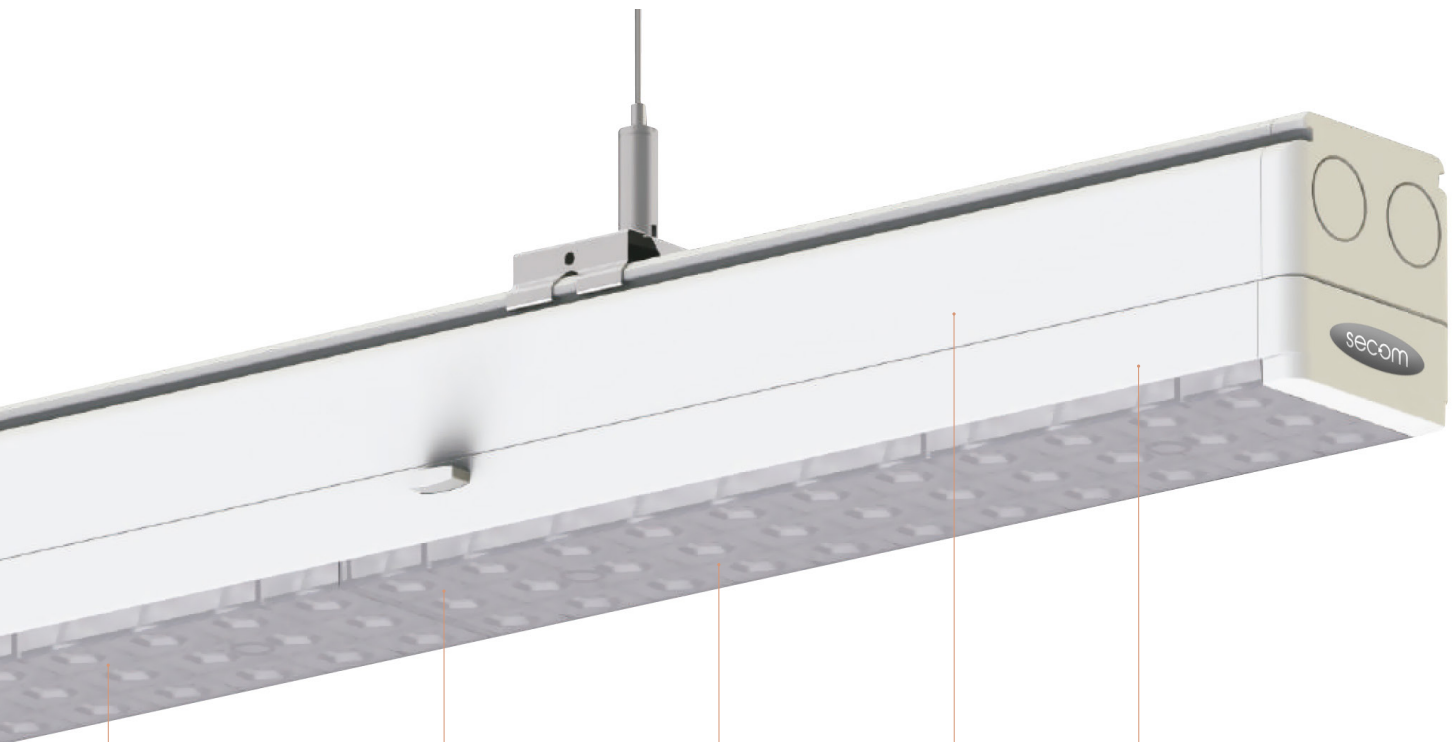

## LED

High efficiency LED.  
157 Lm/W, high light intensity.  
Low light decay.  
Uniform luminous flux.



Choice of 6 different optics depending on the project to lighting.

## DRD

DRIVER DALI ADJUSTABLE  
Optional



CASAMBI  
Option

BIG FLEXIBILITY OF SERVICES



EASY INSTALLATION



5 YEARS GUARANTEE



## FAST CONNECTION

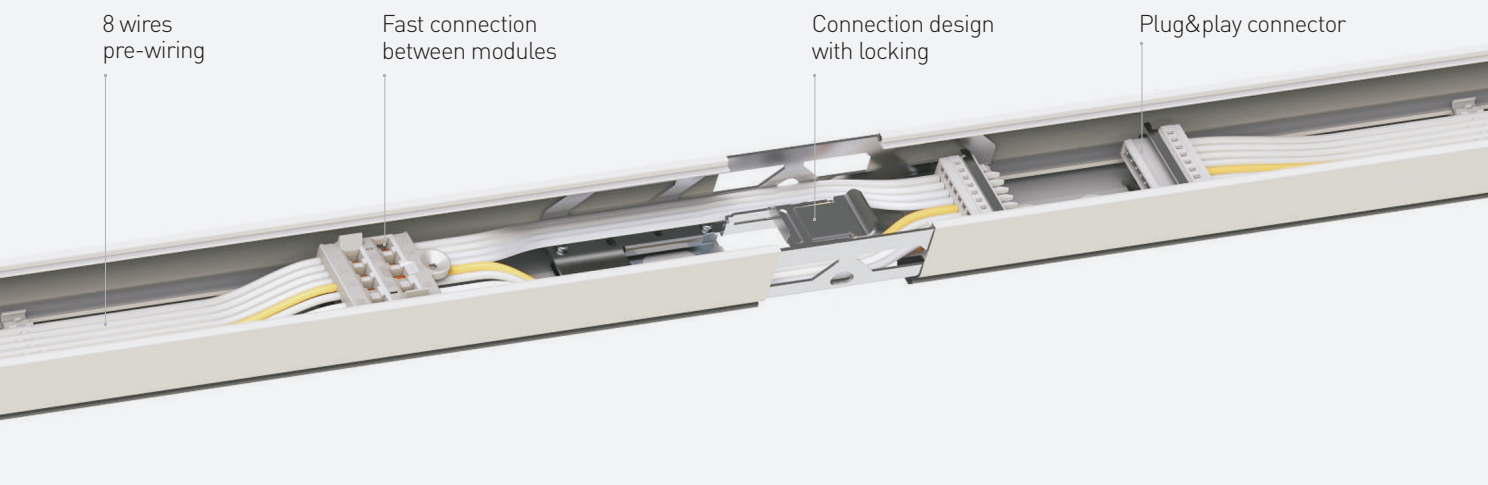

## CONTINUOUS LINE SYSTEM DESIGNED TO REDUCE COSTS

**TECLINE TRACK** aims to minimise installation time with a design that makes installation and maintenance extremely easy and tool-free.

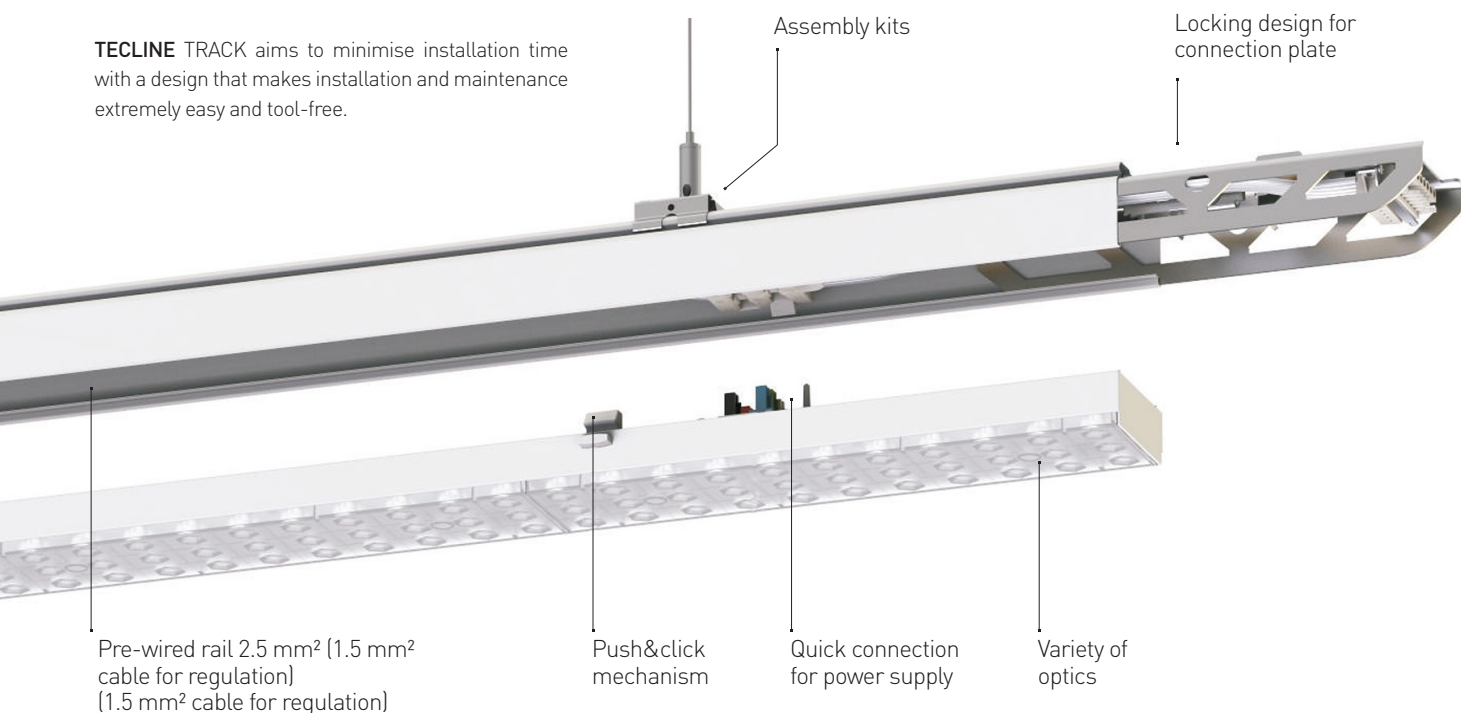

## MAX. NO. OF EQUIPMENT CARRIERS PER SPREADER

	CABLE	PROTECTION	DIFFERENTIAL	Nº OF EQUIPMENT CARRIERS PER PHASE
▶	2,5 mm. <sup>2</sup>	16A	Type B	28 unds.
▶	2,5 mm. <sup>2</sup>	16A	Type C	44 unds.
▶	2,5 mm. <sup>2</sup>	10A	Type B	19 unds.
▶	2,5 mm. <sup>2</sup>	10A	Type C	28 unds.



## TOOL-FREE INSTALLATION

**TECLINE TRACK**, requires minimal wiring connections compared to an installation with conventional individual luminaires, which drastically reduces costs and labour expenses.



Individual luminaires  
conventional installation

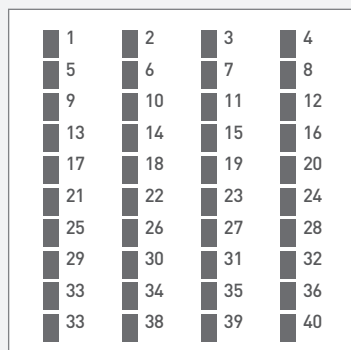

Luminaires: 40

Wiring points: **40**

Installation with  
**TECLINE TRACK**

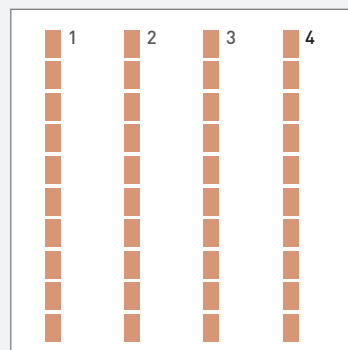

Luminaires: 40

Wiring points: **40**

## INNOVATIVE OPTICAL DESIGN FOR LESS LIGHT LOSS AND OPTIMAL EFFICIENCY



## MORE ENERGY EFFICIENCY, INNOVATIVE DESIGN OF DIP SWITCHES INTEGRATED.

**TECLINE TRACK**, new generation luminaire for a unique lighting system improved with higher luminous efficiency. 8 different wattages from 25-75W (for the non-dimmable version) selectable thanks to the DIP switch on the driver.

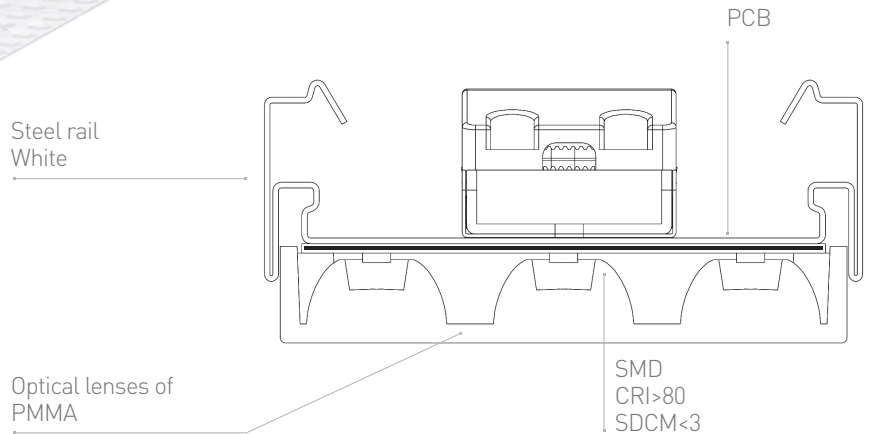
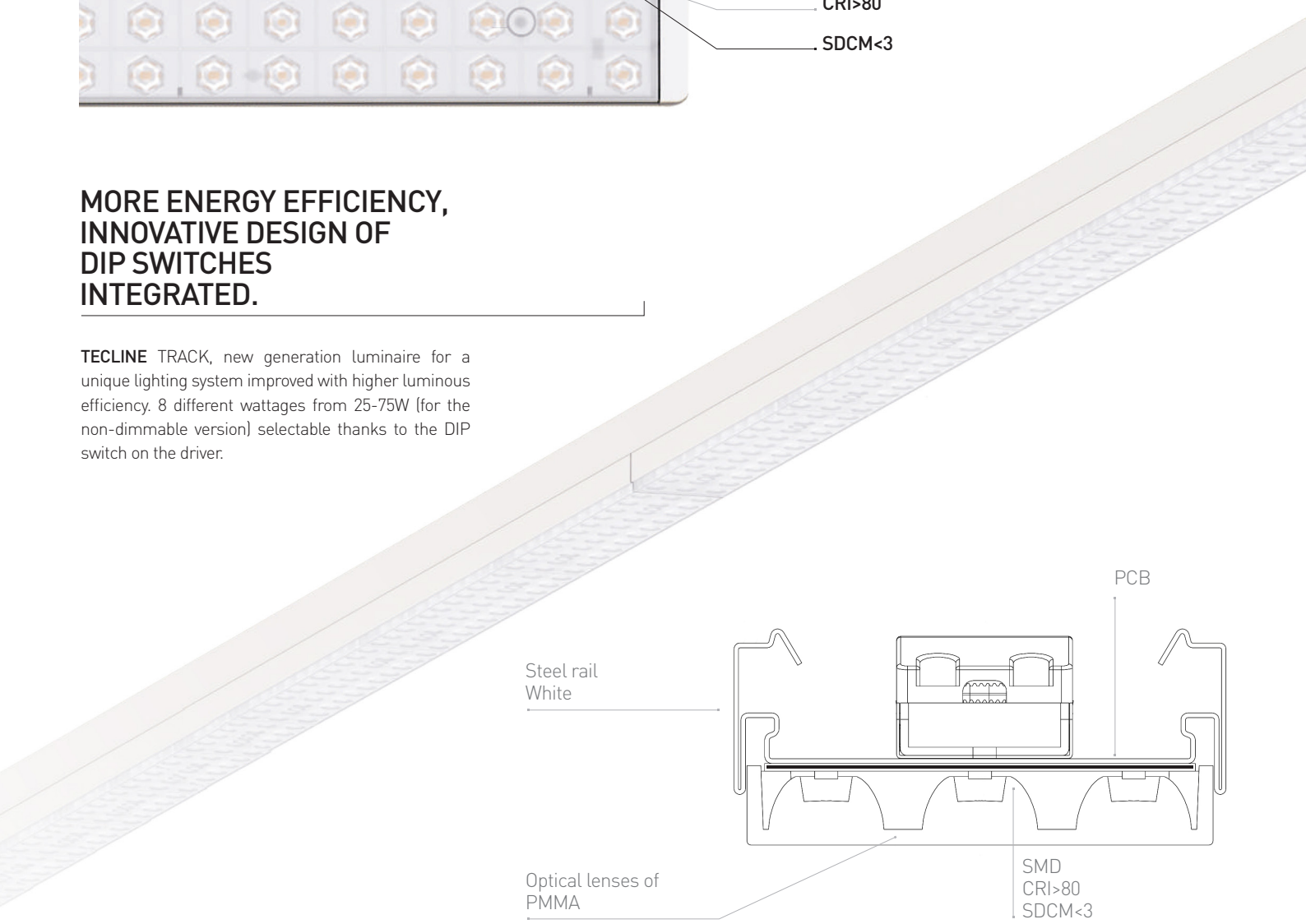

DALI dimmable driver with DALI-2 interface

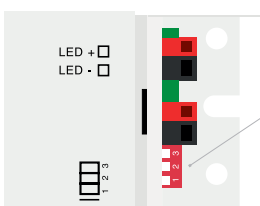

PI	Po	Irated	1	2	3
75w	69w	440 mA			
65w	60w	380 mA	ON	-	-
55w	50w	320 mA	-	ON	-
45w	41w	270 mA	ON	ON	-
40w	37w	240 mA	-	-	ON
35w	32w	210 mA	ON	-	ON
30w	27w	180 mA	-	ON	ON
25w	22w	140 mA	ON	ON	ON

## DIMENSIONS

### TRACK

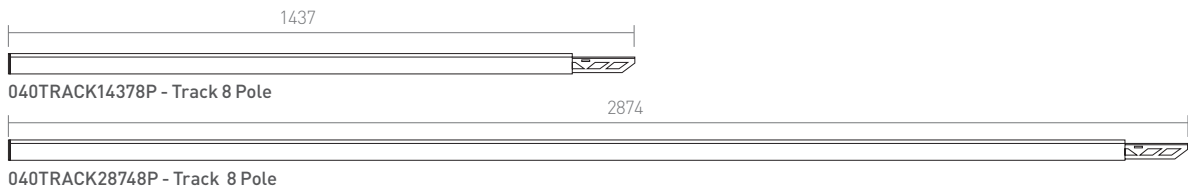

### LUMINAIRE

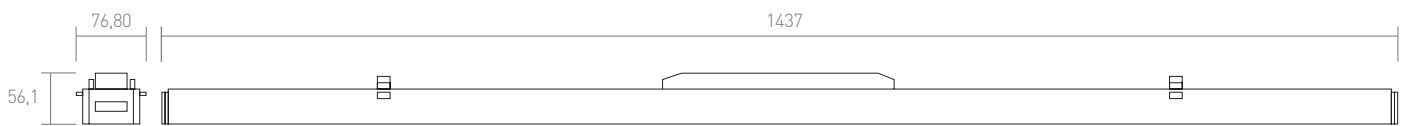



## REFERENCES

### TECLINE / TRACK

Ref.	Colour	Dimensions	Kg
<b>040 TRACK 1437 8P</b>	White	1437x65x25	1.785
<b>040 TRACK 2874 8P</b>	White	2874x65x25	3.305

### TECLINE / LED module / not adjustable (DIP SWICHT)







Ref.	Colour	Opticians	Dimensions	W LED	Lm. LED	W System	Lm. System	Kg.	Colour Temp.
<b>S04001588330</b>	White	30°	1437x65x25	<b>58</b>	12.177	<b>66</b>	10.148	1.685	3000K
<b>S04001588430</b>	White	30°	1437x65x25	<b>58</b>	12.819	<b>66</b>	10.683	1.685	4000K
<b>S04001588360</b>	White	60°	1437x65x25	<b>58</b>	12.177	<b>66</b>	9.735	1.685	3000K
<b>S04001588460</b>	White	60°	1437x65x25	<b>58</b>	12.819	<b>66</b>	10.248	1.685	4000K
<b>S04001588390</b>	White	90°	1437x65x25	<b>58</b>	12.177	<b>66</b>	9.639	1.685	3000K
<b>S04001588490</b>	White	90°	1437x65x25	<b>58</b>	12.819	<b>66</b>	10.147	1.685	4000K
<b>S040016383120</b>	White	120°	1437x65x25	<b>63</b>	10.230	<b>69</b>	8.525	1.685	3000K
<b>S040016384120</b>	White	120°	1437x65x25	<b>63</b>	10.768	<b>69</b>	8.974	1.685	4000K
<b>S040015883A25</b>	White	A25	1437x65x25	<b>58</b>	12.177	<b>66</b>	9.447	1.685	3000K
<b>S040015884A25</b>	White	A25	1437x65x25	<b>58</b>	12.819	<b>66</b>	9.944	1.685	4000K
<b>S040015883DA25</b>	White	DA25	1437x65x25	<b>58</b>	12.177	<b>66</b>	9.900	1.685	3000K
<b>S040015884DA25</b>	White	DA25	1437x65x25	<b>58</b>	12.819	<b>66</b>	10.422	1.685	4000K

### TECLINE / LED module / DALI dimmable driver

Ref.	Colour	Opticians	Dimensions	W LED	Lm. LED	W System	Lm. System	Kg.	Colour Temp.
<b>S04001588330DRD</b>	White	30°	1437x65x25	<b>58</b>	12.177	<b>66</b>	10.148	1.685	3000K
<b>S04001588430DRD</b>	White	30°	1437x65x25	<b>58</b>	12.819	<b>66</b>	10.683	1.685	4000K
<b>S04001588360DRD</b>	White	60°	1437x65x25	<b>58</b>	12.177	<b>66</b>	9.735	1.685	3000K
<b>S04001588460DRD</b>	White	60°	1437x65x25	<b>58</b>	12.819	<b>66</b>	10.248	1.685	4000K
<b>S04001588390DRD</b>	White	90°	1437x65x25	<b>58</b>	12.177	<b>66</b>	9.639	1.685	3000K
<b>S04001588490DRD</b>	White	90°	1437x65x25	<b>58</b>	12.819	<b>66</b>	10.147	1.685	4000K
<b>S040016383120DRD</b>	White	120°	1437x65x25	<b>63</b>	10.230	<b>69</b>	8.525	1.685	3000K
<b>S040016384120DRD</b>	White	120°	1437x65x25	<b>63</b>	10.768	<b>69</b>	8.974	1.685	4000K
<b>S040015883A25DRD</b>	White	A25	1437x65x25	<b>58</b>	12.177	<b>66</b>	9.447	1.685	3000K
<b>S040015884A25DRD</b>	White	A25	1437x65x25	<b>58</b>	12.819	<b>66</b>	9.944	1.685	4000K
<b>S040015883DA25DRD</b>	White	DA25	1437x65x25	<b>58</b>	12.177	<b>66</b>	9.900	1.685	3000K
<b>S040015884DA25DRD</b>	White	DA25	1437x65x25	<b>58</b>	12.819	<b>66</b>	10.422	1.685	4000K



## TECLINE OPTICS OVERVIEW

	INTENSIVE	MEDIA	EXTENSIVE	STANDARD	ASYMMETRIC	DOUBLE ASYMMETRIC
						
	30°	60°	90°	120°	A25	DA25
Recommendation Height	6-12 m.	3-7 m.	3-6 m.	2-4 m.	2-4 m.	2-4 m.
INDUSTRY	•	•	•	•	•	•
RETAIL	•	•	•	•	•	•
OFFICES	•	•	•	•	•	•
EDUCATION	•	•	•	•	•	•

GENERATOR REFERENCE **TECLINE TRACK**

Product Ref.	Dimensions	No. of poles
S040	1437 (1.437 mm.)	8P (8Poles)
	2874 (2.874 mm.)	
↓	↓	↓
S040	1437	8P
E.g. configuration ref. S04014378P		

GENERATOR REFERENCE **TECLINE LED MODULE**

Product Ref.	Luminaire colour	Power W	Colour Temp.	Optics	Driver reg. DALI
S040	01 (Blanco)	58 <small>(58w-30°/60°/90°/A25/DA25)</small>	83 (3.000K)	30 (30°)	- (ON/OFF)
		63 <small>(63w - 120°)</small>	84 (4.000K)	60 (60°)	DRD <small>(Driver regulable DALI 2.0)</small>
				90 (95°)	LCS <small>(CASAMBI)</small>
				120 (125°)	
				A25 <small>(Asymmetric)</small>	
				DA25 <small>(Double asymmetric)</small>	
↓	↓	↓	↓	↓	↓
S040	01	58	83	30	DRD
E.g. configuration ref. S04001588330DRD					

## TECLINE COMPLEMENTS

S040SUSPCEIL	Chain suspension	S040ENDBOX	End trim
S040SUSPFIX	Cable suspension	S040SENSORDALI	DALI sensor
S040SURF	Surface	S040SENSORWAVE	Microwave Sensor
S040ENDCAPS	Cover start of section	S040X1P/2P/3P/4P/5P	X-joint connector
S040ACINPUT8P	Connection	S040T1P/2P/3P/4P/5P/6P/7P	T-joint connector
S040ACINPUTBOX8P	Feeder	S040L1P/2P/3P/4P	L-joint connector
S040ACLCSINPUTBOX8P	CASAMBI Feeder	S040TRACKMODULE	Track adapter with integrated three-phase system
SPT01	Cable gland	S040TRACKMODULEDRD	Track adaptor with integrated three-phase / DALI system
S040COVER	Blind section		

## INSTALLATION SYSTEMS



Chain suspension  
Ref. 040SUSCEIL  
Kit 2 pcs. / 2m.

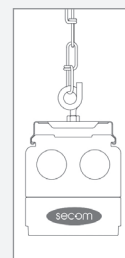
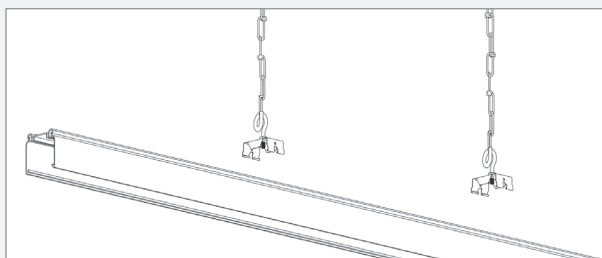

\* Minimum 2 units per track.



Suspension cable  
Ref. 040SUSPFIX  
Kit 2 pcs. / 2m.

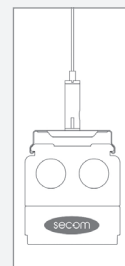
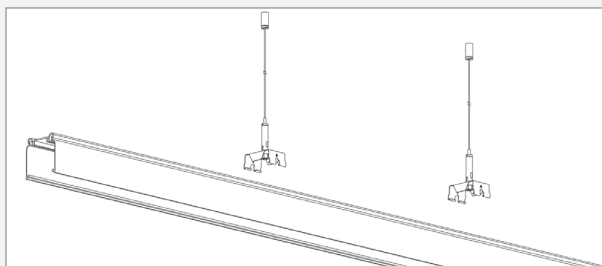

\*Minimum 2 units per lane.

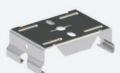

Surface  
Ref. 040SURF  
Kit 2 pcs.

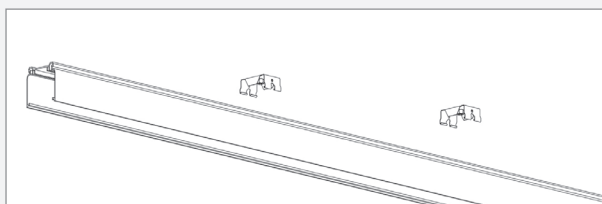

\*Minimum 2 units per lane.

## ACCESSORIES



Cover start of section  
Ref. 040ENDCAPS  
2 pcs.



AC Connection  
Ref. 040ACINPUT8P

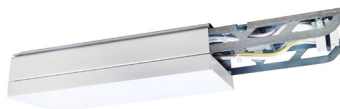

Feeder  
Ref. 040ACINPUTBOX8P  
Alimentador LCS CASAMBI  
Ref. 040ACLCSINPUTBOX8P



Cable gland  
Ref. PT01



Blind section 1437 mm.  
Ref. 040COVER



Rail adapter with integrated  
integrated three-phase 1437 mm.  
Ref. 040TRACKMODULE

Track adapter with integrated  
integrated three-phase system 1437  
mm / DALI  
Ref. 040TRACKMODULEDRD



End trim  
Ref. 040ENDBOX



Blind section with DALI sensor  
Ref. 040SENSORDALI

Blind section with Microwave sensor  
Ref. 040SENSORWAVE

## UNIONS

### L JOINTS



Ref. 040L1P



Ref. 040L2P



Ref. 040L3P



Ref. 040L4P

### T JOINTS



Ref. 040T1P



Ref. 040T2P



Ref. 040T3P



Ref. 040T4P



Ref. 040T5P



Ref. 040T6P



Ref. 040T7P

### X JOINTS

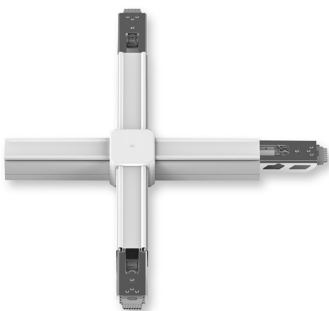

Ref. 040X1P

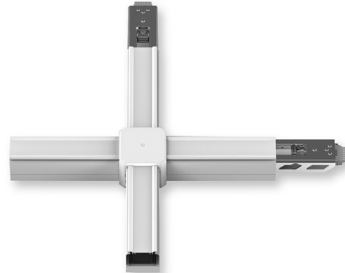

Ref. 040X2P

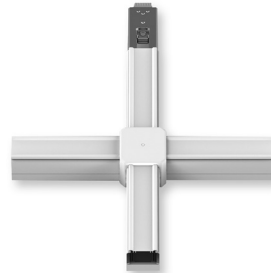

Ref. 040X3P



Ref. 040X4P

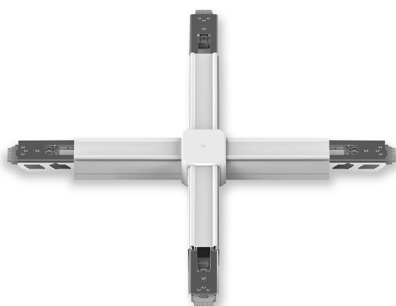

Ref. 040X5P



## TECLINE IoT Solution CASAMBI

When it comes to managing and controlling lighting, ease of use by the user must be paramount.

Based on this premise, at Secom we offer you the LCS Casambi integrated system, this system allows the end user to control and manage all the lighting wirelessly (Bluetooth 4.0) from the free Casambi app, available on both Android and IOS and with bluetooth communication.

The app allows you to create rooms, switch on, switch off and dim the lighting at any time with a single touch of the screen



### LIGHTING CONFIGURATION WITH LCS CASAMBI SOLUTION



**LCS CASAMBI FEEDER**  
Ref. 040ACLC SINPUBOX8P



**TRACK**  
Ref. 040TRACK14378P 1437x65x25  
Ref. 040TRACK28748P 2874x65x25



**LED MODULE**  
Ref. 04001XX8XLCS

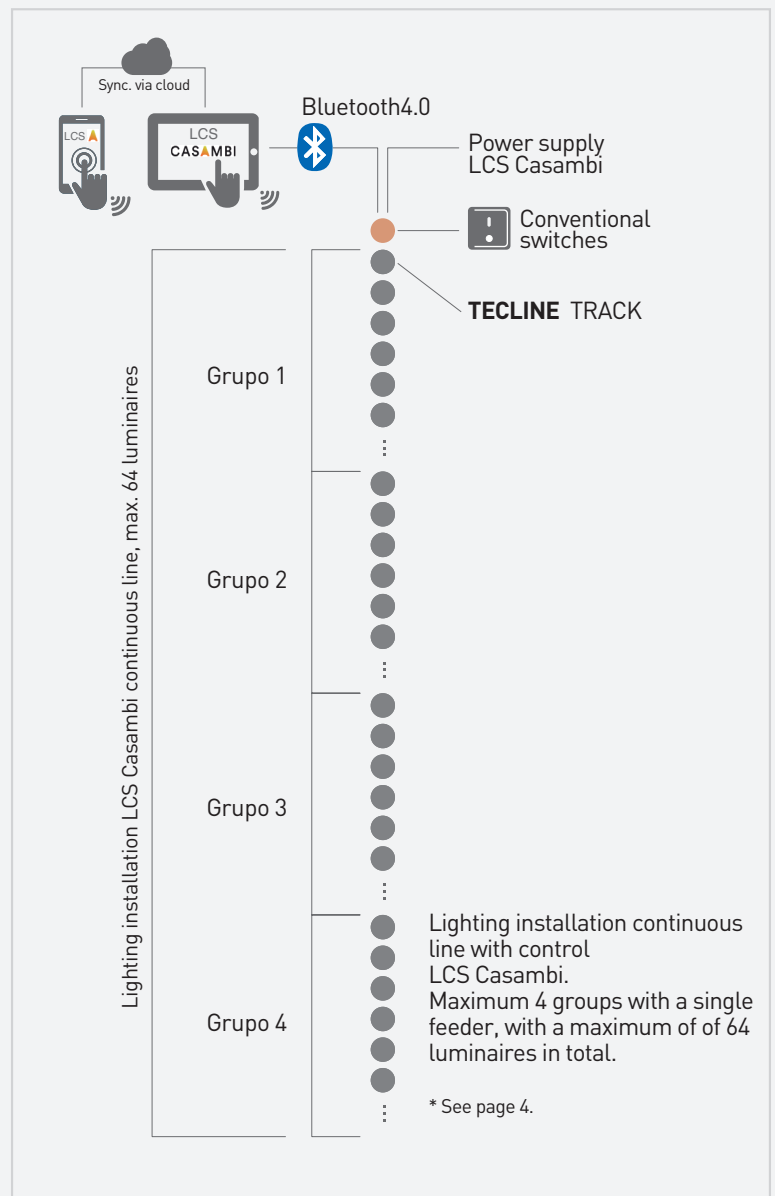

### POSIBILIDADES

Point to point (on request/economic study)  
Tailor-made grouping (under study).

## VERSATILIDAD

**TECLINE TRACK**, is an electrified rail lighting system in a continuous line. It is a highly versatile system thanks to the option of incorporating different luminaires such as projectors, emergency lighting and even motion sensors, all mounted on the rail adapter. Plan your lighting system according to your needs.



### WIRING DIAGRAM FOR EMERGENCY LUMINAIRES EMERGENCY LUMINAIRES FOR RAIL ADAPTER

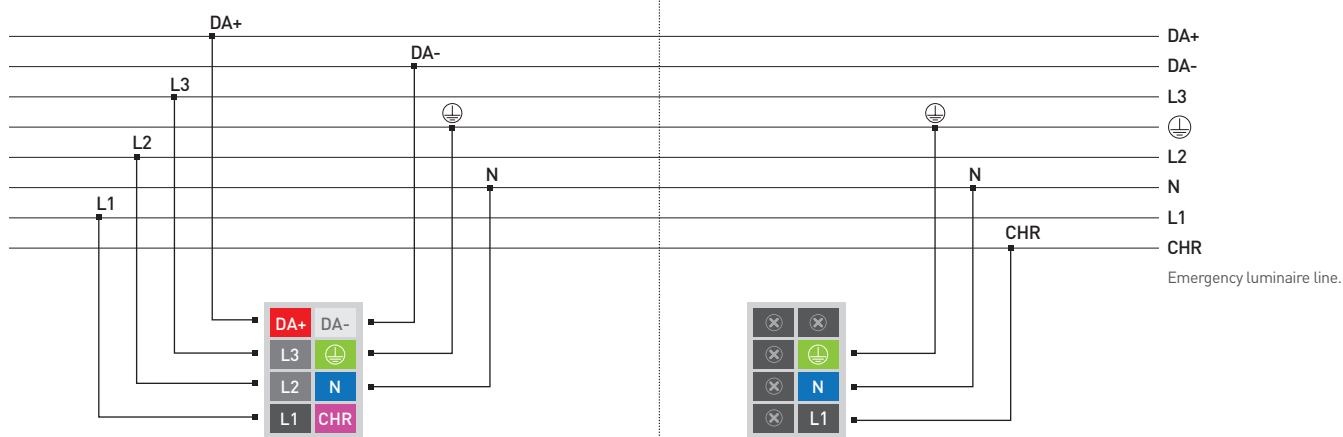

Standard LED module connection.

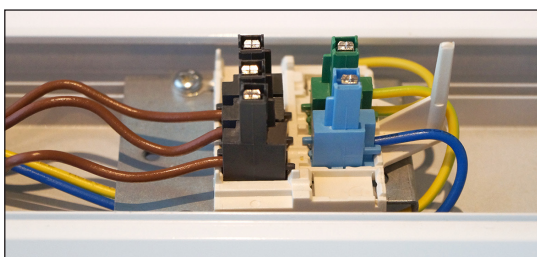

#### Conexión para adaptador carril para luminarias de emergencia.

- (1) Dislodge PINs L1, L2 and L3 from the junction box, keep PIN earth and PIN neutral fixed.
- (2) Disconnect phase PIN (L1) and reconnect to the CHR slot.
- (3) Select phase (L1) in the luminaire.

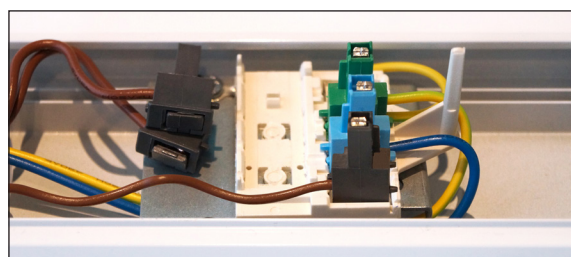



ure

13 | Oeillet de rideau  
Rideau occultant  
Ruflette

Carta de  
seguretat  
→

15 | Escala de color  
de  
Vitrage

Éclairage

17 | Bous de l'ancien  
de l'art  
Joli et petit

11 |

12 |

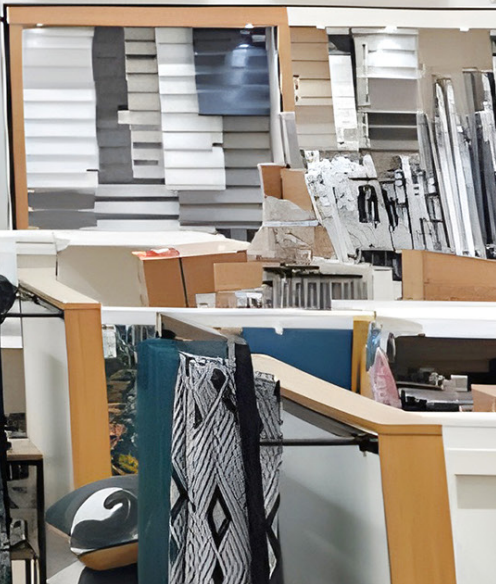

secom  
here comes the light



[www.secom.es](http://www.secom.es)